



Food & Beverage

Process Automation and Instrumentation

Reliable processes thanks to perfect integration of all components

www.usa.siemens.com/pi

SIEMENS



Table of Contents

Your challenge is our passion	03
Your partner for best quality	04
Sugar	06
Dairy	08
Brewing	10
Soft drinks	12
Selected technologies	14
Flow, pressure, temperature, valve positioning, weighing and dosing, level	
Distributed Control Systems	23
Totally Integrated Automation	24
Industrial Identification	26
Services and support	27
Process Automation and Instrumentation product range	28



Your challenge is our passion

Changing demographics, new consumer tastes, quality expectations, evolving regulation and price constraints pressure on profit margins. The food and beverage sector faces a range of challenges. The demands of big retailers are increasing. Concerns about food safety are always present. The need for faster and more flexible supply lines is intensifying. Product tracking and tracing are becoming increasingly important.

In this environment, competitive advantage is the number one priority: minimizing the total cost of ownership while maintaining flexible offers. With the right automation in place, companies can turn competition and pressure to their advantage.

Gaining control with measurements is right at the heart of food and beverage manufacturing. It is key to unlocking value, enhancing quality, leveraging flexibility, boosting profitability and maintaining reliability. Whether it is the technology to break through bottlenecks, improve quality or to provide early warning of failure, we have the knowledge of industry processes and the applications to keep customers on the road to success.

Siemens delivers world-class capabilities to meet the challenges faced by the food and beverage industry. Siemens is able to address the full range of process instrumentation requirements. Our global reach and extensive product portfolio enables us to meet your development needs and requirements.

When you partner with Siemens, you have the right ingredients for success:

- A perfectly coordinated and harmonized portfolio of products and solutions for every process step in the value chain
- A single concept for seamless integration of the entire company to master productivity, quality and supply challenges
- Fewer different components – simplifying the inventory of spare parts and ensuring highly efficient maintenance
- The assurance of a world-class brand delivering leading-edge automation technology
- People who understand your industry needs and can configure solutions to match your operating conditions

Your partner for efficient processes

Food is the energy of life. That is why trust and confidence play such an important part in the food and beverage market. Yet the issue of trust and confidence is not confined to questions about quality and safety. Product availability is also crucial in winning the battle for shelf space.







Whatever your sector of the market is – whether you are a food and beverage company or an original equipment manufacturer (OEM) – you can be assured that Siemens quality and results will help you meet your business and customer goals.

The Siemens approach:

- An emphasis on user-friendly products – for safer, faultless operation
- A high degree of product safety – through maximum process transparency
- Optimal resource efficiency – through innovative platform concepts
- More flexibility – for faster and safer production changeover
- Increased productivity – with optimal solutions for the operating phase

Customer benefits:

- Fast commissioning, short ramp-up times
- Low total cost of ownership
- Continuous process through innovative service and support concepts
- Traceability to ensure manufacturing quality through completely integrated production
- Maximum compatibility and innovation providing you with confidence in the future

- Level 
- Flow 
- Pressure 
- Temperature 
- Positioning 
- Weighing 
- Identification 



Sugar





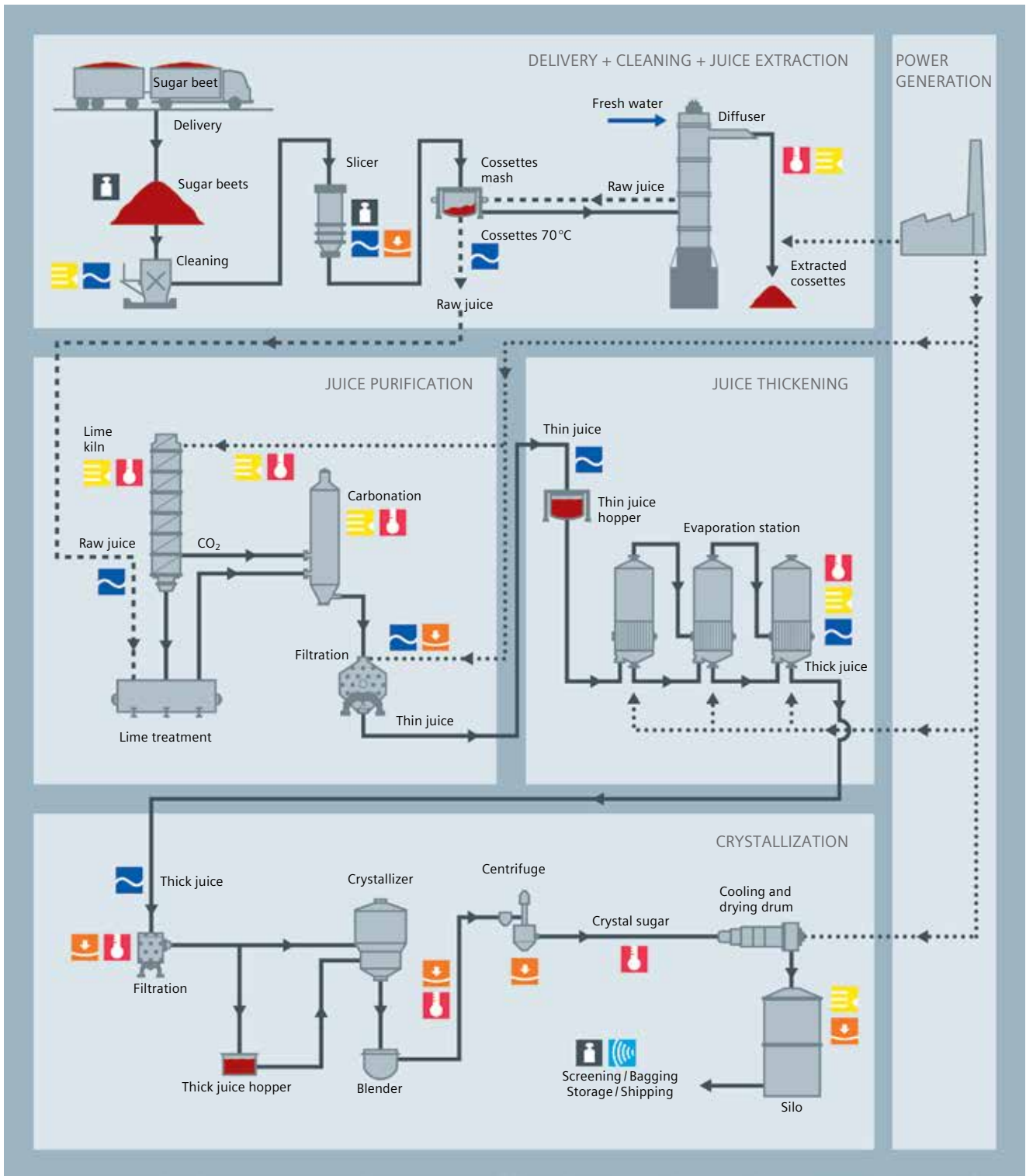

A wide range of competitive and manufacturing challenges face the sugar industry. Demand for sugar is steadily increasing but also shifting from domestic use to its application in terms of raw materials in processed food and beverages. This has increased the importance of supply chain logistics. Higher energy, water and utility costs have also added pressure to the cost base, intensifying the need for manufacturing efficiency.

Companies need to be able to manage high energy and utility demands. Buildings automation and manufacturing controls are becoming more important. Continuous 24/7 plant operation is critical for sugar plants with zero scheduled downtime. The size and colour of the microcrystal in

the sugar solution are vital qualitative factors. Successful sugar manufacturing demands a high level of automation and precise control over process parameters, saving time and increasing output.





Level  Flow  Pressure  Temperature  Identification  Weighing 

Dairy

The importance of dairy products in daily nutritional requirements means that continuous availability and high quality are paramount considerations for manufacturers. Hygiene is also critical, given that milk is an ideal culture in which micro-organisms can grow. Dairy production is subject to close government regulation and consumer scrutiny. Measurement and control of temperature and of fat and protein content are vitally important to the dairy manufacturing process.

Milk, cheese and fermented products, such as yogurt, all require precise production control parameters. The cultures used in cheese and fermented products make temperature control exceedingly important. Pure cultures must be produced very carefully according to hygienic principles. A poor or mismatched culture can lead to substantial product deficits. Tight control over storage times for cheese is essential. Cheese can last from several weeks to many months depending on temperature and humidity, both of which must be monitored precisely and adapted to each brand.

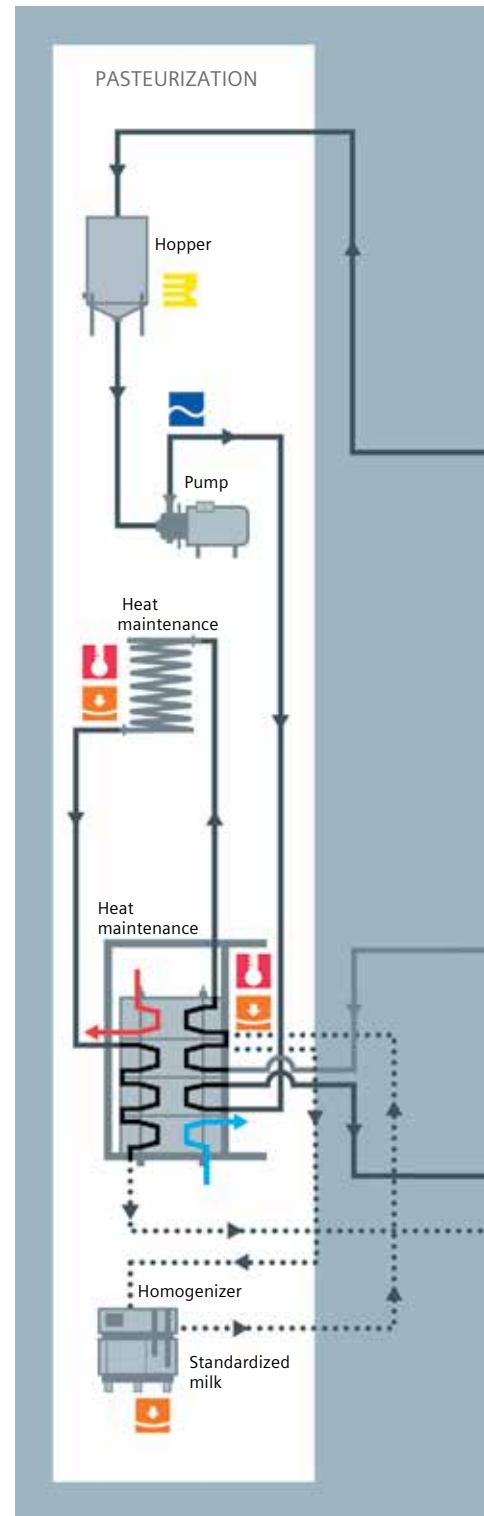

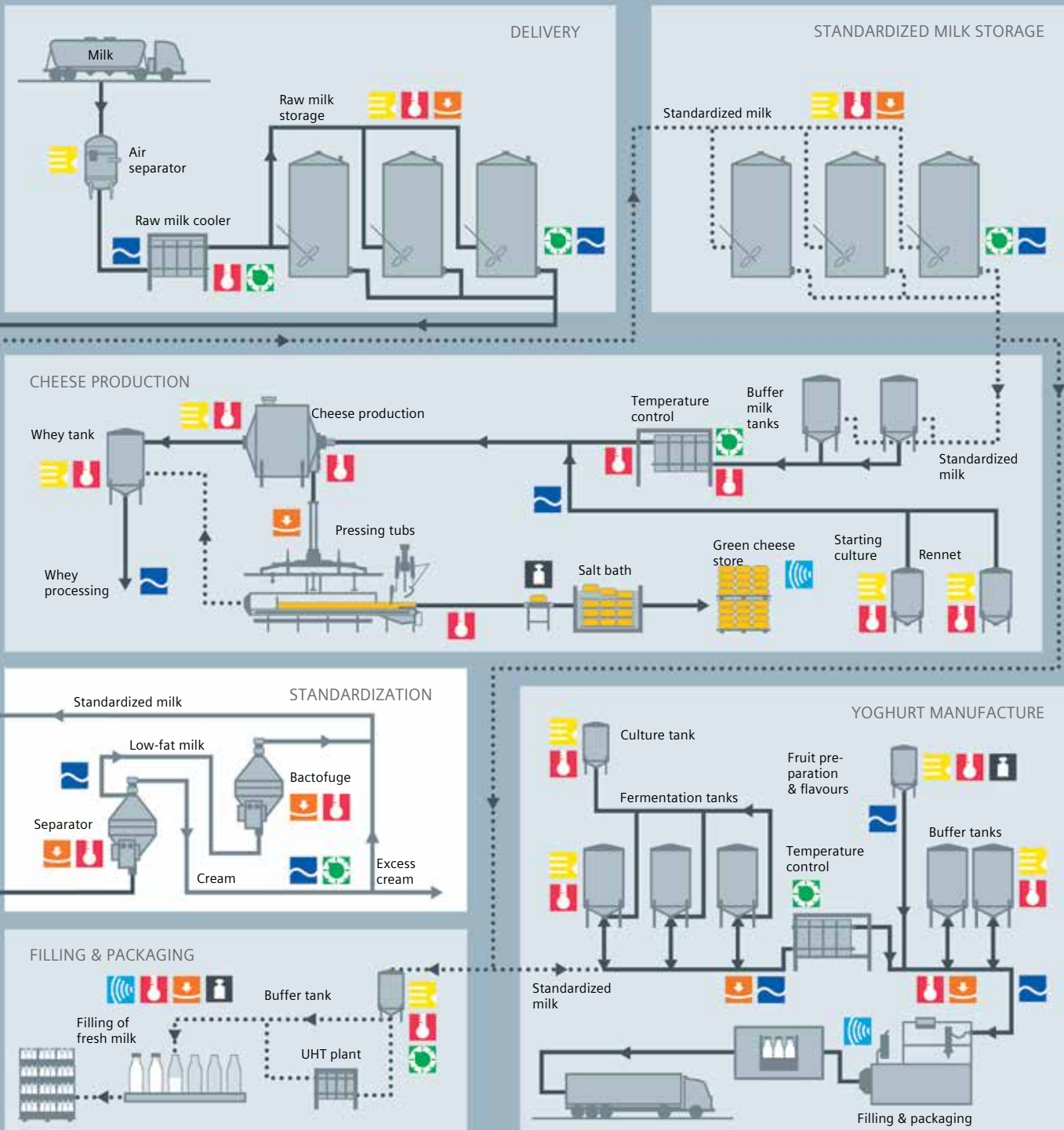

Pressure  Temperature  Valve positioning  Identification  Weighing 

Brewing

Brewers operate in intensely competitive product markets. Reputation, quality, customer loyalty and trust are everything. Price is king in key sectors of the marketplace. Companies operate in a highly dynamic customer-driven environment. In addition, seasonality heightens the importance of being able to utilize the brewery in a fast and flexible way but, always, with a focus on quality.

Whatever the marketplace, the ability to arrive at a finished, consistent beer quality is paramount. From milling and mashing, boiling and fermentation, filtration and conditioning, right through to the keg or the bottle, accurate measurement in terms of volume, weight, temperature

and turbidity is vital to the brewing process. Breweries also require access to an integrated view of the production and supply chain, enabling them to incorporate manufacturing controls and automation into their overall management systems.



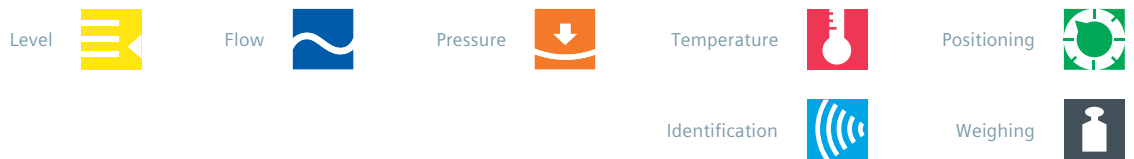
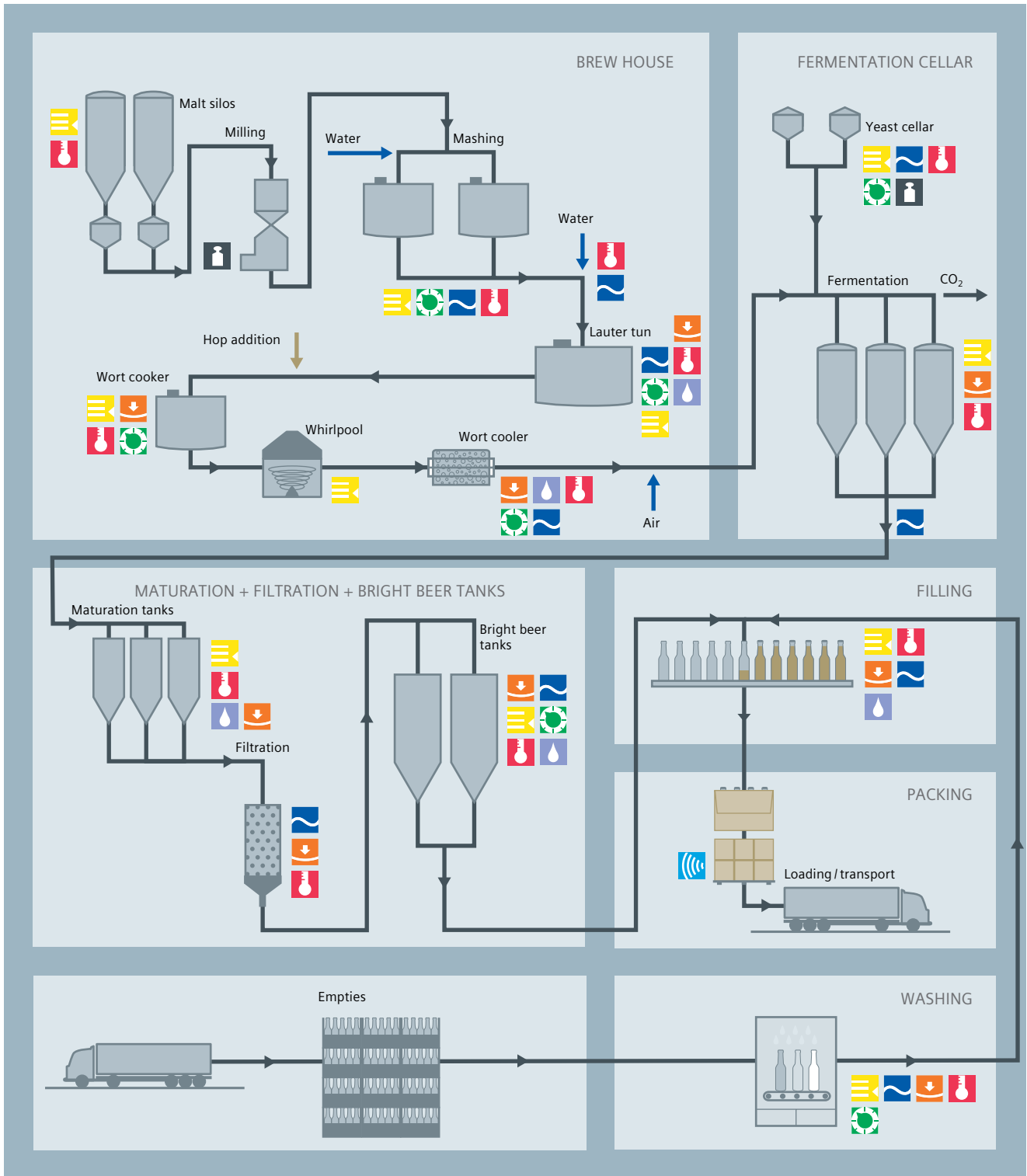

Soft drinks

Whether sports or energy beverages, the more traditional and well-established carbonated drinks or the new tea and coffee-based cold beverages, the soft drinks market is experiencing significant growth. Product innovation and diversification are key drivers in this expansion, putting more pressure on the use of production plants.

In common with other sectors of the food and beverage market, hygiene is critical. Most soft drinks are very susceptible to microbiological spoilage due to their high sugar content. Water quality must be consistent with the

need to prevent the interaction of elements in the water with flavorings. Accurate flow measurement and precise dosing of the ingredients are vital to a consistent and high-end quality product.



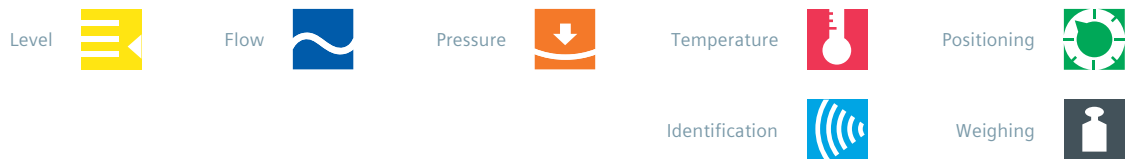
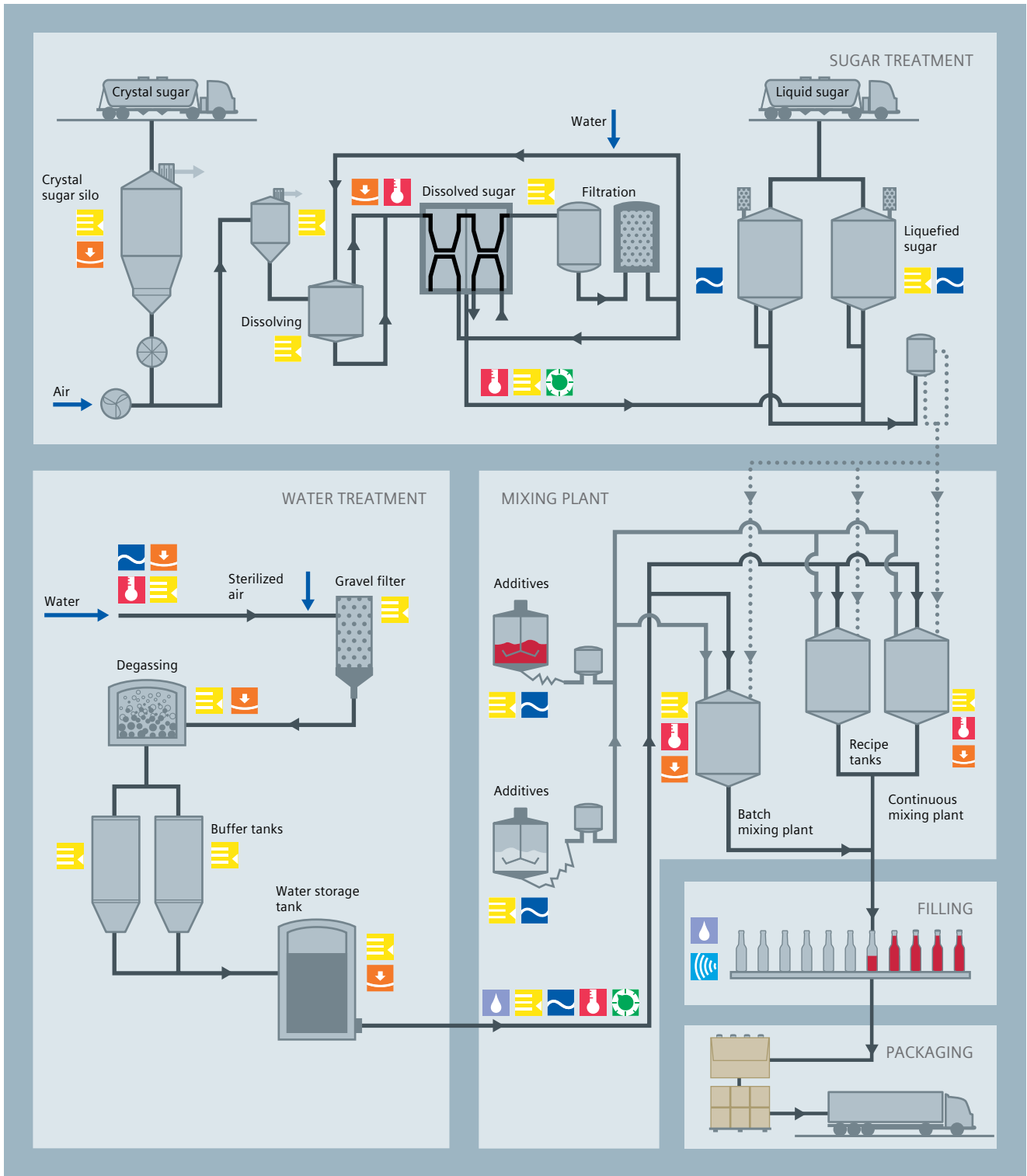

Flow

Storage, pumping, and dosing. All three activities lie at the heart of food and beverage production and require highly accurate flow measurement. Whether it is a strawberry ingredient added to yoghurt or the syrup, or carbon dioxide injected into water for a soft drink, flow measurement is vital to quality assurance and product consistency. It is also essential to ensure compliance with environmental regulations, food safety and, in the case of alcohol, fiscal regulatory requirements.



Sugar

The first stage of processing the raw sugar is to soften the cane by removing the unrefined liquor surrounding the crystals. The raw sugar is then mixed with warm and concentrated high-purity syrup to prevent the crystals from dissolving. To optimize the extraction of crystallized sugar, the flow of liquor needs to be accurately measured at various points in the process.

SITRANS FS230/FS220 clamp-on ultrasonic flow meter

- External transducers are mounted to the outside of the pipe, there is no contact with the medium
- Accuracy up to $\pm 0.5\%$ of flow rate
- Bidirectional flow rate measurement
- Sonic velocity measurement to assist in identifying the process fluid make up

Tomato Paste

When making tomato paste, raw tomatoes are first turned into pulp, which is then concentrated to a paste in an open steel vessel / steam kettle. Lastly, the preservatives are added and the paste is packed and stored. Flow meters are used to measure both the input to the kettle and the output of the thickened paste.

SITRANS FS230/FS220 clamp-on ultrasonic flow meter

- Minimal maintenance; external transducers do not require periodic cleaning
- No moving parts to foul or wear
- No pressure drop or energy loss

Dressing

Dressings may contain very salty and spicy ingredients with significant corrosive properties. As a non-sour product, dressings also provide an ideal culture medium for germs. Flow meters have direct contact with the product and it is therefore critical that coating and liner materials are resistant to corrosion and comply with the most stringent hygienic standards.

SITRANS F M MAG 1100 F

- Magnetic-inductive flow technology and flexible communication (HART®, PROFIBUS, MODBUS, DeviceNet, FOUNDATION Fieldbus)
- Ceramic (Al_2O_3) or PFA liners
- Maximum measuring error $\pm 0.2\% \pm 1 \text{ mm/s}$
- Degree of protection (enclosure) IP67 (IP68)
- Sanitary Approvals

Milk

Many dairy plants pour the treated milk in tin containers. These containers must be coated to prevent the milk from interacting with the container. Health and safety considerations govern how much coating is used. The SITRANS F C is able to measure and control the coating process so that the exact quantity and thickness is applied.

SITRANS FC400

- Digital input for dosing control, remote zero adjust or forced output mode
- High front-end resolution improves zero point stability and enhances dynamic turn-down on flow and density
- Fully stainless steel sensor enclosure
- 3A approved from 0.5 to 2.0 inches



Hygiene

Cleaning-In-Place (CIP) and Sanitization-In-Place (SIP) are central to milk processing. The flow meters must ensure that the cleaning agents are accurately dosed, the circulating velocity is correct and the system is completely empty. The process conditions – temperature, velocity and used cleaning agents – fluctuate quickly, making long-term stability and high measurement accuracy essential.

SITRANS F M MAG 1100 F

- Sanitary design for SIP/CIP cleaning
- Hygienic connections
- 3 A-approved and EHEDG-certified construction
- Stainless steel enclosure
- Dairy PMO approved

Soft drinks

The production of soft drinks revolves around mixing. Typically, four to five components are mixed. Measuring quantity on its own is not accurate enough. The measurement must also be performed inline. The process demands a momentary accuracy of 0.1 %.

SITRANS FC400

- Large dynamic turn-down ratio better than 500:1
- Densitometer performance typically better than 0.0005 g/cm^3 with repeatability better than 0.0001 g/cm^3
 - Brix, plato, and other concentrate measurements

Brewery

A field test of the SITRANS FC430 to quantify the concentration of sugar in unfermented beer was conducted with an international beverage manufacturer. Over the course of eight months, the meter demonstrated stability in fluctuating conditions and reliability in long-running scenarios. It also produced highly accurate readings in both stable and dynamic flow.

SITRANS FC400

- Among the market's most compact Coriolis solution
- Provides flow density and temperature readings accurately, reliably and with fast response times
- Complies with all major industry standards including 3 A
- Self-draining installation for optimum hygiene and food safety. Suitable for CIP/SIP cleaning
- High-speed 100 Hz signal processing means reliability even under dynamic conditions
- HART® and Profibus communication
- Multi-configurable I/O with up to 4 independent outputs

Pressure, temperature and valve positioning

Pressure measurement plays a vital role in food production plants. Besides measuring pressure for process-control purposes or for safety reasons, pressure-measuring instruments can be used to measure flow (orifice plate), level (hydrostatics) and differential pressure (filtration and heating processes) to determine parameters such as the extract content. Temperature is one of the most important parameters of all in the food-manufacturing process – both from a safety viewpoint and for process control and quality. Food safety methodologies, such as Hazard Analysis Critical Control Points (HACCP), highlight the importance not just of accurate temperature measurement but also its data capture. Valve positioners play an important role in the storage, pumping and mixing of liquids for food and beverage production. A valve positioner enables the precise control of a valve, providing the added benefit of a diagnostic capability.

Sugar

The extraction of sugar from cane or beet is a key stage in sugar production. The extraction is performed in two steps. First, the beet or cane is cut so that the sucrose can be removed in an extraction tower. Temperature control is critical. There is an optimal relationship between temperature and the energy needed to obtain the best yield of extracted sugar.

SITRANS T resistance thermometer

- Communication (4..20 mA, HART®, PROFIBUS, FOUNDATION Fieldbus) and maintenance functions enable optimization of the maintenance circle
- Hygienic design complies with FDA recommendations
- High-accuracy temperature measurement without disturbance of the process – clamp-on

Milk

Hygiene is a top priority in dairies. Measurement devices must satisfy high standards and be compatible with SIP and CIP processes.

SITRANS P300

- A pressure transmitter to suit the requirements of the food and beverage industry
- Offers an optimal relationship between price and performance
- Stainless steel housing and measuring cell is flush with the tank or pipe wall making it easy to clean and sterilize
- Suitable for process temperatures of up to 200 °C (392 °F)
- Available with the full range of hygienic connections





Brewery

In the fermentation process wort becomes beer, but substantial heat is produced with temperatures of up to 70°C (158°F). Before the beer is poured into bottles, cans or kegs it must be stabilized. Both stabilization and fermentation are achieved in a number of large tanks. Level measurement is important and the most common approach is hydrostatic measurement with an accuracy of up to 6 mm in 12 m (36 ft) tanks.

SITRANS P300

- A digital pressure transmitter offering 'three push button' handling and extensive diagnostics as well as simulation functions
- The stainless steel housing and measuring cell is designed according to hygienic requirements
- Suitable for CIP and SIP processes
- Broad range of communication (HART®, PROFIBUS, FOUNDATION Fieldbus) options
- Exact and stable measurements over a long period, e.g. the deviation in measured value is less than 0.075% with a long-term stability up to 0.125% over five years

Fermentation

Valves control the filling and draining of fermentation vessels in breweries. The fermentation process can last several days. The Siemens SIPART PS2 positioner provides precise valve monitoring and diagnosis of events even before problems arise.

SIPART PS2 valve positioner

- Compatible with both rotary and linear actuators, enabling standardization on one device, saving costs on training and spare parts
- Requires very little system energy, providing a rapid return on investment
- Considerable cost savings and control optimization thanks to air consumption, advanced diagnostics that pinpoint sediment in pipes and abrasion of valve seat/cones, and automated fast and easy commissioning



Weighing and dosing

Weighing, blending and dosing are of significant importance to the food and beverage industry. The filling process and the packaging of food products require highly accurate and automated systems to ensure compliance with the strict quality and hygiene regulations of a very competitive market.

Raw materials handling and blending

Maintaining accurate inventory is required to control costs. To track inventory accurately, grain is measured as it is put into storage silos. Often different varieties of wheat are blended to produce branded products. Whether tracking inventory or controlling a continuous blending process, continuous measurement of grain as it moves through the process improves quality and reduces process inefficiencies such as material costs and time loss. The SITRANS WF 300 with the Siemens SF500 solids flow meter measure grain as it is gravity fed through a pipe. If the grain is moved by conveyor, Siemens MSI belt scale with a Siemens BW500 belt scale provide accurate weight measurements without disruption to the process.

SITRANS WF300 series flowmeter

- High accuracy for monitoring a wide range of grain product ingredients and animal-feed blending
- Compact, reliable solution for applications with limited installation space
- Stainless steel option meets USDA and FDA requirements for food processing

Siemens MSI belt scale

- Outstanding accuracy and repeatability
- Unique parallelogram style load cell allows easy installation and reduced maintenance
- Direct suspension system allows fast reaction to varying loads





Malt dosing

The demands in a process such as malt dosing are immense, particularly where continuous dosage is the norm. For example, for 100 lb (45 kg) of malt at a daily capacity of 200 Tons (181 tons) and 450 batches per hour, metering precision needs to be less than 0.3 oz (10 g) and batch error below 0.6 oz (20 g).

SIWAREX weighing system

- Ideal for integration into automation solutions because no additional interfacing modules are required and the same engineering tools can be used
- The module response (e. g. diagnostic messages) is system-compatible
- An event recorder with time stamp records the course and status of weighing: a crucial tool for plant optimization
- Load cells and cables are permanently monitored for predictive maintenance to prevent downtime
- Snap-on methodologies make installation very easy
- Can be totally integrated into the SIMATIC control system, thus providing a complete automation solution



Level

The quality of food and beverage products relies on precise and accurate level measurements that ensure reliability in process controls, overflow prevention and protection against dry-running pumps. Such criteria are also used to balance and check stocks of raw materials, semi-finished products and finished goods. Inventory management must be implemented with the utmost precision to allow for the adequate demarcation and retracing of individual batches. The entire production planning process and supporting logistics depend upon ready availability of the correct stock.

Ice cream

Glucose is a central ingredient in ice cream production. It has a very high specific gravity and must be maintained at a temperature of 50 °C (122 °F) to ensure consistent flow. The supply of glucose must be ready to meet typical 16-hour and five-week plant production schedules. Effective storage and inventory control is therefore a priority. Ultrasonic technology provides for an ideal solution because it is non-invasive, and thus non-contaminating.

Echomax transducer with SITRANS LUT400 controller

- An ultrasonic level measurement system. The SITRANS LUT400 controller processes the signals from the Echomax sensor, providing a continuous readout of data relating to the tank level
- High-performance instrumentation provides continuous level measurement for virtually any short or medium range application up to 30 m (100 ft)
- Built-in Sonic Intelligence prevents interference from agitators and other obstructions commonly found in tanks
- Easy installation, set-up and operability



Grain silos

Beer is made from malt, water, hops and yeast. The key to efficiency and quality in beer production lies in the quality, purity and continuous availability of these raw materials. Malt is produced in malt houses, whence it is delivered to the breweries and stored in silos. Dust can accumulate once the barley or other grains are transferred to the silo. The problems this creates for level measurement can be compounded by the shape and design of the grain silo.

SITRANS radar technology

- SITRANS LR560 78 GHz radar transmitter allows for measurement through dust within enclosed silos
- An exceptionally narrow 4-degree beam angle can cope with complicated silo geometry
- Sealed lens cavity is highly resistant to dust build-up





Juice

Non-concentrate orange juice is growing in popularity, creating a need for worldwide shipping of fresh orange juice. This presents technical challenges. Ships are fitted with highgrade steel tanks. The juice must be kept at a defined low temperature and the tank must be germ-free and air-tight. This is achieved by vectoring nitrogen. Both the temperature and the nitrogen pressure must be measured precisely, monitored continuously and regulated.

SITRANS LR level transmitter

- SITRANS LR250's complete range of antennas and process connections makes this transmitter suitable for nearly any liquids application.
- Built to last, these antennas offer level flexibility for inventory and process vessels including hygienic applications.
- SITRANS LR100 series are 80 GHz compact radar transmitters with Bluetooth wireless technology. Featuring a narrow beam for flexible installations in existing vessel openings or non-intrusively through plastic vessels.



Food Grade Oils

When it comes to the production of spaghetti sauce or any number of other foodstuffs that contain edible oils such as olive oil, canola oil or sunflower oil, Siemens ultrasonics are top performers. Food oils have very low dielectric constants and can render radar and guided wave radar unreliable. Ultrasonic devices work on a change in density. Dielectric of the medium being measured has no effect on the ultrasonic measurement. Ultrasonics are perfect for outdoor storage tanks for monitoring just-in-time delivery. They are equally effective for the monitoring of indoor process vessels/hoppers or day tanks. If the application requires a simple-level measurement or complete control including relays and advanced communications to be integrated to a PLC, Siemens ultrasonics have you covered.

SITRANS ultrasonic level devices

- Use high frequency ultrasonic transducers for reliable measurement performance
- Supplied standard with Sonic Intelligence for top performance in all process conditions
- Built-in diagnostics
- Auto false-echo suppression
- Communications options using PROFIBUS, HART, AB RIO, and DeviceNet



Whiskey distilling

Quality ingredients and careful process monitoring are vital to the art and science of whiskey production. Prior to distillation, wort (a mix of barley and water) is cooled and pumped into pear-shaped fermenting vessels (wash stills). Operators then add yeast and the mixture produces wash (weak spirit). Foam is produced which can result in boiling high levels of froth mixing with the 'low wines' from the first stages of distillation. To control the foam, the burners must be turned off and restarted as the foam dissipates. It is desirable to automate the wash still operation to control the foam. However, because foam is neither liquid nor air, it is impossible to detect with traditional level measurement devices such as floats or vibrating forks.

Pointek CLS200

- Enables foam detection as well as automatic burner turn-off and restart
- Accurate, reliable and repeatable level detection
- Uses a unique inverse-frequency approach to capacitance technology, unlike traditional capacitance devices. Pointek switches monitor the effect of capacitance by frequency change rather than voltage drop or current flow
- The result is better accuracy and resolution because even small level changes create large shifts in frequency
- Contains a high-frequency oscillator with the sensor encapsulated in the probe tip. The probe is unaffected by the build-up of material, humidity or moisture

Product Purity

Many food and beverage products are created from highly bio-dynamic ingredients and processes. Quality and purity is essential. Irrespective of the type of ingredients used, food safety is a paramount consideration for food producers and Siemens alike.

SITRANS LR 250 HEA technology

- Tested and certified by the Institute of Food Process Engineering at the University of Karlsruhe
- The microwave emissions have been shown to have no general thermal or physical influences on liquid or dry solid foodstuffs
- A maximum transmitting power of 0.32 W / cm^2 ensures no effect on organisms in liquids such as beer and milk



Distributed Control Systems

Providing reliable operation, maintaining consistent product quality, and reducing plant costs are only a few of the many challenges that the food and beverage industry is facing today. Distributed control systems play an important role in helping you meet these challenges head-on. Siemens' flexible DCS offering enables you to respond quickly to constantly changing market requirements across the food and beverage industry, from sugar production to whiskey distilling. Equate demarcation and retracing of individual batches. The entire production planning process and supporting logistics depend upon ready availability of the correct stock.

SIMATIC PCS 7

SIMATIC is a state-of-the-art distributed control system (DCS) with more than 20 years of proven process control. Future proof and fit for digitalization, this reliable, safe, and rugged system supports flexible plant architectures, virtualized solutions, and other key features such as:

- Continuous, batch, and sequential control
- Integrated control and process safety
- Batch management
- Advanced process control
- Energy management solutions
- Integrated asset management
- Cyber security
- High performance graphics
- Alarm management

SIMATIC PCS neo

SIMATIC PCS neo is an innovative distributed control system (DCS) that offers companies in the process industry unique opportunities in the age of digitalization. Key features include global web-based collaboration in engineering and operations and a single, intuitive user interface for all automation tasks as well as:

- Browser based system access
- Zero installation clients
- Remote and mobile operation capabilities
- Object-oriented, single database
- Scalable plant architectures
- Multiuser engineering
- Late hardware binding
- Integrated Virtual Controller
- Built-in cyber security
- Centralized software administration and user management



Hardware

S7-410 Controller

The S7-410 Controller is the fastest and most powerful controller on the market - offering flexible, high availability performance for process automation. It covers all applications, application scopes, and performance ranges with a single hardware and firmware platform.

SIMATIC ET 200SP HA

SIMATIC ET 200SP HA is the most powerful and compact distributed I/O for the process industries. It is ready for use inside and outside the control cabinet and can be expanded in small steps: modules for digital and analog inputs/outputs, safety technology, motor starts, and more. Frequency inverters and other technology components ensure that you can equip your I/O system with the appropriate signal and functional modules.

SIMATIC Compact Field Unit

The SIMATIC Compact Field Unit (CFU) combines the digital fieldbus with traditional I/Os and is suitable for use directly in the field. This unit significantly reduces the footprint of the entire I/O system by offering new perspectives on simplicity and flexibility. The device also reduces error potential during operation, simplifies plant expansions and modernization, and reduces the cost of hardware FAT.

Totally Integrated Automation

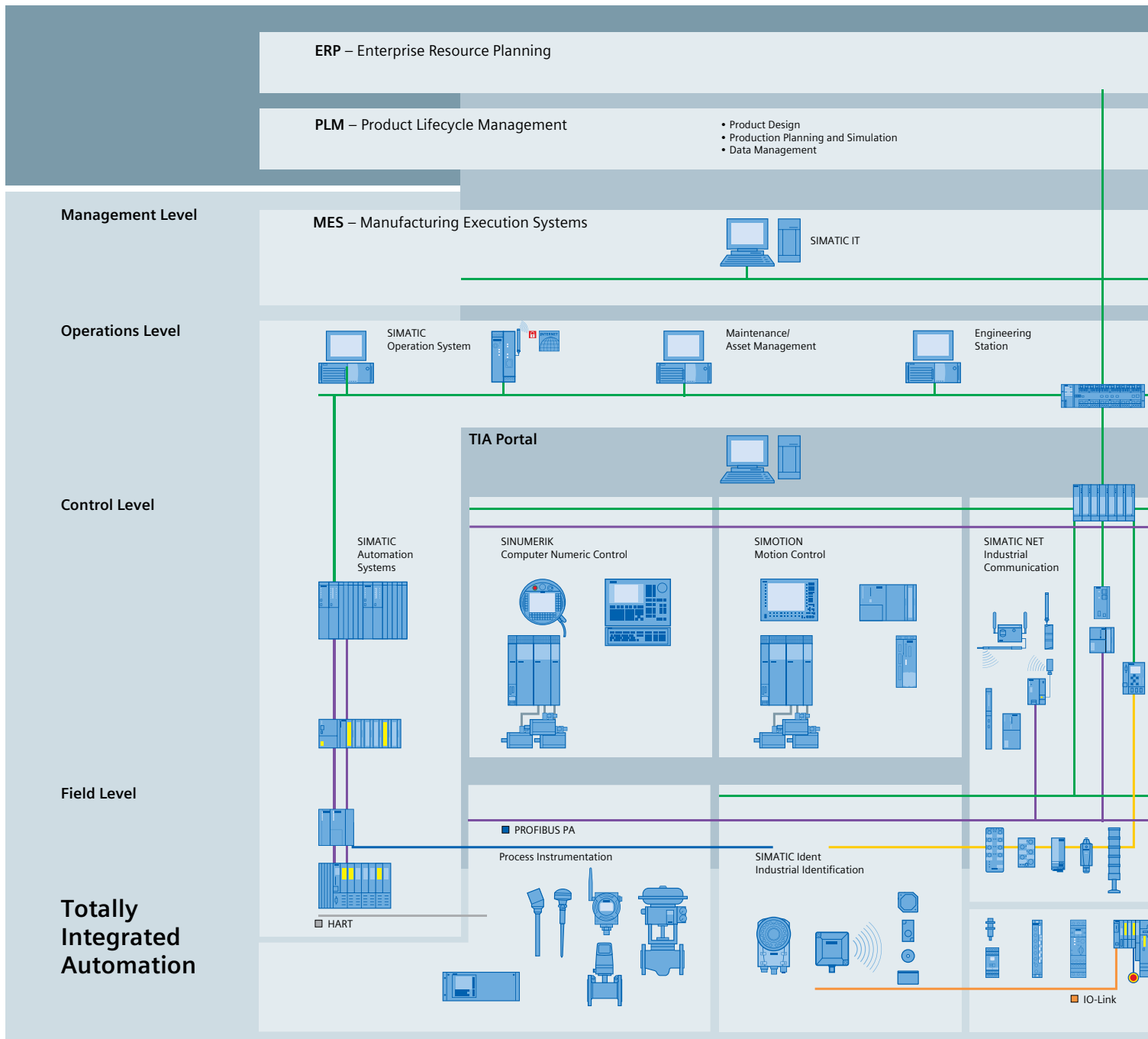

Products from the controller level to the field level

With Totally Integrated Automation (TIA), Siemens is the only provider of an end-to-end integrated portfolio of products and systems for the automation of the entire production workflow. From the goods receiving area to the finished goods warehouse.

Totally Integrated Automation reduces the complexity of the automation solution and enables what really counts: the practical combination of optimally coordinated individual components – without interface problems.

Totally Integrated Automation integrates not only the production process but all parts of the company – from the field level to the management level. The result: a perfectly coordinated overall concept that enables higher productivity.

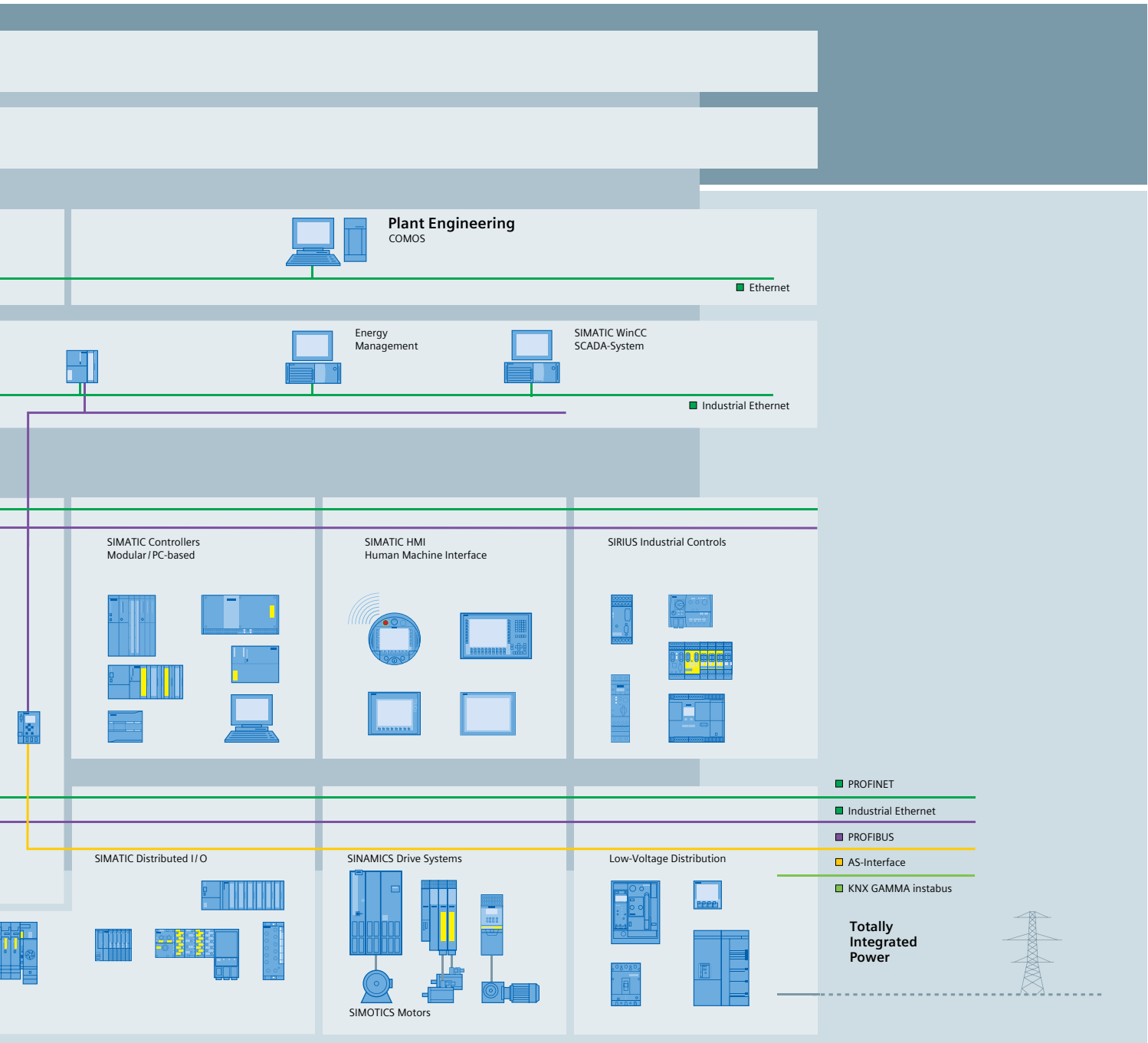

Example: SIMATIC PCS 7. The innovative process control system offers numerous options for connecting I/Os as well as for sending and receiving process signals via sensors and actuators.

Industrial Identification

Identification systems assist companies in leveraging their positions in ever more dynamic markets: Automatic data acquisition via Radio Frequency Identification (RFID) or Optical Industrial Identification (OID) will help you meet the continuously growing demands made on production control and material flows, asset management, tracking & tracing as well as supply chain management. Siemens provides the key technologies for these purposes. As the global market leader for industrial identification systems with more than 25 years of experience and industry expertise, Siemens offers a comprehensive range of RFID and OID systems.

Radio Frequency Identification and Code Reading Systems

The right solution for every identification job from just-in-sequence production to safe and complete traceability of products or batches; Data Matrix Codes (DMC) or RFID convince through high level of data security and have proven themselves in many applications – even in rough industrial environments. They offer a serious reduction in time and effort when compared to manual identification and acquisition techniques.

SIMATIC Ident: industrial identification from a single source

- Broad range of identification systems (RFID, 1D/2D code reading systems, OCR), interface modules and software
- Fully automatic, reliable and high-speed identification
- Components with a high degree of protection for industrial use, insensitive to temperature fluctuations and contamination
- Variety of tags
- Flexible communication with the automation system: serial, via PROFIBUS, PROFINET or Ethernet
- Seamless integration into higher-level IT systems

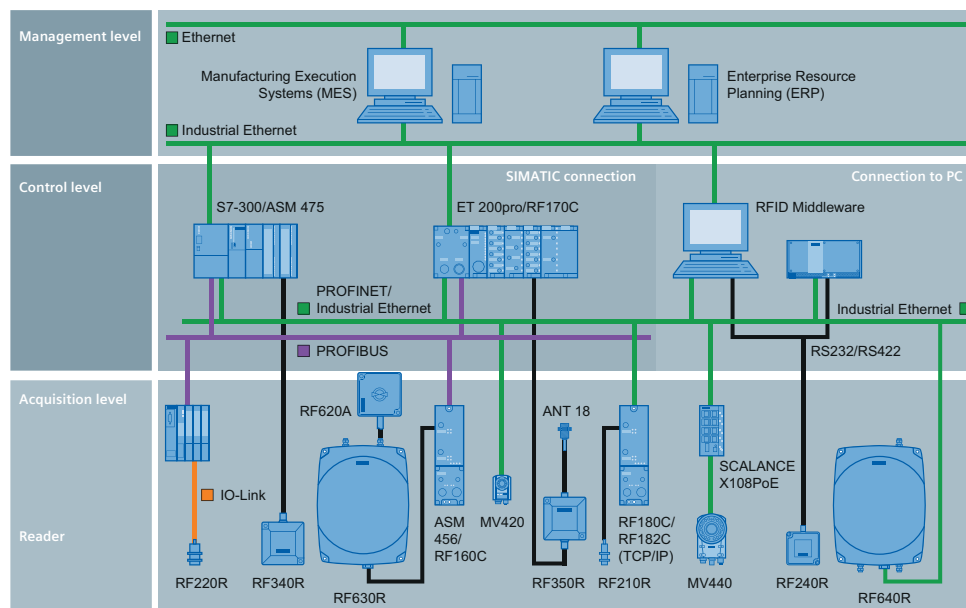

Services and support

Siemens offers field-proven concepts for process instrumentation from a single source, providing you with development continuity and a high level of security.



Our services range from consulting and engineering, connection to the control system and comprehensive after-sales services:

- System and schedule planning
- Complete design planning and engineering of the field devices
- Consultation on the selection of process instruments
- System documentation
- Installation, testing and commissioning
- Comprehensive after-sales service

Service around the world

Plants must function reliably around the clock. Efficient and effective process instrumentation are an indispensable prerequisite to this end. You also need to be certain of fast and competent service from your supplier. Siemens is a global company that reacts locally. Whether you require consulting, quick delivery or installation of new devices, the Siemens network of specialists is available to you around the world, whatever your location.

Service around the clock

Our online support system offers rapid, comprehensive assistance regardless of time or location. From product support to service information, the online support of Siemens Industry Automation and Drive Technologies is your first choice – around the clock, 365 days a year.

www.siemens.com/automation/service&support

Process Automation and Instrumentation product range

Siemens offers the most comprehensive product range for the food & beverage industry and has a solution for even the most difficult measurements.

Continuous level measurement

Radar



Liquids level measurement

SITRANS LR250's complete range of antennas and process connections makes this transmitter suitable for nearly any liquids application. Built to last, these antennas offer level flexibility for inventory and process vessels including hygienic applications. SITRANS LR100 series are 80 GHz compact radar transmitters with Bluetooth wireless technology. Featuring a narrow beam for flexible installations in existing vessel openings – or non-intrusively through plastic vessels.

Solids level measurement

SITRANS LR560 offer continuous monitoring of solids for a variety of silos or storage bins to a range 328 feet.

Guided wave radar

2-wire, guided wave radar transmitter for short- to medium-range level, level / interface, and volume measurement of liquids and solids and offers configuration options for your hygienic application requirements.

Flow measurement



Electromagnetic flowmeters







Siemens full series of flowmeters for liquids and slurries gives a wide range of customer-specified process connections.

Coriolis flowmeters

One of the most accurate flow measurement technologies, measuring true mass flow unaffected by variations in pressure, temperature, density, electrical conductivity and viscosity. It is a multi-variable device delivering reliable information on mass flow, volume flow, temperature, density and concentration (e.g. Brix or Baume). SITRANS FC430 is the market's most compact Coriolis solution. The small size facilitates installation and replacement, and makes it possible to fit multiple units into tight spaces.

Clamp-on ultrasonic flowmeters

The key feature of the clamp-on ultrasonic flow technology is the externally-mounted sensor. They are quickly and easily installed on the outside of the pipe. The technology provides highly accurate measurement on pipes with different sizes, making them suitable for a wide range of applications.

			☰ Point level
Ultrasonic			
			
Ultrasonic level transmitters	Level controllers and transducers	Point level switches	
SITRANS Probe LU240 ultrasonic level transmitter is a two wire, loop powered, cost-effective, compact, intelligent level solution for liquid inventory in all industries	SITRANS LUT400 can be used in a variety of applications in combination with Echomax transducers.	SITRANS LPS200, SITRANS LVS200, Pointek CLS200, SITRANS LVL200 and Pointek ULS200 offer a range of level detection options for liquids and solids applications.	
☑ Pressure	🔥 Temperature	🔄 Positioning	
			
Pressure measurement	Temperature Measurement	Valve Positioners	
SITRANS P offers a complete range of instruments for measuring relative, differential and absolute pressure. The SITRANS P300 has a hygienic stainless steel housing with laser-etched nameplate. The SITRANS P300 meets the requirements of EHEDG, FDA and 3 A. Cleaning and sterilization are standard practice.	The clamp-on thermometer offers quick and highly accurate measurement without disturbance of the process and provides easy recalibration. Equipped with our unique SITRANS TH or TR transmitters, we offer the turnkey solution. Classical wetted temperature sensors complete the temperature measurement portfolio.	Positioner for linear and rotary actuators. Particularly flexible stroke range, intelligent diagnostics and communication either via HART, PROFIBUS PA or Foundation Fieldbus	

 Weighing

		
<p>SITRANS solids flowmeters</p>	<p>Milltronics belt scales</p>	<p>SITRANS weighfeeders</p>
<p>Accurate measurement and control of flow rates of product so that quality and plant efficiency are consistently maintained. Dust-tight, ensuring a healthier work environment, especially during hazardous substance monitoring.</p>	<p>Heavy-duty, High-accuracy single idler belt scales used for process and load-out control. Milltronics belt scales provide continuous inline weighing for monitoring such products as flour, grain or sugar.</p>	<p>Control and monitor feed rates and blending in cereals, seeds or minerals; easy belt removal for replacement or cleaning, fast installation, easy to clean and maintain.</p>

 Process protection

		
<p>Speed sensors</p>	<p>Zero speed switch</p>	<p>Motion failure alarm</p>
<p>Speed sensors operate in conjunction with a conveyor or belt scale, providing a signal to an integrator (Milltronics BW500, BW500L SIWAREX WT241, or SIWAREX WP241 module), which computes the rate of material being conveyed.</p>	<p>SITRANS WM100 is a heavy-duty zero-speed alarm switch. This non-contacting unit provides cost-effective equipment protection even in the harshest conditions. This rugged unit is impervious to dust, dirt, buildup, and moisture and is ideal for monitoring bucket elevators, screw conveyors, and rotating shafts.</p>	<p>Siemens motion failure alarms detect changes in the motion and speed of rotating, reciprocating, or conveying equipment. It warns of equipment malfunction and signals to shut down machinery in case of a slowdown or failure.</p>



SIWAREX load cells

A wide selection of different designs: from platform load cells to bending and shear beam, s-type, and compression cells. The SIWAREX WL260 load cell series cover nominal loads from 0.3kg to 500t. Siemens load cell portfolio is completed with mounting units to simplify installation and allow optimum alignment of the load cell and protect the load cell against overloads or transverse loads.



Standalone weighing electronics

Milltronics BW500, BW500L SIWAREX WT241, or SIWAREX WP241 module integrators work with single or dual strain gauge load cell-based belt scales. Milltronics SF500 operates with any solids flowmeter with up to two strain-gauge load cells or LVDT sensor.



Weighing modules for direct integration

SIWAREX weighing electronics provide a comprehensive range of weighing electronics. With modules available for hopper scales, platform scales, batching systems, filling machines, belt scales, solids flowmeters, and loss-in-weight feeders. These weighing modules seamlessly integrate into Step 7, TIA Portal and PCS7.

Engineered Instrument Solutions (EIS)

Remote monitoring and displays



Acoustic monitoring

SITRANS AS100 detects changes in high-frequency sound waves resulting from particle impacts on equipment. In combination with SITRANS CU02 alarm control unit, it detects and reacts instantly to changes in solids flow. The AS100 and CU02 can provide non evasive monitoring of solid materials flowing through a pipe to detect plugged chutes and route verification.



Engineered Instrument Solutions (EIS)

Siemens engineering expertise combined with an expansive portfolio of products and services enables us to design comprehensive, customized and cost effective solutions for the process industries.



Remote Displays 100/150 / 200 / 500

SITRANS RD100 / 200 are remote displays for process instrumentation. The SITRANS RD150 is a remote-digital display for 4 to 20 mA and HART devices. SITRANS RD500 provides integrated web access, alarm event handling, and data capture.

Measuring everything that matters:

usa.siemens.com/pi

Siemens Process Instrumentation offers best-in-class measurement and seamless integration into your automation system. We are the total solution provider for flow, level, pressure, temperature, weighing, positioners and more.

Legal Manufacturer

Siemens Industry, Inc.
100 Technology Drive
Alpharetta, GA 30005
United States of America
Telephone: +1 (800) 365-8766
usa.siemens.com/pi
Order No. PIBR-00021-0322

This document contains a general description of available technical options only, and its effectiveness will be subject to specific variables including field conditions and project parameters. Siemens does not make representations, warranties, or assurances as to the accuracy or completeness of the content contained herein. Siemens reserves the right to modify the technology and product specifications in its sole discretion without advance notice.