

SIEMENS

SIMATIC

Products for Totally Integrated Automation

Catalog
News
ST 70 N

Edition
2020

[siemens.com/tia](https://www.siemens.com/tia)

Related catalogs

SIMATIC ST 70
 Products for
 Totally Integrated Automation

PDF (E86060-K4670-A101-B7-7600)



Motion Control System PM 21
 SIMOTION
 Equipment for Production Machines

E86060-K4921-A101-A4-7600



SIMATIC HMI / PC-based Automation ST 80/ST PC
 Human Machine Interface Systems
 PC-based Automation

PDF (E86060-K4680-A101-C7-7600)



SITRAIN
 Digital Industry Academy

www.siemens.com/sitrain



Industrial Communication IK PI
 SIMATIC NET

E86060-K6710-A101-B8-7600



Siemens TIA Selection Tool
 for the selection, configuration and ordering of
 TIA products and devices

www.siemens.com/tst



SIMATIC ST PCS 7
 SIMATIC PCS 7 Process Control System
 Vol. 1: System components

E86060-K4678-A111-C6-7600



Industry Mall
 Information and Ordering Platform
 on the Internet:

www.siemens.com/industrymall



SIMATIC ST 400
 SIMATIC S7-400 advanced controller

PDF (E86060-K4678-A151-A1-7600)



Contact
 Your personal contact can be found in our
 Contacts Database at:

www.siemens.com/automation-contact



SITOP KT 10.1
 SITOP
 Power supply

E86060-D4001-A510-D8



TIA Selection Tool

The smart configurator for the entire Siemens automation portfolio



Prime reasons for the TIA Selection Tool



Quick, easy and secure

Components can be selected, configured and ordered quickly, easily and securely from the Siemens automation portfolio



Intelligent

Intelligent selection wizards check the compatibility of the configured components and enable error-free ordering



Clear

Required modules, devices and networks are automatically generated and clearly compared to one another



Time-saving

Time savings of 80% in design – thanks to ease of use and intelligent support

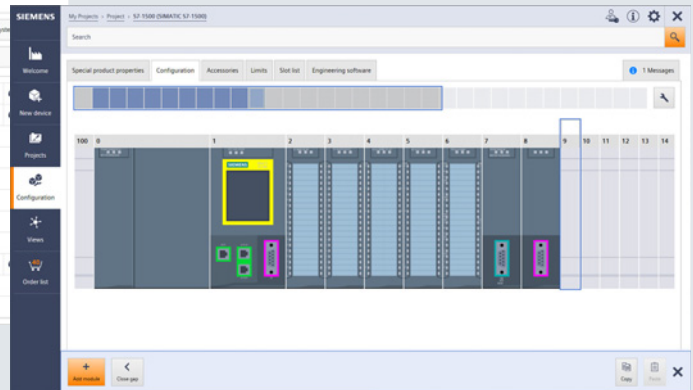
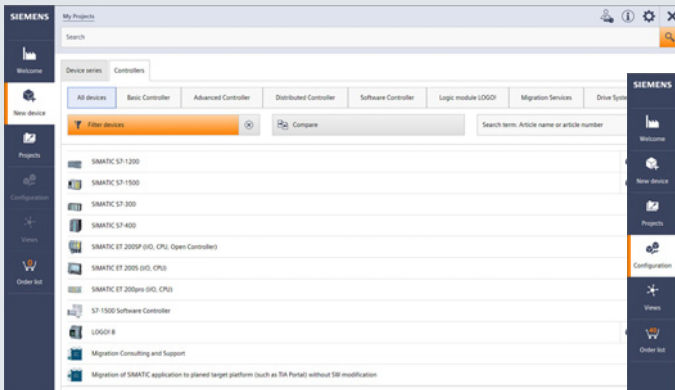

The TIA Selection Tool is a completely paperless solution.

Download it now:

www.siemens.com/tst

For more information, scan the QR code



Products for Totally Integrated Automation

SIMATIC



Catalog News ST 70 N · 2020

Refer to the Industry Mall for current updates of this catalog:

www.siemens.com/industrymall

© Siemens 2020

Introduction	1
LOGO! logic module	2
SIMATIC S7-1200 Basic Controllers	3
SIMATIC S7-1500 Advanced Controllers	4
SIMATIC S7-300 Advanced Controllers	5
SIMATIC S7-400 Advanced Controllers	6
Distributed Controllers	7
Software Controllers	8
Drive Controllers	9
I/O systems	10
SIMATIC control systems	11
Software for SIMATIC Controllers	12
SIMATIC programming devices	13
Products for specific requirements	14
Overviews	15
Supplementary components	16
Appendix	17



The products and systems described in this catalog are manufactured/distributed under application of a certified quality management system in accordance with DIN EN ISO 9001 (Certified Registration No. 001323QM-15). The certificate is recognized by all IQNet countries.

Digital Enterprise

The building blocks that ensure everything works together perfectly in the digital enterprise

Digitalization is already changing all areas of life and existing business models. It is placing greater pressure on industry while at the same time creating new business opportunities. Today, thanks to scalable solutions from Siemens, companies can already become a digital enterprise and ensure their competitiveness.



Industry faces tremendous challenges



Reduce time-to-market

Today manufacturers have to bring products to market at an ever-increasing pace despite the growing complexity of these products. In the past, a major manufacturer would push aside a small one, but now it is a fast manufacturer that overtakes a slow one.



Boost flexibility

Consumers want customized products, but at a price they would pay for a mass-produced item. That only works if production is more flexible than ever before.



Improve quality

To ensure a high level of quality while meeting legal requirements, companies have to establish closed quality loops and enable the traceability of products.



Boost efficiency

Today the product itself needs to be sustainable and environmentally friendly, while energy efficiency in production has become a competitive advantage.



Increase security

Increasing networking escalates the threat to production facilities of cyberattacks. Today more than ever, companies need suitable security measures.



The digital enterprise has already become a reality

To fully benefit from all the advantages of digitalization, companies first have to achieve complete consistency of their data. Fully digitally integrated business processes, including those of suppliers, can help to create a digital representation of the entire value chain. This requires

- the integration of industrial software and automation,
- expansion of the communication networks,
- security in automation,
- and the use of business-specific industrial services.

MindSphere

The cloud-based open IoT operating system from Siemens

With MindSphere, Siemens offers a cost-effective and scalable cloud platform as a service (PaaS) for the development of applications. The platform, designed as an open operating system for the Internet of Things, makes it possible to improve the efficiency of plants by collecting and analyzing large volumes of production data.

Totally Integrated Automation (TIA) Where digitalization becomes reality

Totally Integrated Automation (TIA) ensures the seamless transition from the virtual to the real world. It already encompasses all the necessary conditions for transforming the benefits of digitalization into true added value. The data that will form the digital twin for actual production is generated from a common base.

Digital Plant

Learn more about the digital enterprise for the process industry
www.siemens.com/digitalplant

Digital Enterprise Suite

Learn more about the digital enterprise for the discrete industry
www.siemens.com/digital-enterprise-suite

LOGO! logic module



2/2
2/2

LOGO! basic and expansion modules
SIPLUS LOGO! modular expansion modules

LOGO! logic module

LOGO! basic and expansion modules

SIPLUS LOGO! modular expansion modules

Overview

2



- Expansion modules for connection to LOGO! modular
- With digital inputs and outputs, analog inputs, or analog outputs

Note:

SIPLUS LOGO! 6 versions are not compatible with SIPLUS LOGO! 8.

SIPLUS extreme products are based on SIMATIC standard products. The contents listed here were adopted from the respective standard products. SIPLUS extreme specific information was added.

Technical specifications

Article number	6AG1055-1CB00-7BA2	6AG1055-1HB00-7BA2	6AG1055-1MB00-7BA2
Based on	6ED1055-1CB00-0BA2 SIPLUS LOGO! DM8 24 V8	6ED1055-1HB00-0BA2 SIPLUS LOGO! DM8 24R V8	6ED1055-1MB00-0BA2 SIPLUS LOGO! DM8 12/24R V8
Ambient conditions			
Ambient temperature during operation			
• min.	-40 °C; = Tmin; Startup @ -25 °C	-40 °C; = Tmin; Startup @ -25 °C	-40 °C; = Tmin; Startup @ -25 °C
• max.	70 °C; Tmax; Tmax > +55 °C max. load 0.2 A per output	70 °C; = Tmax; Tmax > +55 °C max. load 3 A per relay or max. total current 10 A	70 °C; = Tmax; Tmax > +55 °C max. load 3 A per relay or max. total current 10 A
• At cold restart, min.	-25 °C; incl. condensation / frost permitted (no commissioning under condensation conditions)	-25 °C; incl. condensation / frost permitted (no commissioning under condensation conditions)	-25 °C; incl. condensation / frost permitted (no commissioning under condensation conditions)
Altitude during operation relating to sea level			
• Installation altitude above sea level, max.	5 000 m	5 000 m	5 000 m
• Ambient air temperature-barometric pressure-altitude	Tmin ... Tmax at 1 140 hPa ... 795 hPa (-1 000 m ... +2 000 m) // Tmin ... (Tmax - 10 K) at 795 hPa ... 658 hPa (+2 000 m ... +3 500 m) // Tmin ... (Tmax -20 K) at 658 hPa ... 540 hPa (+3 500 m ... +5 000 m)	Tmin ... Tmax at 1 140 hPa ... 795 hPa (-1 000 m ... +2 000 m) // Tmin ... (Tmax - 10 K) at 795 hPa ... 658 hPa (+2 000 m ... +3 500 m) // Tmin ... (Tmax -20 K) at 658 hPa ... 540 hPa (+3 500 m ... +5 000 m)	Tmin ... Tmax at 1 140 hPa ... 795 hPa (-1 000 m ... +2 000 m) // Tmin ... (Tmax - 10 K) at 795 hPa ... 658 hPa (+2 000 m ... +3 500 m) // Tmin ... (Tmax -20 K) at 658 hPa ... 540 hPa (+3 500 m ... +5 000 m)
Relative humidity			
• With condensation, tested in accordance with IEC 60068-2-38, max.	100 %; RH incl. condensation / frost (no commissioning in bedewed state), horizontal installation	100 %; RH incl. condensation / frost (no commissioning in bedewed state), horizontal installation	100 %; RH incl. condensation / frost (no commissioning in bedewed state), horizontal installation
Resistance			
Coolants and lubricants			
- Resistant to commercially available coolants and lubricants	Yes; Incl. diesel and oil droplets in the air	Yes; Incl. diesel and oil droplets in the air	Yes; Incl. diesel and oil droplets in the air
Use in stationary industrial systems			
- to biologically active substances according to EN 60721-3-3	Yes; Class 3B2 mold, fungus and dry rot spores (with the exception of fauna); Class 3B3 on request	Yes; Class 3B2 mold, fungus and dry rot spores (with the exception of fauna); Class 3B3 on request	Yes; Class 3B2 mold, fungus and dry rot spores (with the exception of fauna); Class 3B3 on request
- to chemically active substances according to EN 60721-3-3	Yes; Class 3C4 (RH < 75 %) incl. salt spray acc. to EN 60068-2-52 (severity degree 3); *	Yes; Class 3C4 (RH < 75 %) incl. salt spray acc. to EN 60068-2-52 (severity degree 3); *	Yes; Class 3C4 (RH < 75 %) incl. salt spray acc. to EN 60068-2-52 (severity degree 3); *
- to mechanically active substances according to EN 60721-3-3	Yes; Class 3S4 incl. sand, dust, *	Yes; Class 3S4 incl. sand, dust, *	Yes; Class 3S4 incl. sand, dust, *

Technical specifications

Article number	6AG1055-1CB00-7BA2	6AG1055-1HB00-7BA2	6AG1055-1MB00-7BA2
Based on	6ED1055-1CB00-0BA2 SIPLUS LOGO! DM8 24 V8	6ED1055-1HB00-0BA2 SIPLUS LOGO! DM8 24R V8	6ED1055-1MB00-0BA2 SIPLUS LOGO! DM8 12/24R V8
Use on ships/at sea			
- to biologically active substances according to EN 60721-3-6	Yes; Class 6B2 mold and fungal spores (excluding fauna); Class 6B3 on request	Yes; Class 6B2 mold and fungal spores (excluding fauna); Class 6B3 on request	Yes; Class 6B2 mold and fungal spores (excluding fauna); Class 6B3 on request
- to chemically active substances according to EN 60721-3-6	Yes; Class 6C3 (RH < 75 %) incl. salt spray acc. to EN 60068-2-52 (severity degree 3); *	Yes; Class 6C3 (RH < 75 %) incl. salt spray acc. to EN 60068-2-52 (severity degree 3); *	Yes; Class 6C3 (RH < 75 %) incl. salt spray acc. to EN 60068-2-52 (severity degree 3); *
- to mechanically active substances according to EN 60721-3-6	Yes; Class 6S3 incl. sand, dust; *	Yes; Class 6S3 incl. sand, dust; *	Yes; Class 6S3 incl. sand, dust; *
Usage in industrial process technology			
- Against chemically active substances acc. to EN 60654-4	Yes; Class 3 (excluding trichlorethylene)	Yes; Class 3 (excluding trichlorethylene)	Yes; Class 3 (excluding trichlorethylene)
- Environmental conditions for process, measuring and control systems acc. to ANSI/ISA-71.04	Yes; Level GX group A/B (excluding trichlorethylene; harmful gas concentrations up to the limits of EN 60721-3-3 class 3C4 permissible); level LC3 (salt spray) and level LB3 (oil)	Yes; Level GX group A/B (excluding trichlorethylene; harmful gas concentrations up to the limits of EN 60721-3-3 class 3C4 permissible); level LC3 (salt spray) and level LB3 (oil)	Yes; Level GX group A/B (excluding trichlorethylene; harmful gas concentrations up to the limits of EN 60721-3-3 class 3C4 permissible); level LC3 (salt spray) and level LB3 (oil)
Remark			
- Note regarding classification of environmental conditions acc. to EN 60721, EN 60654-4 and ANSI/ISA-71.04	* The supplied plug covers must remain in place over the unused interfaces during operation!	* The supplied plug covers must remain in place over the unused interfaces during operation!	* The supplied plug covers must remain in place over the unused interfaces during operation!
Conformal coating			
• Coatings for printed circuit board assemblies acc. to EN 61086	Yes; Class 2 for high availability	Yes; Class 2 for high availability	Yes; Class 2 for high availability
• Protection against fouling acc. to EN 60664-3	Yes; Type 1 protection	Yes; Type 1 protection	Yes; Type 1 protection
• Military testing according to MIL-I-46058C, Amendment 7	Yes; Discoloration of coating possible during service life	Yes; Discoloration of coating possible during service life	Yes; Discoloration of coating possible during service life
• Qualification and Performance of Electrical Insulating Compound for Printed Board Assemblies according to IPC-CC-830A	Yes; Conformal coating, Class A	Yes; Conformal coating, Class A	Yes; Conformal coating, Class A
Article number	6AG1055-1FB00-7BA2	6AG1055-1NB10-7BA2	
Based on	6ED1055-1FB00-0BA2 SIPLUS LOGO! DM8 230R V8	6ED1055-1NB10-0BA2 SIPLUS LOGO! DM16 24R V8	
Ambient conditions			
Ambient temperature during operation			
• min.	-40 °C; = Tmin; Startup @ -25 °C	-40 °C; = Tmin; Startup @ -25 °C	
• max.	70 °C; = Tmax; Tmax > +55 °C max. load 3 A per relay or max. total current 10 A	70 °C; = Tmax; Tmax > +55 °C max. load 3 A per relay	
• At cold restart, min.	-25 °C; incl. condensation / frost permitted (no commissioning under condensation conditions)	-25 °C; incl. condensation / frost permitted (no commissioning under condensation conditions)	
Altitude during operation relating to sea level			
• Installation altitude above sea level, max.	2 000 m	5 000 m	
• Ambient air temperature-barometric pressure-altitude	Tmin ... Tmax at 1 140 hPa ... 795 hPa (-1 000 m ... +2 000 m)	Tmin ... Tmax at 1 140 hPa ... 795 hPa (-1 000 m ... +2 000 m) // Tmin ... (Tmax - 10 K) at 795 hPa ... 658 hPa (+2 000 m ... +3 500 m) // Tmin ... (Tmax -20 K) at 658 hPa ... 540 hPa (+3 500 m ... +5 000 m)	
Relative humidity			
• With condensation, tested in accordance with IEC 60068-2-38, max.	100 %; RH incl. condensation / frost (no commissioning in bedewed state), horizontal installation	100 %; RH incl. condensation / frost (no commissioning in bedewed state), horizontal installation	
Resistance			
Coolants and lubricants			
- Resistant to commercially available coolants and lubricants	Yes; Incl. diesel and oil droplets in the air	Yes; Incl. diesel and oil droplets in the air	

LOGO! logic module

LOGO! basic and expansion modules

SIPLUS LOGO! modular expansion modules**Technical specifications**

Article number	6AG1055-1FB00-7BA2	6AG1055-1NB10-7BA2
Based on	6ED1055-1FB00-0BA2 SIPLUS LOGO! DM8 230R V8	6ED1055-1NB10-0BA2 SIPLUS LOGO! DM16 24R V8
Use in stationary industrial systems		
- to biologically active substances according to EN 60721-3-3	Yes; Class 3B2 mold, fungus and dry rot spores (with the exception of fauna); Class 3B3 on request	Yes; Class 3B2 mold, fungus and dry rot spores (with the exception of fauna); Class 3B3 on request
- to chemically active substances according to EN 60721-3-3	Yes; Class 3C4 (RH < 75 %) incl. salt spray acc. to EN 60068-2-52 (severity degree 3); *	Yes; Class 3C4 (RH < 75 %) incl. salt spray acc. to EN 60068-2-52 (severity degree 3); *
- to mechanically active substances according to EN 60721-3-3	Yes; Class 3S4 incl. sand, dust, *	Yes; Class 3S4 incl. sand, dust, *
Use on ships/at sea		
- to biologically active substances according to EN 60721-3-6	Yes; Class 6B2 mold and fungal spores (excluding fauna); Class 6B3 on request	Yes; Class 6B2 mold and fungal spores (excluding fauna); Class 6B3 on request
- to chemically active substances according to EN 60721-3-6	Yes; Class 6C3 (RH < 75 %) incl. salt spray acc. to EN 60068-2-52 (severity degree 3); *	Yes; Class 6C3 (RH < 75 %) incl. salt spray acc. to EN 60068-2-52 (severity degree 3); *
- to mechanically active substances according to EN 60721-3-6	Yes; Class 6S3 incl. sand, dust; *	Yes; Class 6S3 incl. sand, dust; *
Usage in industrial process technology		
- Against chemically active substances acc. to EN 60654-4	Yes; Class 3 (excluding trichlorethylene)	Yes; Class 3 (excluding trichlorethylene)
- Environmental conditions for process, measuring and control systems acc. to ANSI/ISA-71.04	Yes; Level GX group A/B (excluding trichlorethylene; harmful gas concentrations up to the limits of EN 60721-3-3 class 3C4 permissible); level LC3 (salt spray) and level LB3 (oil)	Yes; Level GX group A/B (excluding trichlorethylene; harmful gas concentrations up to the limits of EN 60721-3-3 class 3C4 permissible); level LC3 (salt spray) and level LB3 (oil)
Remark		
- Note regarding classification of environmental conditions acc. to EN 60721, EN 60654-4 and ANSI/ISA-71.04	* The supplied plug covers must remain in place over the unused interfaces during operation!	* The supplied plug covers must remain in place over the unused interfaces during operation!
Conformal coating		
• Coatings for printed circuit board assemblies acc. to EN 61086	Yes; Class 2 for high availability	Yes; Class 2 for high availability
• Protection against fouling acc. to EN 60664-3	Yes; Type 1 protection	Yes; Type 1 protection
• Military testing according to MIL-I-46058C, Amendment 7	Yes; Discoloration of coating possible during service life	Yes; Discoloration of coating possible during service life
• Qualification and Performance of Electrical Insulating Compound for Printed Board Assemblies according to IPC-CC-830A	Yes; Conformal coating, Class A	Yes; Conformal coating, Class A
Article number	6AG1055-1MA00-7BA2	6AG1055-1MD00-7BA2
Based on	6ED1055-1MA00-0BA2 SIPLUS LOGO! AM2 V8	6ED1055-1MD00-0BA2 SIPLUS LOGO! AM2 RTD
Ambient conditions		
Ambient temperature during operation		
• min.	-40 °C; = Tmin; Startup @ -25 °C	-40 °C; = Tmin; Startup @ -25 °C
• max.	70 °C; = Tmax	70 °C; = Tmax
• At cold restart, min.	-25 °C; incl. condensation / frost permitted (no commissioning under condensation conditions)	-25 °C; incl. condensation / frost permitted (no commissioning under condensation conditions)
Altitude during operation relating to sea level		
• Installation altitude above sea level, max.	5 000 m	5 000 m
• Ambient air temperature-barometric pressure-altitude	Tmin ... Tmax at 1 140 hPa ... 795 hPa (-1 000 m ... +2 000 m) // Tmin ... (Tmax - 10 K) at 795 hPa ... 658 hPa (+2 000 m ... +3 500 m) // Tmin ... (Tmax -20 K) at 658 hPa ... 540 hPa (+3 500 m ... +5 000 m)	Tmin ... Tmax at 1 140 hPa ... 795 hPa (-1 000 m ... +2 000 m) // Tmin ... (Tmax - 10 K) at 795 hPa ... 658 hPa (+2 000 m ... +3 500 m) // Tmin ... (Tmax -20 K) at 658 hPa ... 540 hPa (+3 500 m ... +5 000 m)
Relative humidity		
• With condensation, tested in accordance with IEC 60068-2-38, max.	100 %; RH incl. condensation / frost (no commissioning in bedewed state), horizontal installation	100 %; RH incl. condensation / frost (no commissioning in bedewed state), horizontal installation
Resistance		
Coolants and lubricants		
- Resistant to commercially available coolants and lubricants	Yes; Incl. diesel and oil droplets in the air	Yes; Incl. diesel and oil droplets in the air

Technical specifications

Article number	6AG1055-1MA00-7BA2	6AG1055-1MD00-7BA2	
Based on	6ED1055-1MA00-0BA2 SIPLUS LOGO! AM2 V8	6ED1055-1MD00-0BA2 SIPLUS LOGO! AM2 RTD	
Use in stationary industrial systems			
- to biologically active substances according to EN 60721-3-3	Yes; Class 3B2 mold, fungus and dry rot spores (with the exception of fauna); Class 3B3 on request	Yes; Class 3B2 mold, fungus and dry rot spores (with the exception of fauna); Class 3B3 on request	
- to chemically active substances according to EN 60721-3-3	Yes; Class 3C4 (RH < 75 %) incl. salt spray acc. to EN 60068-2-52 (severity degree 3); *	Yes; Class 3C4 (RH < 75 %) incl. salt spray acc. to EN 60068-2-52 (severity degree 3); *	
- to mechanically active substances according to EN 60721-3-3	Yes; Class 3S4 incl. sand, dust, *	Yes; Class 3S4 incl. sand, dust, *	
Use on ships/at sea			
- to biologically active substances according to EN 60721-3-6	Yes; Class 6B2 mold and fungal spores (excluding fauna); Class 6B3 on request	Yes; Class 6B2 mold and fungal spores (excluding fauna); Class 6B3 on request	
- to chemically active substances according to EN 60721-3-6	Yes; Class 6C3 (RH < 75 %) incl. salt spray acc. to EN 60068-2-52 (severity degree 3); *	Yes; Class 6C3 (RH < 75 %) incl. salt spray acc. to EN 60068-2-52 (severity degree 3); *	
- to mechanically active substances according to EN 60721-3-6	Yes; Class 6S3 incl. sand, dust; *	Yes; Class 6S3 incl. sand, dust; *	
Usage in industrial process technology			
- Against chemically active substances acc. to EN 60654-4	Yes; Class 3 (excluding trichlorethylene)	Yes; Class 3 (excluding trichlorethylene)	
- Environmental conditions for process, measuring and control systems acc. to ANSI/ISA-71.04	Yes; Level GX group A/B (excluding trichlorethylene; harmful gas concentrations up to the limits of EN 60721-3-3 class 3C4 permissible); level LC3 (salt spray) and level LB3 (oil)	Yes; Level GX group A/B (excluding trichlorethylene; harmful gas concentrations up to the limits of EN 60721-3-3 class 3C4 permissible); level LC3 (salt spray) and level LB3 (oil)	
Remark			
- Note regarding classification of environmental conditions acc. to EN 60721, EN 60654-4 and ANSI/ISA-71.04	* The supplied plug covers must remain in place over the unused interfaces during operation!	* The supplied plug covers must remain in place over the unused interfaces during operation!	
Conformal coating			
• Coatings for printed circuit board assemblies acc. to EN 61086	Yes; Class 2 for high reliability	Yes; Class 2 for high reliability	
• Protection against fouling acc. to EN 60664-3	Yes; Type 1 protection	Yes; Type 1 protection	
• Military testing according to MIL-I-46058C, Amendment 7	Yes; Discoloration of coating possible during service life	Yes; Discoloration of coating possible during service life	
• Qualification and Performance of Electrical Insulating Compound for Printed Board Assemblies according to IPC-CC-830A	Yes; Conformal coating, Class A	Yes; Conformal coating, Class A	
Article number	6AG1055-1MM00-7BA2	Article number	6AG1055-1MM00-7BA2
Based on	6ED1055-1MM00-0BA2 SIPLUS LOGO! AM2 AQ V8	Based on	6ED1055-1MM00-0BA2 SIPLUS LOGO! AM2 AQ V8
Ambient conditions		Resistance	
Ambient temperature during operation		Coolants and lubricants	
• min.	-40 °C; = Tmin; Startup @ -25 °C	- Resistant to commercially available coolants and lubricants	Yes; Incl. diesel and oil droplets in the air
• max.	70 °C; = Tmax	Use in stationary industrial systems	
• At cold restart, min.	-25 °C; incl. condensation / frost permitted (no commissioning under condensation conditions)	- to biologically active substances according to EN 60721-3-3	Yes; Class 3B2 mold, fungus and dry rot spores (with the exception of fauna); Class 3B3 on request
Altitude during operation relating to sea level		- to chemically active substances according to EN 60721-3-3	Yes; Class 3C4 (RH < 75 %) incl. salt spray acc. to EN 60068-2-52 (severity degree 3); *
• Installation altitude above sea level, max.	5 000 m	- to mechanically active substances according to EN 60721-3-3	Yes; Class 3S4 incl. sand, dust, *
• Ambient air temperature-barometric pressure-altitude	Tmin ... Tmax at 1 140 hPa ... 795 hPa (-1 000 m ... +2 000 m) // Tmin ... (Tmax - 10 K) at 795 hPa ... 658 hPa (+2 000 m ... +3 500 m) // Tmin ... (Tmax -20 K) at 658 hPa ... 540 hPa (+3 500 m ... +5 000 m)	Use on ships/at sea	
Relative humidity		- to biologically active substances according to EN 60721-3-6	Yes; Class 6B2 mold and fungal spores (excluding fauna); Class 6B3 on request
• With condensation, tested in accordance with IEC 60068-2-38, max.	100 %; RH incl. condensation / frost (no commissioning in bedewed state), horizontal installation	- to chemically active substances according to EN 60721-3-6	Yes; Class 6C3 (RH < 75 %) incl. salt spray acc. to EN 60068-2-52 (severity degree 3); *
		- to mechanically active substances according to EN 60721-3-6	Yes; Class 6S3 incl. sand, dust; *

LOGO! logic module

LOGO! basic and expansion modules

SIPLUS LOGO! modular expansion modules

2

Technical specifications

Article number	6AG1055-1MM00-7BA2
Based on	6ED1055-1MM00-0BA2 SIPLUS LOGO! AM2 AQ V8
Usage in industrial process technology	
- Against chemically active substances acc. to EN 60654-4	Yes; Class 3 (excluding trichlorethylene)
- Environmental conditions for process, measuring and control systems acc. to ANSI/ISA-71.04	Yes; Level GX group A/B (excluding trichlorethylene; harmful gas concentrations up to the limits of EN 60721-3-3 class 3C4 permissible); level LC3 (salt spray) and level LB3 (oil)
Remark	
- Note regarding classification of environmental conditions acc. to EN 60721, EN 60654-4 and ANSI/ISA-71.04	* The supplied plug covers must remain in place over the unused interfaces during operation!
Conformal coating	
• Coatings for printed circuit board assemblies acc. to EN 61086	Yes; Class 2 for high reliability
• Protection against fouling acc. to EN 60664-3	Yes; Type 1 protection
• Military testing according to MIL-I-46058C, Amendment 7	Yes; Discoloration of coating possible during service life
• Qualification and Performance of Electrical Insulating Compound for Printed Board Assemblies according to IPC-CC-830A	Yes; Conformal coating, Class A

Ordering data

Article No.

SIPLUS LOGO! 8 expansion modules	
SIPLUS LOGO! DM8 24	
24 V DC supply voltage, 4 digital inputs 24 V DC, 4 digital outputs 24 V DC, 0.3 A	
Extended temperature range and exposure to media	6AG1055-1CB00-7BA2
SIPLUS LOGO! DM8 230R	
115...230 V AC/DC supply voltage, 4 digital inputs 115...230 V AC/DC, 4 relay outputs 5 A	
Extended temperature range and exposure to media	6AG1055-1FB00-7BA2
SIPLUS LOGO! DM8 24R	
24 V AC/DC supply voltage, 4 digital inputs 24 V AC/DC, 4 relay outputs 5 A	
Extended temperature range and exposure to media	6AG1055-1HB00-7BA2
SIPLUS LOGO! AM2	
12...24 V DC supply voltage, 2 analog inputs 0 to 10 V or 0 to 20 mA, 10-bit resolution	
Extended temperature range and exposure to media	6AG1055-1MA00-7BA2
SIPLUS LOGO! DM8 12/24R	
12...24 V DC supply voltage, 4 digital inputs 12...24 V DC, 4 relay outputs 5 A	
Extended temperature range and exposure to media	6AG1055-1MB00-7BA2
LOGO! AM2 RTD	
12...24 V DC supply voltage, 2 analog inputs Pt100, temperature range -50 °C to 200 °C	
Extended temperature range and exposure to media	6AG1055-1MD00-7BA2
SIPLUS LOGO! AM2 AQ	
24 V DC supply voltage, 2 analog outputs 0 to 10 V, 0/4 to 20 mA	
Extended temperature range and exposure to media	6AG1055-1MM00-7BA2
SIPLUS LOGO! DM16 24R	
24 V DC supply voltage, 8 digital inputs 24 V DC, 8 relay outputs 5 A	
Extended temperature range and exposure to media	6AG1055-1NB00-7BA2
Accessories	
LOGO!Soft Comfort V8	6ED1058-0BA08-0YA1
For programming on the PC in LAD/FBD; executes on Windows 8, 7, XP, Linux and Mac OSX; on DVD	
Front panel mounting set	
Width 8 U, with keys	6AG1057-1AA00-0AA2

SIMATIC S7-1200 Basic Controllers



3/2

I/O modules

3/2

Digital modules

3/2

SM 1222 digital output modules

3/5

SM 1223 digital input/output modules

3/9

SIPLUS digital modules

3/9

SIPLUS SM 1222 digital output modules

3/15

SIPLUS SM 1223 digital input/output modules

3/21

SIPLUS analog modules

3/21

SIPLUS SM 1231 analog input modules

3/23

SIPLUS SM 1232 analog output modules

3/25

Special modules

3/25

SIPLUS SM 1278 4xIO-Link Master

3/27

SIPLUS CMS1200 SM 1281

Condition Monitoring

3/29

SIPLUS communication

3/29

SIPLUS CP 1243-1 communication modules

SIMATIC S7-1200 Basic Controllers

I/O modules

Digital modules

SM 1222 digital output modules

Overview



- Digital outputs as supplement to the integral I/O of the CPUs
- For flexible adaptation of the controller to the corresponding task
- For subsequent expansion of the system with additional outputs

Technical specifications

Article number	6ES7222-1BF32-0XB0	6ES7222-1BH32-0XB0	6ES7222-1BH32-1XB0	6ES7222-1HF32-0XB0	6ES7222-1HH32-0XB0	6ES7222-1XF32-0XB0
	Digital Output SM1222, 8 DO, 24V DC	Digital Output SM1222, 16 DO, 24V DC	Digital Output SM1222, 16DO, 24V DC sink	Digital Output SM 1222, 8 DO, Relay	Digital Output SM1222, 16 DO, Relay	Digital Output SM 1222, 8 DO, Changeover
General information						
Product type designation	SM 1222, DQ 8x24 V DC/0.5 A	SM 1222, DQ 16x24 V DC/0.5 A	SM 1222, DO 16x 24 V DC/0.5 A Sink	SM 1222, DQ 8x relay/2 A	SM 1222, DQ 16x relay/2 A	SM 1222, DQ 8x relay/2 A
Input current						
from backplane bus 5 V DC, max.	120 mA	140 mA	140 mA	120 mA	135 mA	140 mA
Digital outputs						
• from load voltage L+, max.				11 mA/relay coil	11 mA/relay coil	16.7 mA/relay coil
Digital outputs						
Number of digital outputs	8	16	16	8	16	8
• in groups of	1	1	1	2	1	1
Current-sinking			Yes			
Short-circuit protection	No; to be provided externally	No; to be provided externally	No; to be provided externally	No; to be provided externally	No; to be provided externally	No; to be provided externally
Limitation of inductive shutdown voltage to	typ. (L+) -48 V	typ. (L+) -48 V	Typ 45 V			
Switching capacity of the outputs						
• with resistive load, max.	0.5 A	0.5 A	0.5 A	2 A	2 A	2 A
• on lamp load, max.	5 W	5 W	5 W	30 W with DC, 200 W with AC	30 W with DC, 200 W with AC	30 W with DC, 200 W with AC
Output voltage						
• Rated value (DC)	24 V	24 V	24 V	5 V DC to 30 V DC	5 V DC to 30 V DC	5 V DC to 30 V DC
• Rated value (AC)				5 V AC to 250 V AC	5 V AC to 250 V AC	5 V AC to 250 V AC
• for signal "0", max.	0.1 V; with 10 kOhm load	0.1 V; with 10 kOhm load	L+ minus 0.75 V DC with 10k Load			
• for signal "1", min.	20 V DC	20 V DC	0.5 V			
Output current						
• for signal "1" rated value	0.5 A	0.5 A	0.5 A	2 A	2 A	2 A
• for signal "0" residual current, max.	10 µA	10 µA	75 µA			
Output delay with resistive load						
• "0" to "1", max.	50 µs	50 µs	20 µs	10 ms	10 ms	10 ms
• "1" to "0", max.	200 µs	200 µs	350 µs	10 ms	10 ms	10 ms

Technical specifications

Article number	6ES7222-1BF32-0XB0	6ES7222-1BH32-0XB0	6ES7222-1BH32-1XB0	6ES7222-1HF32-0XB0	6ES7222-1HH32-0XB0	6ES7222-1XF32-0XB0
	Digital Output SM1222, 8 DO, 24V DC	Digital Output SM1222, 16 DO, 24V DC	Digital Output SM1222, 16DO, 24V DC sink	Digital Output SM 1222, 8 DO, Relay	Digital Output SM1222, 16 DO, Relay	Digital Output SM 1222, 8 DO, Changeover
Total current of the outputs (per group)						
horizontal installation						
- up to 50 °C, max.	4 A; Current per mass	8 A; Current per mass	8 A; Current per mass	10 A; Current per mass	10 A; Current per mass	2 A; Current per mass
Relay outputs						
• Number of relay outputs				8	16	8
• Rated supply voltage of relay coil L+ (DC)				24 V	24 V	24 V
• Number of operating cycles, max.				mechanically 10 million, at rated load voltage 100 000	mechanically 10 million, at rated load voltage 100 000	mechanically 10 million, at rated load voltage 100 000
Switching capacity of contacts						
- with inductive load, max.	0.5 A	0.5 A	0.5 A	2 A	2 A	2 A
- on lamp load, max.	5 W	5 W	5 W	30 W with DC, 200 W with AC	30 W with DC, 200 W with AC	30 W with DC, 200 W with AC
- with resistive load, max.	0.5 A	0.5 A	0.5 A	2 A	2 A	2 A
Cable length						
• shielded, max.	500 m	500 m	500 m	500 m	500 m	500 m
• unshielded, max.	150 m	150 m	150 m	150 m	150 m	150 m
Interrupts/diagnostics/status information						
Alarms						
• Diagnostic alarm	Yes	Yes	Yes	Yes	Yes	Yes
Diagnostics indication LED						
• for status of the outputs	Yes	Yes	Yes	Yes	Yes	Yes
Potential separation						
Potential separation digital outputs						
• between the channels				Relays	Relays	Relays
• between the channels, in groups of	1	1	1	2	4	1
• between the channels and backplane bus	500 V AC	500 V AC	500 V AC	1500 V AC for 1 minute	1500 V AC for 1 minute	1500 V AC for 1 minute
Degree and class of protection						
IP degree of protection	IP20	IP20	IP20	IP20	IP20	IP20
Standards, approvals, certificates						
CE mark	Yes	Yes	Yes	Yes	Yes	Yes
CSA approval	Yes	Yes	Yes	Yes	Yes	Yes
UL approval	Yes	Yes	Yes	Yes	Yes	Yes
cULus	Yes	Yes	Yes	Yes	Yes	Yes
FM approval	Yes	Yes	Yes	Yes	Yes	Yes
RCM (formerly C-TICK)	Yes	Yes	Yes	Yes	Yes	Yes
KC approval	Yes	Yes	Yes	Yes	Yes	Yes
Marine approval	Yes	Yes	Yes	Yes	Yes	Yes
Ambient conditions						
Free fall						
• Fall height, max.	0.3 m; five times, in product package	0.3 m; five times, in product package		0.3 m; five times, in product package	0.3 m; five times, in product package	0.3 m; five times, in product package

SIMATIC S7-1200 Basic Controllers

I/O modules

Digital modules

SM 1222 digital output modules

Technical specifications

Article number	6ES7222-1BF32-0XB0	6ES7222-1BH32-0XB0	6ES7222-1BH32-1XB0	6ES7222-1HF32-0XB0	6ES7222-1HH32-0XB0	6ES7222-1XF32-0XB0
	Digital Output SM1222, 8 DO, 24V DC	Digital Output SM1222, 16 DO, 24V DC	Digital Output SM1222, 16DO, 24V DC sink	Digital Output SM 1222, 8 DO, Relay	Digital Output SM1222, 16 DO, Relay	Digital Output SM 1222, 8 DO, Changeover
Ambient temperature during operation						
• min.	-20 °C	-20 °C	-20 °C	-20 °C	-20 °C	-20 °C
• max.	60 °C	60 °C	60 °C	60 °C	60 °C; Number of simultaneously activated outputs: 8 (no adjacent points) at 60 °C horizontal or 50 °C vertical, 16 at 55 °C horizontal or 45 °C vertical	60 °C; Number of simultaneously activated outputs: 4 (no adjacent points) at 60 °C horizontal or 50 °C vertical, 8 at 55 °C horizontal or 45 °C vertical
Connection method						
required front connector	Yes	Yes	Yes	Yes	Yes	Yes
Mechanics/material						
Enclosure material (front)						
• Plastic	Yes	Yes	Yes	Yes	Yes	Yes
Dimensions						
Width	45 mm	45 mm	45 mm	45 mm	45 mm	70 mm
Height	100 mm	100 mm	100 mm	100 mm	100 mm	100 mm
Depth	75 mm	75 mm	75 mm	75 mm	75 mm	75 mm
Weights						
Weight, approx.	180 g	220 g	220 g	190 g	260 g	310 g

Ordering data

SM 1222 digital output signal module

8 outputs, 24 V DC; 0.5 A, 5 W, isolated

6ES7222-1BF32-0XB0

16 outputs, 24 V DC; 0.5 A, 5 W, isolated

6ES7222-1BH32-0XB0

16 outputs, 24 V DC; 0.5 A, 5 W, isolated, sourcing output

6ES7222-1BH32-1XB0

8 relay outputs, 5 ... 30 V DC / 5 ... 250 V AC, 2 A, 30 W DC / 200 W AC

6ES7222-1HF32-0XB0

8 relay outputs, changeover contact, 5 ... 30 V DC / 5 ... 250 V AC, 2 A, 30 W DC / 200 W AC

6ES7222-1XF32-0XB0

16 relay outputs, 5 ... 30 V DC / 5 ... 250 V AC, 2 A, 30 W DC / 200 W AC

6ES7222-1HH32-0XB0

Extension cable for two-tier configuration

For connecting digital/analog signal modules; length 2 m

6ES7290-6AA30-0XA0

Article No.

Terminal block (spare part)

For 6ES7222-1BF32-0XB0, 6ES7222-1BH32-0XB0

- With 7 screws, tin-coated; 4 units

6ES7292-1AG30-0XA0

For 6ES7222-1HF32-0XB0

- With 7 screws, tin-coated, left coded; 4 units

6ES7292-1AG40-0XA1

For 6ES7222-1HH32-0XB0

- With 7 screws, tin-coated, right coded; 4 units

6ES7292-1AG40-0XA0

For 6ES7222-1XF32-0XB0

- With 11 screws, tin-coated; 4 units

6ES7292-1AL30-0XA0

Front flap set (spare part)

For modules with a width of 45 mm

6ES7291-1BA30-0XA0

For modules with a width of 70 mm

6ES7291-1BB30-0XA0

Overview



- Digital inputs and outputs as supplement to the integral I/O of the CPUs
- For flexible adaptation of the controller to the corresponding task
- For subsequent expansion of the system with additional inputs and outputs

Technical specifications

Article number	6ES7223-1BH32-0XB0	6ES7223-1BL32-0XB0	6ES7223-1BL32-1XB0	6ES7223-1PH32-0XB0	6ES7223-1PL32-0XB0	6ES7223-1QH32-0XB0
	Digital I/O SM 1223, 8 DI / 8 DO	Digital I/O SM 1223, 16DI/16DO	Digital I/O SM 1223, 16DI/16DO sink	Digital I/O SM 1223, 8DI/8DO	Digital I/O SM 1223, 16DI/16DO	Digital I/O SM 1223, 8DI AC/ 8DO Rly
General information						
Product type designation	SM 1223, DI 8x24 V DC, DQ 8x24 V DC	SM 1223, DI 16x24 V DC, DQ 16x24 V DC	SM 1223, DI 16x24 V DC, DO 16x 24 V DC Sink	SM 1223, DI 8x24 V DC, DQ 8x relay	SM 1223, DI 16x24 V DC, DQ 16x relay	SM 1223, DI 8x120/230 V AC, DQ 8x relay
Supply voltage						
Rated value (DC)	24 V	24 V	24 V	24 V	24 V	24 V
Input current						
from backplane bus 5 V DC, max.	145 mA	185 mA	185 mA	145 mA	180 mA	120 mA
Digital inputs						
• from load voltage L+ (without load), max.	4 mA; per channel	4 mA; per channel	4 mA; per channel	4 mA/input 11 mA/relay	4 mA/input 11 mA/relay	
Output voltage						
Power supply to the transmitters						
• present	Yes	Yes	Yes	Yes	Yes	Yes
Digital inputs						
Number of digital inputs	8	16	16	8	16	8
• in groups of	2	2	2	2	2	4
Input characteristic curve in accordance with IEC 61131, type 1	Yes	Yes	Yes	Yes	Yes	Yes
Number of simultaneously controllable inputs						
all mounting positions						
- up to 40 °C, max.	8	16	16	8	16	8
horizontal installation						
- up to 40 °C, max.	8	16	16	8	16	8
- up to 50 °C, max.	8	16	16	8	16	8
vertical installation						
- up to 40 °C, max.	8	16	16	8	16	8
Input voltage						
• Type of input voltage	DC	DC	DC	DC	DC	AC
• Rated value (DC)	24 V	24 V	24 V	24 V	24 V	
• Rated value (AC)						120/230 V AC
• for signal "0"	5 V DC at 1 mA	5 V DC at 1 mA	5 V DC at 1 mA	5 V DC at 1 mA	5 V DC at 1 mA	20 V AC at 1 mA
• for signal "1"	15 V DC at 2.5 mA	15 V DC at 2.5 mA	15 V DC at 2.5 mA	15 V DC at 2.5 mA	15 V DC at 2.5 mA	79 V AC at 2.5 mA

SIMATIC S7-1200 Basic Controllers

I/O modules

Digital modules

SM 1223 digital input/output modules

Technical specifications

Article number	6ES7223-1BH32-0XB0	6ES7223-1BL32-0XB0	6ES7223-1BL32-1XB0	6ES7223-1PH32-0XB0	6ES7223-1PL32-0XB0	6ES7223-1QH32-0XB0
Digital I/O SM 1223, 8 DI / 8 DO	Digital I/O SM 1223, 16DI/16DO	Digital I/O SM 1223, 16DI/16DO	Digital I/O SM 1223, 16DI/16DO sink	Digital I/O SM 1223, 8DI/8DO	Digital I/O SM 1223, 16DI/16DO	Digital I/O SM 1223, 8DI AC/ 8DO Rly
Input current						
• for signal "0", max. (permissible quiescent current)	1 mA	1 mA	1 mA	1 mA	1 mA	1 mA
• for signal "1", min.	2.5 mA	2.5 mA	2.5 mA	2.5 mA	2.5 mA	2.5 mA
• for signal "1", typ.	4 mA	4 mA	4 mA	4 mA	4 mA	9 mA
Input delay (for rated value of input voltage)						
for standard inputs						
- parameterizable	Yes; 0.2 ms, 0.4 ms, 0.8 ms, 1.6 ms, 3.2 ms, 6.4 ms and 12.8 ms, selectable in groups of four	Yes; 0.2 ms, 0.4 ms, 0.8 ms, 1.6 ms, 3.2 ms, 6.4 ms and 12.8 ms, selectable in groups of four	Yes; 0.2 ms, 0.4 ms, 0.8 ms, 1.6 ms, 3.2 ms, 6.4 ms and 12.8 ms, selectable in groups of four	Yes; 0.2 ms, 0.4 ms, 0.8 ms, 1.6 ms, 3.2 ms, 6.4 ms and 12.8 ms, selectable in groups of four	Yes; 0.2 ms, 0.4 ms, 0.8 ms, 1.6 ms, 3.2 ms, 6.4 ms and 12.8 ms, selectable in groups of four	Yes; 0.2 ms, 0.4 ms, 0.8 ms, 1.6 ms, 3.2 ms, 6.4 ms and 12.8 ms, selectable in groups of four
for interrupt inputs						
- parameterizable	Yes	Yes	Yes	Yes	Yes	Yes
Cable length						
• shielded, max.	500 m	500 m	500 m	500 m	500 m	500 m
• unshielded, max.	300 m	300 m	300 m	300 m	300 m	300 m
Digital outputs						
Number of digital outputs	8	16	16; Transistor current sinking	8	16	8
• in groups of	1	1	1	2	4	4
Short-circuit protection	No; to be provided externally	No; to be provided externally	Yes; 1 to 3.5 A	No; to be provided externally	No; to be provided externally	No; to be provided externally
Limitation of inductive shutdown voltage to	L+ (-48 V)	L+ (-48 V)	Typ 45 V			
Switching capacity of the outputs						
• with resistive load, max.	0.5 A	0.5 A	0.5 A	2 A	2 A	2 A
• on lamp load, max.	5 W	5 W	5 W	30 W with DC, 200 W with AC	30 W with DC, 200 W with AC	30 W with DC, 200 W with AC
Output voltage						
• Rated value (DC)	24 V	24 V	24 V	5 V DC to 30 V DC	5 V DC to 30 V DC	5 V DC to 30 V DC
• Rated value (AC)				5 V AC to 250 V AC	5 V AC to 250 V AC	5 V AC to 250 V AC
• for signal "0", max.	0.1 V; with 10 kOhm load	0.1 V; with 10 kOhm load	L+ minus 0.75 V DC with 10k Load			
• for signal "1", min.	20 V DC	20 V DC	0.5 V			
Output current						
• for signal "1" permissible range, max.	0.5 A	0.5 A	0.5 A	2 A	2 A	2 A
• for signal "0" residual current, max.	10 µA	10 µA	75 µA			
Output delay with resistive load						
• "0" to "1", max.	50 µs	50 µs	20 µs	10 ms	10 ms	10 ms
• "1" to "0", max.	200 µs	200 µs	350 µs	10 ms	10 ms	10 ms
Total current of the outputs (per group)						
horizontal installation						
- up to 50 °C, max.	4 A; Current per mass	8 A; Current per mass	8 A; Current per mass	10 A; Current per mass	8 A; Current per mass	8 A; Current per mass
Relay outputs						
• Number of relay outputs				8	16	8
• Rated supply voltage of relay coil L+ (DC)				24 V	24 V	24 V
• Number of operating cycles, max.				mechanically 10 million, at rated load voltage 100 000	mechanically 10 million, at rated load voltage 100 000	mechanically 10 million, at rated load voltage 100 000

Technical specifications

Article number	6ES7223-1BH32-0XB0	6ES7223-1BL32-0XB0	6ES7223-1BL32-1XB0	6ES7223-1PH32-0XB0	6ES7223-1PL32-0XB0	6ES7223-1QH32-0XB0
	Digital I/O SM 1223, 8 DI / 8 DO	Digital I/O SM 1223, 16DI/16DO	Digital I/O SM 1223, 16DI/16DO sink	Digital I/O SM 1223, 8DI/8DO	Digital I/O SM 1223, 16DI/16DO	Digital I/O SM 1223, 8DI AC/ 8DO Rly
Switching capacity of contacts						
- with inductive load, max.		0.5 A	0.5 A	2 A	2 A	2 A
- on lamp load, max.		5 W	5 W	30 W with DC, 200 W with AC	30 W with DC, 200 W with AC	30 W with DC, 200 W with AC
- with resistive load, max.		0.5 A	0.5 A	2 A	2 A	2 A
Cable length						
• shielded, max.	500 m	500 m	500 m	500 m	500 m	500 m
• unshielded, max.	150 m	150 m	150 m	150 m	150 m	150 m
Interrupts/diagnostics/ status information						
Alarms						
• Diagnostic alarm	Yes	Yes	Yes	Yes	Yes	Yes
Diagnostics indication LED						
• for status of the inputs	Yes	Yes	Yes	Yes	Yes	Yes
• for status of the outputs	Yes	Yes	Yes	Yes	Yes	Yes
Potential separation						
Potential separation digital inputs						
• between the channels, in groups of	2	2	2	2	2	2
Potential separation digital outputs						
• between the channels				Relays	Relays	Relays
• between the channels, in groups of	1	1	1	2	4	2
• between the channels and backplane bus	500 V AC	500 V AC	500 V AC	1500 V AC for 1 minute	1500 V AC for 1 minute	1500 V AC for 1 minute
Degree and class of protection						
IP degree of protection	IP20	IP20	IP20	IP20	IP20	IP20
Standards, approvals, certificates						
CE mark	Yes	Yes	Yes	Yes	Yes	Yes
CSA approval	Yes	Yes	Yes	Yes	Yes	Yes
UL approval	Yes	Yes	Yes	Yes	Yes	Yes
cULus	Yes	Yes	Yes	Yes	Yes	Yes
FM approval	Yes	Yes	Yes	Yes	Yes	Yes
RCM (formerly C-TICK)	Yes	Yes	Yes	Yes	Yes	Yes
KC approval	Yes	Yes	Yes	Yes	Yes	Yes
Marine approval	Yes	Yes	Yes	Yes	Yes	Yes
Ambient conditions						
Free fall						
• Fall height, max.	0.3 m; five times, in product package	0.3 m; five times, in product package	0.3 m; five times, in product package	0.3 m; five times, in product package	0.3 m; five times, in product package	0.3 m; five times, in product package
Ambient temperature during operation						
• min.	-20 °C	-20 °C	-20 °C	-20 °C	-20 °C	-20 °C
• max.	60 °C	60 °C	60 °C	60 °C	60 °C; Number of simultaneously activated outputs: 8 (no adjacent points) at 60 °C horizontal or 50 °C vertical, 16 at 55 °C horizontal or 45 °C vertical	60 °C; Number of simultaneously activated outputs: 4 (no adjacent points) at 60 °C horizontal or 50 °C vertical, 8 at 55 °C horizontal or 45 °C vertical

SIMATIC S7-1200 Basic Controllers

I/O modules

Digital modules

SM 1223 digital input/output modules

Technical specifications

Article number	6ES7223-1BH32-0XB0	6ES7223-1BL32-0XB0	6ES7223-1BL32-1XB0	6ES7223-1PH32-0XB0	6ES7223-1PL32-0XB0	6ES7223-1QH32-0XB0
Digital I/O SM 1223, 8 DI / 8 DO	Digital I/O SM 1223, 16DI/16DO	Digital I/O SM 1223, 16DI/16DO	Digital I/O SM 1223, 16DI/16DO sink	Digital I/O SM 1223, 8DI/8DO	Digital I/O SM 1223, 16DI/16DO	Digital I/O SM 1223, 8DI AC/ 8DO Rly
Connection method						
required front connector	Yes	Yes	Yes	Yes	Yes	Yes
Mechanics/material						
Enclosure material (front)						
• Plastic	Yes	Yes	Yes	Yes	Yes	Yes
Dimensions						
Width	45 mm	70 mm	70 mm	45 mm	70 mm	45 mm
Height	100 mm	100 mm	100 mm	100 mm	100 mm	100 mm
Depth	75 mm	75 mm	75 mm	75 mm	75 mm	75 mm
Weights						
Weight, approx.	210 g	310 g	310 g	230 g	350 g	230 g

Ordering data

SM 1223 digital input/output signal module

8 inputs, 24 V DC,
IEC type 1 current sinking;
8 x 24 V DC transistor outputs,
0.5 A, 5 W

16 inputs, 24 V DC,
IEC type 1 current sinking;
16 x 24 V DC transistor outputs,
0.5 A, 5 W

16 inputs, 24 V DC,
IEC type 1 current sinking;
16 x 24 V DC transistor outputs,
0.5 A, 5 W, sourcing output

8 inputs, 24 V DC,
IEC type 1 current sinking;
8 relay outputs,
5 ... 30 V DC/5 ... 250 V AC,
2 A, 30 W DC/200 W AC

16 inputs, 24 V DC,
IEC type 1 current sinking;
16 relay outputs,
5 ... 30 V DC/5 ... 250 V AC,
2 A, 30 W DC/200 W AC

8 inputs, 120/230 V AC;
8 relay outputs,
5 ... 30 V DC/5 ... 250 V AC,
2 A, 30 W DC/200 W AC

Article No.

6ES7223-1BH32-0XB0

6ES7223-1BL32-0XB0

6ES7223-1BL32-1XB0

6ES7223-1PH32-0XB0

6ES7223-1PL32-0XB0

6ES7223-1QH32-0XB0

Article No.

Extension cable for two-tier configuration

for connecting digital/analog signal modules;
length 2 m

Terminal block (spare part)

For 6ES7223-1BH32-0XB0

- With 7 screws, tin-coated; 4 units

For 6ES7223-1BL32-0XB0

- With 11 screws, tin-coated; 4 units

For 6ES7223-1PH32-0XB0

- With 7 screws, tin-coated; 4 units

- With 7 screws, tin-coated, right coded; 4 units

For 6ES7223-1PL32-0XB0

- With 11 screws, tin-coated; 4 units

- With 11 screws, tin-coated, right coded; 4 units

For 6ES7223-1PL32-0XB0

- With 7 screws, tin-coated, right coded; 4 units

Front flap set (spare part)

For modules with a width of 45 mm

For modules with a width of 70 mm

6ES7290-6AA30-0XA0

6ES7292-1AG30-0XA0

6ES7292-1AL30-0XA0

6ES7292-1AG30-0XA0

6ES7292-1AG40-0XA0

6ES7292-1AL30-0XA0

6ES7292-1AL40-0XA0

6ES7292-1AG40-0XA0

6ES7291-1BA30-0XA0

6ES7291-1BB30-0XA0

Overview



- Digital outputs as a supplement to the integral I/O of the CPUs
- For flexible adaptation of the controller to the corresponding task
- For subsequent expansion of the system with additional outputs
- From +60 °C to +70 °C, max. 50% of the inputs can be controlled simultaneously

Note:

SIPLUS extreme products are based on SIMATIC standard products. The contents listed here were taken from the respective standard products. SIPLUS extreme-specific information was added.

3

Technical specifications

Article number	6AG1222-1BF32-2XB0	6AG1222-1BF32-4XB0	6AG1222-1BH32-2XB0	6AG1222-1BH32-4XB0
Based on	6ES7222-1BF32-0XB0 SIPLUS S7-1200 SM 1222 8DQ	6ES7222-1BF32-0XB0 SIPLUS S7-1200 SM 1222 8DQ	6ES7222-1BH32-0XB0 SIPLUS S7-1200 SM 1222 16DQ	6ES7222-1BH32-0XB0 SIPLUS S7-1200 SM 1222 16DQ
Ambient conditions				
Free fall				
• Fall height, max.	0.3 m; five times, in product package	0.3 m; five times, in product package	0.3 m; five times, in product package	0.3 m; five times, in product package
Ambient temperature during operation				
• min.	-40 °C; = Tmin (incl. condensation/frost); start-up @ -25 °C	-20 °C; = Tmin (incl. condensation/frost); start-up @ 0 °C	-40 °C; = Tmin (incl. condensation/frost); start-up @ -25 °C	-20 °C; = Tmin (incl. condensation/frost); start-up @ 0 °C
• max.	70 °C; = Tmax; Tmax > +60 °C number of simultaneously activated outputs 4 (no adjacent points) for horizontal mounting position	60 °C; = Tmax	70 °C; = Tmax; Tmax > +60 °C number of simultaneously activated outputs 8 (no adjacent points) for horizontal mounting position	60 °C; = Tmax
• At cold restart, min.	-25 °C	0 °C	-25 °C	0 °C
Altitude during operation relating to sea level				
• Installation altitude above sea level, max.	5 000 m	5 000 m	5 000 m	5 000 m
• Ambient air temperature-barometric pressure-altitude	Tmin ... Tmax at 1 140 hPa ... 795 hPa (-1 000 m ... +2 000 m) // Tmin ... (Tmax - 10 K) at 795 hPa ... 658 hPa (+2 000 m ... +3 500 m) // Tmin ... (Tmax -20 K) at 658 hPa ... 540 hPa (+3 500 m ... +5 000 m)	Tmin ... Tmax at 1 140 hPa ... 795 hPa (-1 000 m ... +2 000 m) // Tmin ... (Tmax - 10 K) at 795 hPa ... 658 hPa (+2 000 m ... +3 500 m) // Tmin ... (Tmax -20 K) at 658 hPa ... 540 hPa (+3 500 m ... +5 000 m)	Tmin ... Tmax at 1 140 hPa ... 795 hPa (-1 000 m ... +2 000 m) // Tmin ... (Tmax - 10 K) at 795 hPa ... 658 hPa (+2 000 m ... +3 500 m) // Tmin ... (Tmax -20 K) at 658 hPa ... 540 hPa (+3 500 m ... +5 000 m)	Tmin ... Tmax at 1 140 hPa ... 795 hPa (-1 000 m ... +2 000 m) // Tmin ... (Tmax - 10 K) at 795 hPa ... 658 hPa (+2 000 m ... +3 500 m) // Tmin ... (Tmax -20 K) at 658 hPa ... 540 hPa (+3 500 m ... +5 000 m)
Relative humidity				
• With condensation, tested in accordance with IEC 60068-2-38, max.	100 %; RH incl. condensation/frost (no commissioning under condensation conditions)	100 %; RH incl. condensation/frost (no commissioning under condensation conditions)	100 %; RH incl. condensation/frost (no commissioning under condensation conditions)	100 %; RH incl. condensation/frost (no commissioning under condensation conditions)
Resistance				
Coolants and lubricants				
- Resistant to commercially available coolants and lubricants	Yes; Incl. diesel and oil droplets in the air	Yes; Incl. diesel and oil droplets in the air	Yes; Incl. diesel and oil droplets in the air	Yes; Incl. diesel and oil droplets in the air

SIMATIC S7-1200 Basic Controllers

I/O modules

SIPLUS digital modules

SIPLUS SM 1222 digital output modules

Technical specifications

Article number	6AG1222-1BF32-2XB0	6AG1222-1BF32-4XB0	6AG1222-1BH32-2XB0	6AG1222-1BH32-4XB0
Based on	6ES7222-1BF32-0XB0 SIPLUS S7-1200 SM 1222 8DQ	6ES7222-1BF32-0XB0 SIPLUS S7-1200 SM 1222 8DQ	6ES7222-1BH32-0XB0 SIPLUS S7-1200 SM 1222 16DQ	6ES7222-1BH32-0XB0 SIPLUS S7-1200 SM 1222 16DQ
Use in stationary industrial systems				
- to biologically active substances according to EN 60721-3-3	Yes; Class 3B2 mold, fungus and dry rot spores (with the exception of fauna); Class 3B3 on request	Yes; Class 3B2 mold, fungus and dry rot spores (with the exception of fauna); Class 3B3 on request	Yes; Class 3B2 mold, fungus and dry rot spores (with the exception of fauna); Class 3B3 on request	Yes; Class 3B2 mold, fungus and dry rot spores (with the exception of fauna); Class 3B3 on request
- to chemically active substances according to EN 60721-3-3	Yes; Class 3C4 (RH < 75 %) incl. salt spray acc. to EN 60068-2-52 (severity degree 3); *	Yes; Class 3C4 (RH < 75 %) incl. salt spray acc. to EN 60068-2-52 (severity degree 3); *	Yes; Class 3C4 (RH < 75 %) incl. salt spray acc. to EN 60068-2-52 (severity degree 3); *	Yes; Class 3C4 (RH < 75 %) incl. salt spray acc. to EN 60068-2-52 (severity degree 3); *
- to mechanically active substances according to EN 60721-3-3	Yes; Class 3S4 incl. sand, dust; *	Yes; Class 3S4 incl. sand, dust; *	Yes; Class 3S4 incl. sand, dust; *	Yes; Class 3S4 incl. sand, dust; *
Use on ships/at sea				
- to biologically active substances according to EN 60721-3-6	Yes; Class 6B2 mold and fungal spores (excluding fauna); Class 6B3 on request	Yes; Class 6B2 mold and fungal spores (excluding fauna); Class 6B3 on request	Yes; Class 6B2 mold and fungal spores (excluding fauna); Class 6B3 on request	Yes; Class 6B2 mold and fungal spores (excluding fauna); Class 6B3 on request
- to chemically active substances according to EN 60721-3-6	Yes; Class 6C3 (RH < 75 %) incl. salt spray acc. to EN 60068-2-52 (severity degree 3); *	Yes; Class 6C3 (RH < 75 %) incl. salt spray acc. to EN 60068-2-52 (severity degree 3); *	Yes; Class 6C3 (RH < 75 %) incl. salt spray acc. to EN 60068-2-52 (severity degree 3); *	Yes; Class 6C3 (RH < 75 %) incl. salt spray acc. to EN 60068-2-52 (severity degree 3); *
- to mechanically active substances according to EN 60721-3-6	Yes; Class 6S3 incl. sand, dust; *	Yes; Class 6S3 incl. sand, dust; *	Yes; Class 6S3 incl. sand, dust; *	Yes; Class 6S3 incl. sand, dust; *
Usage in industrial process technology				
- Against chemically active substances acc. to EN 60654-4	Yes; Class 3 (excluding trichlorethylene)	Yes; Class 3 (excluding trichlorethylene)	Yes; Class 3 (excluding trichlorethylene)	Yes; Class 3 (excluding trichlorethylene)
- Environmental conditions for process, measuring and control systems acc. to ANSI/ISA-71.04	Yes; Level GX group A/B (excluding trichlorethylene; harmful gas concentrations up to the limits of EN 60721-3-3 class 3C4 permissible); level LC3 (salt spray) and level LB3 (oil)	Yes; Level GX group A/B (excluding trichlorethylene; harmful gas concentrations up to the limits of EN 60721-3-3 class 3C4 permissible); level LC3 (salt spray) and level LB3 (oil)	Yes; Level GX group A/B (excluding trichlorethylene; harmful gas concentrations up to the limits of EN 60721-3-3 class 3C4 permissible); level LC3 (salt spray) and level LB3 (oil)	Yes; Level GX group A/B (excluding trichlorethylene; harmful gas concentrations up to the limits of EN 60721-3-3 class 3C4 permissible); level LC3 (salt spray) and level LB3 (oil)
Remark				
- Note regarding classification of environmental conditions acc. to EN 60721, EN 60654-4 and ANSI/ISA-71.04	* The supplied plug covers must remain in place over the unused interfaces during operation!	* The supplied plug covers must remain in place over the unused interfaces during operation!	* The supplied plug covers must remain in place over the unused interfaces during operation!	* The supplied plug covers must remain in place over the unused interfaces during operation!
Conformal coating				
• Coatings for printed circuit board assemblies acc. to EN 61086	Yes; Class 2 for high availability	Yes; Class 2 for high availability	Yes; Class 2 for high availability	Yes; Class 2 for high availability
• Protection against fouling acc. to EN 60664-3	Yes; Type 1 protection	Yes; Type 1 protection	Yes; Type 1 protection	Yes; Type 1 protection
• Military testing according to MIL-I-46058C, Amendment 7	Yes; Discoloration of coating possible during service life	Yes; Discoloration of coating possible during service life	Yes; Discoloration of coating possible during service life	Yes; Discoloration of coating possible during service life
• Qualification and Performance of Electrical Insulating Compound for Printed Board Assemblies according to IPC-CC-830A	Yes; Conformal coating, Class A	Yes; Conformal coating, Class A	Yes; Conformal coating, Class A	Yes; Conformal coating, Class A

Technical specifications

Article number	6AG1222-1HF32-2XB0	6AG1222-1HF32-4XB0	6AG1222-1XF32-2XB0	6AG1222-1XF32-4XB0
Based on	6ES7222-1HF32-0XB0 SIPLUS S7-1200 SM 1222 8DQ RLY	6ES7222-1HF32-0XB0 SIPLUS S7-1200 SM 1222 8DQ RLY	6ES7222-1XF32-0XB0 SIPLUS S7-1200 SM 1222 8DQ RLY	6ES7222-1XF32-0XB0 SIPLUS S7-1200 SM 1222 8DQ RLY
Ambient conditions				
Free fall				
• Fall height, max.	0.3 m; five times, in product package	0.3 m; five times, in product package		
Ambient temperature during operation				
• min.	-40 °C; = Tmin (incl. condensation/frost); start-up @ -25 °C	-20 °C; = Tmin (incl. condensation/frost); start-up @ 0 °C	-40 °C; = Tmin (incl. condensation/frost); start-up @ -25 °C	-20 °C; = Tmin (incl. condensation/frost); start-up @ 0 °C
• max.	70 °C; = Tmax; Tmax > +60 °C number of simultaneously activated outputs 4 (no adjacent points) for horizontal mounting position	60 °C; = Tmax	70 °C; = Tmax; Tmax > +60 °C number of simultaneously activated outputs 4 (no adjacent points) for horizontal mounting position	60 °C; = Tmax
• At cold restart, min.	-25 °C	0 °C	-25 °C	0 °C
Altitude during operation relating to sea level				
• Installation altitude above sea level, max.	2 000 m	2 000 m	2 000 m	2 000 m
• Ambient air temperature-barometric pressure-altitude	Tmin ... Tmax at 1 140 hPa ... 795 hPa (-1 000 m ... +2 000 m) // Tmin ... (Tmax - 10 K) at 795 hPa ... 658 hPa (+2 000 m ... +3 500 m) // Tmin ... (Tmax - 20 K) at 658 hPa ... 540 hPa (+3 500 m ... +5 000 m); above 2 000 m max. 132 V AC	Tmin ... Tmax at 1 140 hPa ... 795 hPa (-1 000 m ... +2 000 m) // Tmin ... (Tmax - 10 K) at 795 hPa ... 658 hPa (+2 000 m ... +3 500 m) // Tmin ... (Tmax - 20 K) at 658 hPa ... 540 hPa (+3 500 m ... +5 000 m); above 2 000 m max. 132 V AC	Tmin ... Tmax at 1 140 hPa ... 795 hPa (-1 000 m ... +2 000 m) // Tmin ... (Tmax - 10 K) at 795 hPa ... 658 hPa (+2 000 m ... +3 500 m) // Tmin ... (Tmax - 20 K) at 658 hPa ... 540 hPa (+3 500 m ... +5 000 m); above 2 000 m max. 132 V AC	Tmin ... Tmax at 1 140 hPa ... 795 hPa (-1 000 m ... +2 000 m) // Tmin ... (Tmax - 10 K) at 795 hPa ... 658 hPa (+2 000 m ... +3 500 m) // Tmin ... (Tmax - 20 K) at 658 hPa ... 540 hPa (+3 500 m ... +5 000 m); above 2 000 m max. 132 V AC
Relative humidity				
• With condensation, tested in accordance with IEC 60068-2-38, max.	100 %; RH incl. condensation/frost (no commissioning under condensation conditions)	100 %; RH incl. condensation/frost (no commissioning under condensation conditions)	100 %; RH incl. condensation/frost (no commissioning under condensation conditions)	100 %; RH incl. condensation/frost (no commissioning under condensation conditions)
Resistance				
Coolants and lubricants				
- Resistant to commercially available coolants and lubricants	Yes; Incl. diesel and oil droplets in the air	Yes; Incl. diesel and oil droplets in the air	Yes; Incl. diesel and oil droplets in the air	Yes; Incl. diesel and oil droplets in the air
Use in stationary industrial systems				
- to biologically active substances according to EN 60721-3-3	Yes; Class 3B2 mold, fungus and dry rot spores (with the exception of fauna); Class 3B3 on request	Yes; Class 3B2 mold, fungus and dry rot spores (with the exception of fauna); Class 3B3 on request	Yes; Class 3B2 mold, fungus and dry rot spores (with the exception of fauna); Class 3B3 on request	Yes; Class 3B2 mold, fungus and dry rot spores (with the exception of fauna); Class 3B3 on request
- to chemically active substances according to EN 60721-3-3	Yes; Class 3C4 (RH < 75 %) incl. salt spray acc. to EN 60068-2-52 (severity degree 3); *	Yes; Class 3C4 (RH < 75 %) incl. salt spray acc. to EN 60068-2-52 (severity degree 3); *	Yes; Class 3C4 (RH < 75 %) incl. salt spray acc. to EN 60068-2-52 (severity degree 3); *	Yes; Class 3C4 (RH < 75 %) incl. salt spray acc. to EN 60068-2-52 (severity degree 3); *
- to mechanically active substances according to EN 60721-3-3	Yes; Class 3S4 incl. sand, dust; *	Yes; Class 3S4 incl. sand, dust; *	Yes; Class 3S4 incl. sand, dust; *	Yes; Class 3S4 incl. sand, dust; *
Use on ships/at sea				
- to biologically active substances according to EN 60721-3-6	Yes; Class 6B2 mold and fungal spores (excluding fauna); Class 6B3 on request	Yes; Class 6B2 mold and fungal spores (excluding fauna); Class 6B3 on request	Yes; Class 6B2 mold and fungal spores (excluding fauna); Class 6B3 on request	Yes; Class 6B2 mold and fungal spores (excluding fauna); Class 6B3 on request
- to chemically active substances according to EN 60721-3-6	Yes; Class 6C3 (RH < 75 %) incl. salt spray acc. to EN 60068-2-52 (severity degree 3); *	Yes; Class 6C3 (RH < 75 %) incl. salt spray acc. to EN 60068-2-52 (severity degree 3); *	Yes; Class 6C3 (RH < 75 %) incl. salt spray acc. to EN 60068-2-52 (severity degree 3); *	Yes; Class 6C3 (RH < 75 %) incl. salt spray acc. to EN 60068-2-52 (severity degree 3); *
- to mechanically active substances according to EN 60721-3-6	Yes; Class 6S3 incl. sand, dust; *	Yes; Class 6S3 incl. sand, dust; *	Yes; Class 6S3 incl. sand, dust; *	Yes; Class 6S3 incl. sand, dust; *

SIMATIC S7-1200 Basic Controllers

I/O modules

SIPLUS digital modules

SIPLUS SM 1222 digital output modules

Technical specifications

Article number	6AG1222-1HF32-2XB0	6AG1222-1HF32-4XB0	6AG1222-1XF32-2XB0	6AG1222-1XF32-4XB0
Based on	6ES7222-1HF32-0XB0 SIPLUS S7-1200 SM 1222 8DQ RLY	6ES7222-1HF32-0XB0 SIPLUS S7-1200 SM 1222 8DQ RLY	6ES7222-1XF32-0XB0 SIPLUS S7-1200 SM 1222 8DQ RLY	6ES7222-1XF32-0XB0 SIPLUS S7-1200 SM 1222 8DQ RLY
Usage in industrial process technology				
- Against chemically active substances acc. to EN 60654-4	Yes; Class 3 (excluding trichlorethylene)	Yes; Class 3 (excluding trichlorethylene)	Yes; Class 3 (excluding trichlorethylene)	Yes; Class 3 (excluding trichlorethylene)
- Environmental conditions for process, measuring and control systems acc. to ANSI/ISA-71.04	Yes; Level GX group A/B (excluding trichlorethylene; harmful gas concentrations up to the limits of EN 60721-3-3 class 3C4 permissible); level LC3 (salt spray) and level LB3 (oil)	Yes; Level GX group A/B (excluding trichlorethylene; harmful gas concentrations up to the limits of EN 60721-3-3 class 3C4 permissible); level LC3 (salt spray) and level LB3 (oil)	Yes; Level GX group A/B (excluding trichlorethylene; harmful gas concentrations up to the limits of EN 60721-3-3 class 3C4 permissible); level LC3 (salt spray) and level LB3 (oil)	Yes; Level GX group A/B (excluding trichlorethylene; harmful gas concentrations up to the limits of EN 60721-3-3 class 3C4 permissible); level LC3 (salt spray) and level LB3 (oil)
Remark				
- Note regarding classification of environmental conditions acc. to EN 60721, EN 60654-4 and ANSI/ISA-71.04	* The supplied plug covers must remain in place over the unused interfaces during operation!	* The supplied plug covers must remain in place over the unused interfaces during operation!	* The supplied plug covers must remain in place over the unused interfaces during operation!	* The supplied plug covers must remain in place over the unused interfaces during operation!
Conformal coating				
• Coatings for printed circuit board assemblies acc. to EN 61086	Yes; Class 2 for high availability	Yes; Class 2 for high availability	Yes; Class 2 for high availability	Yes; Class 2 for high availability
• Protection against fouling acc. to EN 60664-3	Yes; Type 1 protection	Yes; Type 1 protection	Yes; Type 1 protection	Yes; Type 1 protection
• Military testing according to MIL-I-46058C, Amendment 7	Yes; Discoloration of coating possible during service life	Yes; Discoloration of coating possible during service life	Yes; Discoloration of coating possible during service life	Yes; Discoloration of coating possible during service life
• Qualification and Performance of Electrical Insulating Compound for Printed Board Assemblies according to IPC-CC-830A	Yes; Conformal coating, Class A	Yes; Conformal coating, Class A	Yes; Conformal coating, Class A	Yes; Conformal coating, Class A
Article number	6AG1222-1HH32-2XB0		6AG1222-1HH32-4XB0	
Based on	6ES7222-1HH32-0XB0 SIPLUS S7-1200 SM 1222 16DQ RLY		6ES7222-1HH32-0XB0 SIPLUS S7-1200 SM 1222 16DQ RLY	
Ambient conditions				
Free fall				
• Fall height, max.	0.3 m; five times, in product package		0.3 m; five times, in product package	
Ambient temperature during operation				
• min.	-40 °C; = Tmin (incl. condensation/frost); start-up @ -25 °C		-20 °C; = Tmin (incl. condensation/frost); start-up @ 0 °C	
• max.	70 °C; = Tmax; Tmax > +60 °C number of simultaneously activated outputs 8 (no adjacent points) for horizontal mounting position		60 °C; = Tmax	
• At cold restart, min.	-25 °C		0 °C	
Altitude during operation relating to sea level				
• Installation altitude above sea level, max.	2 000 m		2 000 m	
• Ambient air temperature-barometric pressure-altitude	Tmin ... Tmax at 1 140 hPa ... 795 hPa (-1 000 m ... +2 000 m) // Tmin ... (Tmax - 10 K) at 795 hPa ... 658 hPa (+2 000 m ... +3 500 m) // Tmin ... (Tmax - 20 K) at 658 hPa ... 540 hPa (+3 500 m ... +5 000 m); above 2 000 m max. 132 V AC		Tmin ... Tmax at 1 140 hPa ... 795 hPa (-1 000 m ... +2 000 m) // Tmin ... (Tmax - 10 K) at 795 hPa ... 658 hPa (+2 000 m ... +3 500 m) // Tmin ... (Tmax - 20 K) at 658 hPa ... 540 hPa (+3 500 m ... +5 000 m); above 2 000 m max. 132 V AC	
Relative humidity				
• With condensation, tested in accordance with IEC 60068-2-38, max.	100 %; RH incl. condensation/frost (no commissioning under condensation conditions)		100 %; RH incl. condensation/frost (no commissioning under condensation conditions)	
Resistance				
Coolants and lubricants				
- Resistant to commercially available coolants and lubricants	Yes; Incl. diesel and oil droplets in the air		Yes; Incl. diesel and oil droplets in the air	

Technical specifications

Article number	6AG1222-1HH32-2XB0	6AG1222-1HH32-4XB0
Based on	6ES7222-1HH32-0XB0 SIPLUS S7-1200 SM 1222 16DQ RLY	6ES7222-1HH32-0XB0 SIPLUS S7-1200 SM 1222 16DQ RLY
Use in stationary industrial systems		
- to biologically active substances according to EN 60721-3-3	Yes; Class 3B2 mold, fungus and dry rot spores (with the exception of fauna); Class 3B3 on request	Yes; Class 3B2 mold, fungus and dry rot spores (with the exception of fauna); Class 3B3 on request
- to chemically active substances according to EN 60721-3-3	Yes; Class 3C4 (RH < 75 %) incl. salt spray acc. to EN 60068-2-52 (severity degree 3); *	Yes; Class 3C4 (RH < 75 %) incl. salt spray acc. to EN 60068-2-52 (severity degree 3); *
- to mechanically active substances according to EN 60721-3-3	Yes; Class 3S4 incl. sand, dust, *	Yes; Class 3S4 incl. sand, dust, *
Use on ships/at sea		
- to biologically active substances according to EN 60721-3-6	Yes; Class 6B2 mold and fungal spores (excluding fauna); Class 6B3 on request	Yes; Class 6B2 mold and fungal spores (excluding fauna); Class 6B3 on request
- to chemically active substances according to EN 60721-3-6	Yes; Class 6C3 (RH < 75 %) incl. salt spray acc. to EN 60068-2-52 (severity degree 3); *	Yes; Class 6C3 (RH < 75 %) incl. salt spray acc. to EN 60068-2-52 (severity degree 3); *
- to mechanically active substances according to EN 60721-3-6	Yes; Class 6S3 incl. sand, dust; *	Yes; Class 6S3 incl. sand, dust; *
Usage in industrial process technology		
- Against chemically active substances acc. to EN 60654-4	Yes; Class 3 (excluding trichlorethylene)	Yes; Class 3 (excluding trichlorethylene)
- Environmental conditions for process, measuring and control systems acc. to ANSI/ISA-71.04	Yes; Level GX group A/B (excluding trichlorethylene; harmful gas concentrations up to the limits of EN 60721-3-3 class 3C4 permissible); level LC3 (salt spray) and level LB3 (oil)	Yes; Level GX group A/B (excluding trichlorethylene; harmful gas concentrations up to the limits of EN 60721-3-3 class 3C4 permissible); level LC3 (salt spray) and level LB3 (oil)
Remark		
- Note regarding classification of environmental conditions acc. to EN 60721, EN 60654-4 and ANSI/ISA-71.04	* The supplied plug covers must remain in place over the unused interfaces during operation!	* The supplied plug covers must remain in place over the unused interfaces during operation!
Conformal coating		
• Coatings for printed circuit board assemblies acc. to EN 61086	Yes; Class 2 for high availability	Yes; Class 2 for high availability
• Protection against fouling acc. to EN 60664-3	Yes; Type 1 protection	Yes; Type 1 protection
• Military testing according to MIL-I-46058C, Amendment 7	Yes; Discoloration of coating possible during service life	Yes; Discoloration of coating possible during service life
• Qualification and Performance of Electrical Insulating Compound for Printed Board Assemblies according to IPC-CC-830A	Yes; Conformal coating, Class A	Yes; Conformal coating, Class A

SIMATIC S7-1200 Basic Controllers

I/O modules

SIPLUS digital modules

SIPLUS SM 1222 digital output modules

3

Ordering data	Article No.
SIPLUS SM 1222 digital output signal module (Extended temperature range and exposure to media)	
8 outputs, 24 V DC; 0.5 A, 5 W, isolated <ul style="list-style-type: none"> For areas with exceptional exposure to media (conformal coating) -25 ... +70 °C, from +60 ... +70°C number of simultaneously controllable inputs and outputs max. 50% 	6AG1222-1BF32-4XB0 6AG1222-1BF32-2XB0
16 outputs, 24 V DC; 0.5 A, 5 W, isolated <ul style="list-style-type: none"> For areas with exceptional exposure to media (conformal coating) -25 ... +70 °C, from +60 ... +70°C number of simultaneously controllable inputs and outputs max. 50% 	6AG1222-1BH32-4XB0 6AG1222-1BH32-2XB0
8 outputs, 5 ... 30 V DC/5 ... 250 V AC, relay 2 A, 30 W DC/200 W AC <ul style="list-style-type: none"> For areas with exceptional exposure to media (conformal coating) -25 ... +70 °C, from +60 ... +70°C number of simultaneously controllable inputs and outputs max. 50% 	6AG1222-1HF32-4XB0 6AG1222-1HF32-2XB0
8 relay outputs, changeover contact, 5 ... 30 V DC / 5 ... 250 V AC, 2 A, 30 W DC / 200 W AC <ul style="list-style-type: none"> For areas with exceptional exposure to media (conformal coating) -40 ... +70 °C, from +60 ... +70°C number of simultaneously controllable inputs and outputs max. 50% 	6AG1222-1XF32-4XB0 6AG1222-1XF32-2XB0
16 outputs, 5 ... 30 V DC/5 ... 250 V AC, relay 2 A, 30 W DC/200 W AC <ul style="list-style-type: none"> For areas with exceptional exposure to environmental substances (conformal coating) -25 ... +70 °C, from +60 ... +70°C number of simultaneously controllable inputs and outputs max. 50% 	6AG1222-1HH32-4XB0 6AG1222-1HH32-2XB0
Accessories	See SIMATIC S7-1200 SM 1222 digital output modules, page 3/4

Overview



- Digital inputs and outputs as supplement to the integral I/O of the CPUs
- For flexible adaptation of the controller to the corresponding task
- For subsequent expansion of the system with additional inputs and outputs
- From +60 °C to +70 °C, max. 50% of the inputs can be controlled simultaneously

Note:

SIPLUS extreme products are based on SIMATIC standard products. The contents listed here were taken from the respective standard products. SIPLUS extreme-specific information was added.

Technical specifications

Article number	6AG1223-1BH32-2XB0	6AG1223-1BH32-4XB0	6AG1223-1PH32-2XB0	6AG1223-1PH32-4XB0
Based on	6ES7223-1BH32-0XB0 SIPLUS S7-1200 SM 1223 8DI/8DQ	6ES7223-1BH32-0XB0 SIPLUS S7-1200 SM 1223 8DI/8DQ	6ES7223-1PH32-0XB0 SIPLUS S7-1200 SM 1223 8DI/8DQ RLY	6ES7223-1PH32-0XB0 SIPLUS S7-1200 SM 1223 8DI/8DQ RLY
Ambient conditions				
Free fall				
• Fall height, max.	0.3 m; five times, in product package	0.3 m; five times, in product package	0.3 m; five times, in product package	0.3 m; five times, in product package
Ambient temperature during operation				
• min.	-40 °C; = Tmin (incl. condensation/frost); start-up @ -25 °C	-20 °C; = Tmin (incl. condensation/frost); start-up @ 0 °C	-40 °C; = Tmin (incl. condensation/frost); start-up @ -25 °C	-20 °C; = Tmin (incl. condensation/frost); start-up @ 0 °C
• max.	70 °C; = Tmax; Tmax > +60 °C number of simultaneously activated outputs 4, inputs 4 (no adjacent points) for horizontal mounting position	60 °C; = Tmax	70 °C; = Tmax; Tmax > +60 °C number of simultaneously activated outputs 4, inputs 4 (no adjacent points) for horizontal mounting position	60 °C; = Tmax
• At cold restart, min.	-25 °C	0 °C	-25 °C	0 °C
Altitude during operation relating to sea level				
• Installation altitude above sea level, max.	5 000 m	5 000 m	2 000 m	2 000 m
• Ambient air temperature-barometric pressure-altitude	Tmin ... Tmax at 1 140 hPa ... 795 hPa (-1 000 m ... +2 000 m) // Tmin ... (Tmax - 10 K) at 795 hPa ... 658 hPa (+2 000 m ... +3 500 m) // Tmin ... (Tmax -20 K) at 658 hPa ... 540 hPa (+3 500 m ... +5 000 m)	Tmin ... Tmax at 1 140 hPa ... 795 hPa (-1 000 m ... +2 000 m) // Tmin ... (Tmax - 10 K) at 795 hPa ... 658 hPa (+2 000 m ... +3 500 m) // Tmin ... (Tmax -20 K) at 658 hPa ... 540 hPa (+3 500 m ... +5 000 m)	Tmin ... Tmax at 1 140 hPa ... 795 hPa (-1 000 m ... +2 000 m) // Tmin ... (Tmax - 10 K) at 795 hPa ... 658 hPa (+2 000 m ... +3 500 m) // Tmin ... (Tmax - 20 K) at 658 hPa ... 540 hPa (+3 500 m ... +5 000 m); above 2 000 m max. 132 V AC	Tmin ... Tmax at 1 140 hPa ... 795 hPa (-1 000 m ... +2 000 m) // Tmin ... (Tmax - 10 K) at 795 hPa ... 658 hPa (+2 000 m ... +3 500 m) // Tmin ... (Tmax - 20 K) at 658 hPa ... 540 hPa (+3 500 m ... +5 000 m); above 2 000 m max. 132 V AC
Relative humidity				
• With condensation, tested in accordance with IEC 60068-2-38, max.	100 %; RH incl. condensation/frost (no commissioning under condensation conditions)	100 %; RH incl. condensation/frost (no commissioning under condensation conditions)	100 %; RH incl. condensation/frost (no commissioning under condensation conditions)	100 %; RH incl. condensation/frost (no commissioning under condensation conditions)
Resistance				
Coolants and lubricants				
- Resistant to commercially available coolants and lubricants	Yes	Yes	Yes	Yes

SIMATIC S7-1200 Basic Controllers

I/O modules

SIPLUS digital modules

SIPLUS SM 1223 digital input/output modules

Technical specifications

Article number	6AG1223-1BH32-2XB0	6AG1223-1BH32-4XB0	6AG1223-1PH32-2XB0	6AG1223-1PH32-4XB0
Based on	6ES7223-1BH32-0XB0 SIPLUS S7-1200 SM 1223 8DI/8DQ	6ES7223-1BH32-0XB0 SIPLUS S7-1200 SM 1223 8DI/8DQ	6ES7223-1PH32-0XB0 SIPLUS S7-1200 SM 1223 8DI/8DQ RLY	6ES7223-1PH32-0XB0 SIPLUS S7-1200 SM 1223 8DI/8DQ RLY
Use in stationary industrial systems				
- to biologically active substances according to EN 60721-3-3	Yes; Class 3B2 mold, fungus and dry rot spores (with the exception of fauna); Class 3B3 on request	Yes; Class 3B2 mold, fungus and dry rot spores (with the exception of fauna); Class 3B3 on request	Yes; Class 3B2 mold, fungus and dry rot spores (with the exception of fauna); Class 3B3 on request	Yes; Class 3B2 mold, fungus and dry rot spores (with the exception of fauna); Class 3B3 on request
- to chemically active substances according to EN 60721-3-3	Yes; Class 3C4 (RH < 75 %) incl. salt spray acc. to EN 60068-2-52 (severity degree 3); *	Yes; Class 3C4 (RH < 75 %) incl. salt spray acc. to EN 60068-2-52 (severity degree 3); *	Yes; Class 3C4 (RH < 75 %) incl. salt spray acc. to EN 60068-2-52 (severity degree 3); *	Yes; Class 3C4 (RH < 75 %) incl. salt spray acc. to EN 60068-2-52 (severity degree 3); *
- to mechanically active substances according to EN 60721-3-3	Yes; Class 3S4 incl. sand, dust; *	Yes; Class 3S4 incl. sand, dust; *	Yes; Class 3S4 incl. sand, dust; *	Yes; Class 3S4 incl. sand, dust; *
Use on ships/at sea				
- to biologically active substances according to EN 60721-3-6	Yes; Class 6B2 mold and fungal spores (excluding fauna); Class 6B3 on request	Yes; Class 6B2 mold and fungal spores (excluding fauna); Class 6B3 on request	Yes; Class 6B2 mold and fungal spores (excluding fauna); Class 6B3 on request	Yes; Class 6B2 mold and fungal spores (excluding fauna); Class 6B3 on request
- to chemically active substances according to EN 60721-3-6	Yes; Class 6C3 (RH < 75 %) incl. salt spray acc. to EN 60068-2-52 (severity degree 3); *	Yes; Class 6C3 (RH < 75 %) incl. salt spray acc. to EN 60068-2-52 (severity degree 3); *	Yes; Class 6C3 (RH < 75 %) incl. salt spray acc. to EN 60068-2-52 (severity degree 3); *	Yes; Class 6C3 (RH < 75 %) incl. salt spray acc. to EN 60068-2-52 (severity degree 3); *
- to mechanically active substances according to EN 60721-3-6	Yes; Class 6S3 incl. sand, dust; *	Yes; Class 6S3 incl. sand, dust; *	Yes; Class 6S3 incl. sand, dust; *	Yes; Class 6S3 incl. sand, dust; *
Usage in industrial process technology				
- Against chemically active substances acc. to EN 60654-4	Yes; Class 3 (excluding trichlorethylene)	Yes; Class 3 (excluding trichlorethylene)	Yes; Class 3 (excluding trichlorethylene)	Yes; Class 3 (excluding trichlorethylene)
- Environmental conditions for process, measuring and control systems acc. to ANSI/ISA-71.04	Yes; Level GX group A/B (excluding trichlorethylene; harmful gas concentrations up to the limits of EN 60721-3-3 class 3C4 permissible); level LC3 (salt spray) and level LB3 (oil)	Yes; Level GX group A/B (excluding trichlorethylene; harmful gas concentrations up to the limits of EN 60721-3-3 class 3C4 permissible); level LC3 (salt spray) and level LB3 (oil)	Yes; Level GX group A/B (excluding trichlorethylene; harmful gas concentrations up to the limits of EN 60721-3-3 class 3C4 permissible); level LC3 (salt spray) and level LB3 (oil)	Yes; Level GX group A/B (excluding trichlorethylene; harmful gas concentrations up to the limits of EN 60721-3-3 class 3C4 permissible); level LC3 (salt spray) and level LB3 (oil)
Remark				
- Note regarding classification of environmental conditions acc. to EN 60721, EN 60654-4 and ANSI/ISA-71.04	* The supplied plug covers must remain in place over the unused interfaces during operation!	* The supplied plug covers must remain in place over the unused interfaces during operation!	* The supplied plug covers must remain in place over the unused interfaces during operation!	* The supplied plug covers must remain in place over the unused interfaces during operation!
Conformal coating				
• Coatings for printed circuit board assemblies acc. to EN 61086	Yes; Class 2 for high availability	Yes; Class 2 for high availability	Yes; Class 2 for high availability	Yes; Class 2 for high availability
• Protection against fouling acc. to EN 60664-3	Yes; Type 1 protection	Yes; Type 1 protection	Yes; Type 1 protection	Yes; Type 1 protection
• Military testing according to MIL-I-46058C, Amendment 7	Yes; Discoloration of coating possible during service life	Yes; Discoloration of coating possible during service life	Yes; Discoloration of coating possible during service life	Yes; Discoloration of coating possible during service life
• Qualification and Performance of Electrical Insulating Compound for Printed Board Assemblies according to IPC-CC-830A	Yes; Conformal coating, Class A	Yes; Conformal coating, Class A	Yes; Conformal coating, Class A	Yes; Conformal coating, Class A

Technical specifications

Article number	6AG1223-1PL32-2XB0	6AG1223-1PL32-4XB0	6AG1223-1BL32-2XB0	6AG1223-1BL32-4XB0
Based on	6ES7223-1PL32-0XB0 SIPLUS S7-1200 SM 1223 16DI/16DQ RLY	6ES7223-1PL32-0XB0 SIPLUS S7-1200 SM 1223 16DI/16DQ RLY	6ES7223-1BL32-0XB0 SIPLUS S7-1200 SM 1223 16DI/16DQ	6ES7223-1BL32-0XB0 SIPLUS S7-1200 SM 1223 16DI/16DQ
Ambient conditions				
Free fall				
• Fall height, max.	0.3 m; five times, in product package	0.3 m; five times, in product package	0.3 m; five times, in product package	0.3 m; five times, in product package
Ambient temperature during operation				
• min.	-40 °C; = Tmin. (incl. condensation/frost); start-up @ -25 °C	-20 °C; = Tmin (incl. condensation/frost); start-up @ 0 °C	-40 °C; = Tmin (incl. condensation/frost); start-up @ -25 °C	-20 °C; = Tmin (incl. condensation/frost); start-up @ 0 °C
• max.	70 °C; = Tmax; Tmax > +60 °C number of simultaneously activated outputs 8, inputs 8 (no adjacent points) for horizontal mounting position	60 °C; = Tmax	70 °C; = Tmax; Tmax > +60 °C number of simultaneously activated outputs 8, inputs 8 (no adjacent points) for horizontal mounting position	60 °C; = Tmax
• At cold restart, min.	-25 °C	0 °C	-25 °C	0 °C
Altitude during operation relating to sea level				
• Installation altitude above sea level, max.	2 000 m	2 000 m	5 000 m	5 000 m
• Ambient air temperature-barometric pressure-altitude	Tmin ... Tmax at 1 140 hPa ... 795 hPa (-1 000 m ... +2 000 m) // Tmin ... (Tmax - 10 K) at 795 hPa ... 658 hPa (+2 000 m ... +3 500 m) // Tmin ... (Tmax - 20 K) at 658 hPa ... 540 hPa (+3 500 m ... +5 000 m); above 2 000 m max. 132 V AC	Tmin ... Tmax at 1 140 hPa ... 795 hPa (-1 000 m ... +2 000 m) // Tmin ... (Tmax - 10 K) at 795 hPa ... 658 hPa (+2 000 m ... +3 500 m) // Tmin ... (Tmax - 20 K) at 658 hPa ... 540 hPa (+3 500 m ... +5 000 m); above 2 000 m max. 132 V AC	Tmin ... Tmax at 1 140 hPa ... 795 hPa (-1 000 m ... +2 000 m) // Tmin ... (Tmax - 10 K) at 795 hPa ... 658 hPa (+2 000 m ... +3 500 m) // Tmin ... (Tmax - 20 K) at 658 hPa ... 540 hPa (+3 500 m ... +5 000 m)	Tmin ... Tmax at 1 140 hPa ... 795 hPa (-1 000 m ... +2 000 m) // Tmin ... (Tmax - 10 K) at 795 hPa ... 658 hPa (+2 000 m ... +3 500 m) // Tmin ... (Tmax - 20 K) at 658 hPa ... 540 hPa (+3 500 m ... +5 000 m)
Relative humidity				
• With condensation, tested in accordance with IEC 60068-2-38, max.	100 %; RH incl. condensation/frost (no commissioning under condensation conditions)	100 %; RH incl. condensation/frost (no commissioning under condensation conditions)	100 %; RH incl. condensation/frost (no commissioning under condensation conditions)	100 %; RH incl. condensation/frost (no commissioning under condensation conditions)
Resistance				
Coolants and lubricants				
- Resistant to commercially available coolants and lubricants	Yes	Yes	Yes	Yes
Use in stationary industrial systems				
- to biologically active substances according to EN 60721-3-3	Yes; Class 3B2 mold, fungus and dry rot spores (with the exception of fauna); Class 3B3 on request	Yes; Class 3B2 mold, fungus and dry rot spores (with the exception of fauna); Class 3B3 on request	Yes; Class 3B2 mold, fungus and dry rot spores (with the exception of fauna); Class 3B3 on request	Yes; Class 3B2 mold, fungus and dry rot spores (with the exception of fauna); Class 3B3 on request
- to chemically active substances according to EN 60721-3-3	Yes; Class 3C4 (RH < 75 %) incl. salt spray acc. to EN 60068-2-52 (severity degree 3); *	Yes; Class 3C4 (RH < 75 %) incl. salt spray acc. to EN 60068-2-52 (severity degree 3); *	Yes; Class 3C4 (RH < 75 %) incl. salt spray acc. to EN 60068-2-52 (severity degree 3); *	Yes; Class 3C4 (RH < 75 %) incl. salt spray acc. to EN 60068-2-52 (severity degree 3); *
- to mechanically active substances according to EN 60721-3-3	Yes; Class 3S4 incl. sand, dust; *	Yes; Class 3S4 incl. sand, dust; *	Yes; Class 3S4 incl. sand, dust; *	Yes; Class 3S4 incl. sand, dust; *
Use on ships/at sea				
- to biologically active substances according to EN 60721-3-6	Yes; Class 6B2 mold and fungal spores (excluding fauna); Class 6B3 on request	Yes; Class 6B2 mold and fungal spores (excluding fauna); Class 6B3 on request	Yes; Class 6B2 mold and fungal spores (excluding fauna); Class 6B3 on request	Yes; Class 6B2 mold and fungal spores (excluding fauna); Class 6B3 on request
- to chemically active substances according to EN 60721-3-6	Yes; Class 6C3 (RH < 75 %) incl. salt spray acc. to EN 60068-2-52 (severity degree 3); *	Yes; Class 6C3 (RH < 75 %) incl. salt spray acc. to EN 60068-2-52 (severity degree 3); *	Yes; Class 6C3 (RH < 75 %) incl. salt spray acc. to EN 60068-2-52 (severity degree 3); *	Yes; Class 6C3 (RH < 75 %) incl. salt spray acc. to EN 60068-2-52 (severity degree 3); *
- to mechanically active substances according to EN 60721-3-6	Yes; Class 6S3 incl. sand, dust; *	Yes; Class 6S3 incl. sand, dust; *	Yes; Class 6S3 incl. sand, dust; *	Yes; Class 6S3 incl. sand, dust; *

SIMATIC S7-1200 Basic Controllers

I/O modules

SIPLUS digital modules

SIPLUS SM 1223 digital input/output modules

Technical specifications

Article number	6AG1223-1PL32-2XB0	6AG1223-1PL32-4XB0	6AG1223-1BL32-2XB0	6AG1223-1BL32-4XB0
Based on	6ES7223-1PL32-0XB0 SIPLUS S7-1200 SM 1223 16DI/16DQ RLY	6ES7223-1PL32-0XB0 SIPLUS S7-1200 SM 1223 16DI/16DQ RLY	6ES7223-1BL32-0XB0 SIPLUS S7-1200 SM 1223 16DI/16DQ	6ES7223-1BL32-0XB0 SIPLUS S7-1200 SM 1223 16DI/16DQ
Usage in industrial process technology				
<ul style="list-style-type: none"> - Against chemically active substances acc. to EN 60654-4 - Environmental conditions for process, measuring and control systems acc. to ANSI/ISA-71.04 	Yes; Class 3 (excluding trichlorethylene) Yes; Level GX group A/B (excluding trichlorethylene; harmful gas concentrations up to the limits of EN 60721-3-3 class 3C4 permissible); level LC3 (salt spray) and level LB3 (oil)	Yes; Class 3 (excluding trichlorethylene) Yes; Level GX group A/B (excluding trichlorethylene; harmful gas concentrations up to the limits of EN 60721-3-3 class 3C4 permissible); level LC3 (salt spray) and level LB3 (oil)	Yes; Class 3 (excluding trichlorethylene) Yes; Level GX group A/B (excluding trichlorethylene; harmful gas concentrations up to the limits of EN 60721-3-3 class 3C4 permissible); level LC3 (salt spray) and level LB3 (oil)	Yes; Class 3 (excluding trichlorethylene) Yes; Level GX group A/B (excluding trichlorethylene; harmful gas concentrations up to the limits of EN 60721-3-3 class 3C4 permissible); level LC3 (salt spray) and level LB3 (oil)
Remark				
<ul style="list-style-type: none"> - Note regarding classification of environmental conditions acc. to EN 60721, EN 60654-4 and ANSI/ISA-71.04 	* The supplied plug covers must remain in place over the unused interfaces during operation!	* The supplied plug covers must remain in place over the unused interfaces during operation!	* The supplied plug covers must remain in place over the unused interfaces during operation!	* The supplied plug covers must remain in place over the unused interfaces during operation!
Conformal coating				
<ul style="list-style-type: none"> • Coatings for printed circuit board assemblies acc. to EN 61086 • Protection against fouling acc. to EN 60664-3 • Military testing according to MIL-I-46058C, Amendment 7 • Qualification and Performance of Electrical Insulating Compound for Printed Board Assemblies according to IPC-CC-830A 	Yes; Class 2 for high availability Yes; Type 1 protection Yes; Discoloration of coating possible during service life Yes; Conformal coating, Class A	Yes; Class 2 for high availability Yes; Type 1 protection Yes; Discoloration of coating possible during service life Yes; Conformal coating, Class A	Yes; Class 2 for high availability Yes; Type 1 protection Yes; Discoloration of coating possible during service life Yes; Conformal coating, Class A	Yes; Class 2 for high availability Yes; Type 1 protection Yes; Discoloration of coating possible during service life Yes; Conformal coating, Class A
Article number	6AG1223-1QH32-2XB0		6AG1223-1QH32-4XB0	
Based on	6ES7223-1QH32-0XB0 SIPLUS S7-1200 SM 1223 8DI AC/8DQ RLY		6ES7223-1QH32-0XB0 SIPLUS S7-1200 SM 1223 8DI AC/8DQ RLY	
Ambient conditions				
Ambient temperature during operation				
<ul style="list-style-type: none"> • min. • max. 	-40 °C; = Tmin (incl. condensation/frost); start-up @ -25 °C 70 °C; = Tmax; Tmax > +60 °C number of simultaneously activated outputs 4, inputs 4 (no adjacent points) for horizontal mounting position		-20 °C; = Tmin (incl. condensation/frost); start-up @ 0 °C 60 °C; = Tmax	
Altitude during operation relating to sea level				
<ul style="list-style-type: none"> • Installation altitude above sea level, max. • Ambient air temperature-barometric pressure-altitude 	5 000 m Tmin ... Tmax at 1 080 hPa ... 795 hPa (-1 000 m ... +2 000 m) // Tmin ... (Tmax - 10 K) at 795 hPa ... 658 hPa (+2 000 m ... +3 500 m) // Tmin ... (Tmax - 20 K) at 658 hPa ... 540 hPa (+3 500 m ... +5 000 m)		Tmin ... Tmax at 1 080 hPa ... 795 hPa (-1 000 m ... +2 000 m) // Tmin ... (Tmax - 10 K) at 795 hPa ... 658 hPa (+2 000 m ... +3 500 m) // Tmin ... (Tmax - 20 K) at 658 hPa ... 540 hPa (+3 500 m ... +5 000 m)	
Relative humidity				
<ul style="list-style-type: none"> • With condensation, tested in accordance with IEC 60068-2-38, max. 	100 %; RH incl. condensation/frost (no commissioning under condensation conditions)		100 %; RH incl. condensation/frost (no commissioning under condensation conditions)	
Resistance				
Coolants and lubricants				
<ul style="list-style-type: none"> - Resistant to commercially available coolants and lubricants 	Yes; Incl. diesel and oil droplets in the air		Yes; Incl. diesel and oil droplets in the air	
Use in stationary industrial systems				
<ul style="list-style-type: none"> - to biologically active substances according to EN 60721-3-3 - to chemically active substances according to EN 60721-3-3 - to mechanically active substances according to EN 60721-3-3 	Yes; Class 3B2 mold, fungus and dry rot spores (with the exception of fauna); Class 3B3 on request Yes; Class 3C4 (RH < 75 %) incl. salt spray acc. to EN 60068-2-52 (severity degree 3); * Yes; Class 3S4 incl. sand, dust, *		Yes; Class 3B2 mold, fungus and dry rot spores (with the exception of fauna); Class 3B3 on request Yes; Class 3C4 (RH < 75 %) incl. salt spray acc. to EN 60068-2-52 (severity degree 3); * Yes; Class 3S4 incl. sand, dust, *	

Technical specifications

Article number	6AG1223-1QH32-2XB0	6AG1223-1QH32-4XB0
Based on	6ES7223-1QH32-0XB0 SIPLUS S7-1200 SM 1223 8DI AC/8DQ RLY	6ES7223-1QH32-0XB0 SIPLUS S7-1200 SM 1223 8DI AC/8DQ RLY
Use on ships/at sea		
- to biologically active substances according to EN 60721-3-6	Yes; Class 6B2 mold and fungal spores (excluding fauna); Class 6B3 on request	Yes; Class 6B2 mold and fungal spores (excluding fauna); Class 6B3 on request
- to chemically active substances according to EN 60721-3-6	Yes; Class 6C3 (RH < 75 %) incl. salt spray acc. to EN 60068-2-52 (severity degree 3); *	Yes; Class 6C3 (RH < 75 %) incl. salt spray acc. to EN 60068-2-52 (severity degree 3); *
- to mechanically active substances according to EN 60721-3-6	Yes; Class 6S3 incl. sand, dust; *	Yes; Class 6S3 incl. sand, dust; *
Usage in industrial process technology		
- Against chemically active substances acc. to EN 60654-4	Yes; Class 3 (excluding trichlorethylene)	Yes; Class 3 (excluding trichlorethylene)
- Environmental conditions for process, measuring and control systems acc. to ANSI/ISA-71.04	Yes; Level GX group A/B (excluding trichlorethylene; harmful gas concentrations up to the limits of EN 60721-3-3 class 3C4 permissible); level LC3 (salt spray) and level LB3 (oil)	Yes; Level GX group A/B (excluding trichlorethylene; harmful gas concentrations up to the limits of EN 60721-3-3 class 3C4 permissible); level LC3 (salt spray) and level LB3 (oil)
Remark		
- Note regarding classification of environmental conditions acc. to EN 60721, EN 60654-4 and ANSI/ISA-71.04	* The supplied plug covers must remain in place over the unused interfaces during operation!	* The supplied plug covers must remain in place over the unused interfaces during operation!
Conformal coating		
• Coatings for printed circuit board assemblies acc. to EN 61086	Yes; Class 2 for high availability	Yes; Class 2 for high availability
• Protection against fouling acc. to EN 60664-3	Yes; Type 1 protection	Yes; Type 1 protection
• Military testing according to MIL-I-46058C, Amendment 7	Yes; Discoloration of coating possible during service life	Yes; Discoloration of coating possible during service life
• Qualification and Performance of Electrical Insulating Compound for Printed Board Assemblies according to IPC-CC-830A	Yes; Conformal coating, Class A	Yes; Conformal coating, Class A

SIMATIC S7-1200 Basic Controllers

I/O modules

SIPLUS digital modules

SIPLUS SM 1223 digital input/output modules

Ordering data	Article No.
SIPLUS SM 1223 digital input/output signal module (Extended temperature range and exposure to media)	
8 inputs, 24 V DC, IEC type 1 current sinking; 8 x 24 V DC transistor outputs, 0.5 A, 5 W <ul style="list-style-type: none"> For areas with exceptional exposure to media (conformal coating) 	6AG1223-1BH32-4XB0
<ul style="list-style-type: none"> -25 ... +70 °C, from +60 ... +70 °C number of simultaneously controllable inputs and outputs max. 50 % 	6AG1223-1BH32-2XB0
16 inputs, 24 V DC, IEC type 1 current sinking; 16 x 24 V DC transistor outputs, 0.5 A, 5 W <ul style="list-style-type: none"> For areas with exceptional exposure to media (conformal coating) 	6AG1223-1BL32-4XB0
<ul style="list-style-type: none"> -25 ... +70 °C, from +60 ... +70 °C number of simultaneously controllable inputs and outputs max. 50 % 	6AG1223-1BL32-2XB0
8 inputs, 24 V DC, IEC type 1 current sinking; 8 relay outputs, 5 ... 30 V DC / 5 ... 250 V AC, 2 A, 30 W DC / 200 W AC <ul style="list-style-type: none"> For areas with exceptional exposure to media (conformal coating) 	6AG1223-1PH32-4XB0
<ul style="list-style-type: none"> -25 ... +70 °C, from +60 ... +70 °C number of simultaneously controllable inputs and outputs max. 50 % 	6AG1223-1PH32-2XB0
16 inputs, 24 V DC, IEC type 1 current sinking; 16 relay outputs, 5 ... 30 V DC / 5 ... 250 V AC, 2 A, 30 W DC / 200 W AC <ul style="list-style-type: none"> For areas with exceptional exposure to media (conformal coating) 	6AG1223-1PL32-4XB0
<ul style="list-style-type: none"> -25 ... +70 °C, from +60 ... +70 °C number of simultaneously controllable inputs and outputs max. 50 % 	6AG1223-1PL32-2XB0
8 inputs, 120/230 V AC; 8 relay outputs, 5 ... 30 V DC/5 ... 250 V AC, 2 A, 30 W DC/200 W AC <ul style="list-style-type: none"> For areas with exceptional exposure to media (conformal coating) 	6AG1223-1QH32-4XB0
-40 ... +70 °C, from +60 ... +70 °C number of simultaneously controllable inputs and outputs max. 50%	6AG1223-1QH32-2XB0
Accessories	See SIMATIC S7-1200 SM 1223 digital input/output modules, page 3/8

Overview



- Analog inputs for SIPLUS S7-1200
- With extremely short conversion times
- For connecting analog actuators and sensors without additional amplifiers
- Even solves more complex automation tasks
- From +60 °C to +70 °C, max. 50% of the inputs can be controlled simultaneously

Note:

SIPLUS extreme products are based on SIMATIC standard products. The contents listed here were taken from the respective standard products. SIPLUS extreme-specific information was added.

Technical specifications

Article number	6AG1231-4HD32-4XB0	6AG1231-4HF32-4XB0	6AG1231-5ND32-4XB0
Based on	6ES7231-4HD32-0XB0	6ES7231-4HF32-0XB0	6ES7231-5ND32-0XB0
	SIPLUS S7-1200 SM 1231 4AI 13Bit	SIPLUS S7-1200 SM 1231 8AI 13Bit	SIPLUS S7-1200 SM 1231 4AI 16Bit
Ambient conditions			
Free fall			
• Fall height, max.	0.3 m; five times, in product package	0.3 m; five times, in product package	0.3 m; five times, in product package
Ambient temperature during operation			
• min.	-20 °C; = Tmin (incl. condensation/frost); start-up @ 0 °C	-20 °C; = Tmin (incl. condensation/frost); start-up @ 0 °C	-20 °C; = Tmin (incl. condensation/frost); start-up @ 0 °C
• max.	60 °C; = Tmax	60 °C; = Tmax	60 °C; = Tmax
Altitude during operation relating to sea level			
• Installation altitude above sea level, max.	5 000 m	5 000 m	5 000 m
• Ambient air temperature-barometric pressure-altitude	Tmin ... Tmax at 1 140 hPa ... 795 hPa (-1 000 m ... +2 000 m) // Tmin ... (Tmax - 10 K) at 795 hPa ... 658 hPa (+2 000 m ... +3 500 m) // Tmin ... (Tmax -20 K) at 658 hPa ... 540 hPa (+3 500 m ... +5 000 m)	Tmin ... Tmax at 1 140 hPa ... 795 hPa (-1 000 m ... +2 000 m) // Tmin ... (Tmax - 10 K) at 795 hPa ... 658 hPa (+2 000 m ... +3 500 m) // Tmin ... (Tmax -20 K) at 658 hPa ... 540 hPa (+3 500 m ... +5 000 m)	Tmin ... Tmax at 1 140 hPa ... 795 hPa (-1 000 m ... +2 000 m) // Tmin ... (Tmax - 10 K) at 795 hPa ... 658 hPa (+2 000 m ... +3 500 m) // Tmin ... (Tmax -20 K) at 658 hPa ... 540 hPa (+3 500 m ... +5 000 m)
Relative humidity			
• With condensation, tested in accordance with IEC 60068-2-38, max.	100 %; RH incl. condensation/frost (no commissioning under condensation conditions)	100 %; RH incl. condensation/frost (no commissioning under condensation conditions)	100 %; RH incl. condensation/frost (no commissioning under condensation conditions)
Resistance			
Coolants and lubricants			
- Resistant to commercially available coolants and lubricants	Yes; Incl. diesel and oil droplets in the air	Yes; Incl. diesel and oil droplets in the air	Yes; Incl. diesel and oil droplets in the air
Use in stationary industrial systems			
- to biologically active substances according to EN 60721-3-3	Yes; Class 3B2 mold, fungus and dry rot spores (with the exception of fauna); Class 3B3 on request	Yes; Class 3B2 mold, fungus and dry rot spores (with the exception of fauna); Class 3B3 on request	Yes; Class 3B2 mold, fungus and dry rot spores (with the exception of fauna); Class 3B3 on request
- to chemically active substances according to EN 60721-3-3	Yes; Class 3C4 (RH < 75 %) incl. salt spray acc. to EN 60068-2-52 (severity degree 3); *	Yes; Class 3C4 (RH < 75 %) incl. salt spray acc. to EN 60068-2-52 (severity degree 3); *	Yes; Class 3C4 (RH < 75 %) incl. salt spray acc. to EN 60068-2-52 (severity degree 3); *
- to mechanically active substances according to EN 60721-3-3	Yes; Class 3S4 incl. sand, dust, *	Yes; Class 3S4 incl. sand, dust, *	Yes; Class 3S4 incl. sand, dust, *

SIMATIC S7-1200 Basic Controllers

I/O modules

SIPLUS analog modules

SIPLUS SM 1231 analog input modules

Technical specifications

Article number	6AG1231-4HD32-4XB0	6AG1231-4HF32-4XB0	6AG1231-5ND32-4XB0
Based on	6ES7231-4HD32-0XB0	6ES7231-4HF32-0XB0	6ES7231-5ND32-0XB0
	SIPLUS S7-1200 SM 1231 4AI 13Bit	SIPLUS S7-1200 SM 1231 8AI 13Bit	SIPLUS S7-1200 SM 1231 4AI 16Bit
Use on ships/at sea			
- to biologically active substances according to EN 60721-3-6	Yes; Class 6B2 mold and fungal spores (excluding fauna); Class 6B3 on request	Yes; Class 6B2 mold and fungal spores (excluding fauna); Class 6B3 on request	Yes; Class 6B2 mold and fungal spores (excluding fauna); Class 6B3 on request
- to chemically active substances according to EN 60721-3-6	Yes; Class 6C3 (RH < 75 %) incl. salt spray acc. to EN 60068-2-52 (severity degree 3); *	Yes; Class 6C3 (RH < 75 %) incl. salt spray acc. to EN 60068-2-52 (severity degree 3); *	Yes; Class 6C3 (RH < 75 %) incl. salt spray acc. to EN 60068-2-52 (severity degree 3); *
- to mechanically active substances according to EN 60721-3-6	Yes; Class 6S3 incl. sand, dust; *	Yes; Class 6S3 incl. sand, dust; *	Yes; Class 6S3 incl. sand, dust; *
Usage in industrial process technology			
- Against chemically active substances acc. to EN 60654-4	Yes; Class 3 (excluding trichlorethylene)	Yes; Class 3 (excluding trichlorethylene)	Yes; Class 3 (excluding trichlorethylene)
- Environmental conditions for process, measuring and control systems acc. to ANSI/ISA-71.04	Yes; Level GX group A/B (excluding trichlorethylene; harmful gas concentrations up to the limits of EN 60721-3-3 class 3C4 permissible); level LC3 (salt spray) and level LB3 (oil)	Yes; Level GX group A/B (excluding trichlorethylene; harmful gas concentrations up to the limits of EN 60721-3-3 class 3C4 permissible); level LC3 (salt spray) and level LB3 (oil)	Yes; Level GX group A/B (excluding trichlorethylene; harmful gas concentrations up to the limits of EN 60721-3-3 class 3C4 permissible); level LC3 (salt spray) and level LB3 (oil)
Remark			
- Note regarding classification of environmental conditions acc. to EN 60721, EN 60654-4 and ANSI/ISA-71.04	* The supplied plug covers must remain in place over the unused interfaces during operation!	* The supplied plug covers must remain in place over the unused interfaces during operation!	* The supplied plug covers must remain in place over the unused interfaces during operation!
Conformal coating			
• Coatings for printed circuit board assemblies acc. to EN 61086	Yes; Class 2 for high availability	Yes; Class 2 for high availability	Yes; Class 2 for high availability
• Protection against fouling acc. to EN 60664-3	Yes; Type 1 protection	Yes; Type 1 protection	Yes; Type 1 protection
• Military testing according to MIL-I-46058C, Amendment 7	Yes; Discoloration of coating possible during service life	Yes; Discoloration of coating possible during service life	Yes; Discoloration of coating possible during service life
• Qualification and Performance of Electrical Insulating Compound for Printed Board Assemblies according to IPC-CC-830A	Yes; Conformal coating, Class A	Yes; Conformal coating, Class A	Yes; Conformal coating, Class A

Ordering data

Article No.

SIPLUS SM 1231 analog input signal module

(Extended temperature range and exposure to media)

Ambient temperature range
0 ... +55 °C

4 analog inputs, ±10 V, ±5 V, ±2.5 V, or 0 ... 20 mA, 16-bit

6AG1231-5ND32-4XB0

4 analog inputs ±10 V, ±5 V, ±2.5 V, or 0 ... 20 mA; 12-bit + sign

6AG1231-4HD32-4XB0

8 analog inputs, ±10 V, ±5 V, ±2.5 V, or 0 ... 20 mA, 12-bit + sign

6AG1231-4HF32-4XB0

Accessories

See SIMATIC S7-1200 SM 1231 analog input modules, catalog ST 70 · 2019, page 3/86

Overview



- Analog outputs for SIPLUS S7-1200
- With extremely short conversion times
- For connecting analog actuators without additional amplifiers
- Even solves more complex automation tasks
- From +60 °C to +70 °C, max. 50% of the outputs can be controlled simultaneously

Note:

SIPLUS extreme products are based on SIMATIC standard products. The contents listed here were taken from the respective standard products. SIPLUS extreme-specific information was added.

Technical specifications

Article number	6AG1232-4HB32-4XB0	6AG1232-4HD32-2XB0	6AG1232-4HD32-4XB0
Based on	6ES7232-4HB32-0XB0	6ES7232-4HD32-0XB0	6ES7232-4HD32-0XB0
	SIPLUS S7-1200 SM 1232 2AQ 13Bit	SIPLUS S7-1200 SM 1232 4AQ 14Bit	SIPLUS S7-1200 SM 1232 4AQ 14Bit
Ambient conditions			
Free fall			
• Fall height, max.	0.3 m; five times, in product package	0.3 m; five times, in product package	0.3 m; five times, in product package
Ambient temperature during operation			
• min.	-20 °C; = Tmin (incl. condensation/frost); start-up @ 0 °C	-40 °C; = Tmin (incl. condensation/frost); start-up @ -25 °C	-20 °C; = Tmin (incl. condensation/frost); start-up @ 0 °C
• max.	60 °C; = Tmax	70 °C; = Tmax	60 °C; = Tmax
Altitude during operation relating to sea level			
• Installation altitude above sea level, max.	5 000 m	5 000 m	5 000 m
• Ambient air temperature-barometric pressure-altitude	Tmin ... Tmax at 1 140 hPa ... 795 hPa (-1 000 m ... +2 000 m) // Tmin ... (Tmax - 10 K) at 795 hPa ... 658 hPa (+2 000 m ... +3 500 m) // Tmin ... (Tmax -20 K) at 658 hPa ... 540 hPa (+3 500 m ... +5 000 m)	Tmin ... Tmax at 1 140 hPa ... 795 hPa (-1 000 m ... +2 000 m) // Tmin ... (Tmax - 10 K) at 795 hPa ... 658 hPa (+2 000 m ... +3 500 m) // Tmin ... (Tmax -20 K) at 658 hPa ... 540 hPa (+3 500 m ... +5 000 m)	Tmin ... Tmax at 1 140 hPa ... 795 hPa (-1 000 m ... +2 000 m) // Tmin ... (Tmax - 10 K) at 795 hPa ... 658 hPa (+2 000 m ... +3 500 m) // Tmin ... (Tmax -20 K) at 658 hPa ... 540 hPa (+3 500 m ... +5 000 m)
Relative humidity			
• With condensation, tested in accordance with IEC 60068-2-38, max.	100 %; RH incl. condensation/frost (no commissioning under condensation conditions)	100 %; RH incl. condensation/frost (no commissioning under condensation conditions)	100 %; RH incl. condensation/frost (no commissioning under condensation conditions)
Resistance			
Coolants and lubricants			
- Resistant to commercially available coolants and lubricants	Yes; Incl. diesel and oil droplets in the air	Yes; Incl. diesel and oil droplets in the air	Yes; Incl. diesel and oil droplets in the air
Use in stationary industrial systems			
- to biologically active substances according to EN 60721-3-3	Yes; Class 3B2 mold, fungus and dry rot spores (with the exception of fauna); Class 3B3 on request	Yes; Class 3B2 mold, fungus and dry rot spores (with the exception of fauna); Class 3B3 on request	Yes; Class 3B2 mold, fungus and dry rot spores (with the exception of fauna); Class 3B3 on request
- to chemically active substances according to EN 60721-3-3	Yes; Class 3C4 (RH < 75 %) incl. salt spray acc. to EN 60068-2-52 (severity degree 3); *	Yes; Class 3C4 (RH < 75 %) incl. salt spray acc. to EN 60068-2-52 (severity degree 3); *	Yes; Class 3C4 (RH < 75 %) incl. salt spray acc. to EN 60068-2-52 (severity degree 3); *
- to mechanically active substances according to EN 60721-3-3	Yes; Class 3S4 incl. sand, dust, *	Yes; Class 3S4 incl. sand, dust, *	Yes; Class 3S4 incl. sand, dust, *

SIMATIC S7-1200 Basic Controllers

I/O modules

SIPLUS analog modules

SIPLUS SM 1232 analog output modules

Technical specifications

Article number	6AG1232-4HB32-4XB0	6AG1232-4HD32-2XB0	6AG1232-4HD32-4XB0
Based on	6ES7232-4HB32-0XB0	6ES7232-4HD32-0XB0	6ES7232-4HD32-0XB0
	SIPLUS S7-1200 SM 1232 2AQ 13Bit	SIPLUS S7-1200 SM 1232 4AQ 14Bit	SIPLUS S7-1200 SM 1232 4AQ 14Bit
Use on ships/at sea			
- to biologically active substances according to EN 60721-3-6	Yes; Class 6B2 mold and fungal spores (excluding fauna); Class 6B3 on request	Yes; Class 6B2 mold and fungal spores (excluding fauna); Class 6B3 on request	Yes; Class 6B2 mold and fungal spores (excluding fauna); Class 6B3 on request
- to chemically active substances according to EN 60721-3-6	Yes; Class 6C3 (RH < 75 %) incl. salt spray acc. to EN 60068-2-52 (severity degree 3); *	Yes; Class 6C3 (RH < 75 %) incl. salt spray acc. to EN 60068-2-52 (severity degree 3); *	Yes; Class 6C3 (RH < 75 %) incl. salt spray acc. to EN 60068-2-52 (severity degree 3); *
- to mechanically active substances according to EN 60721-3-6	Yes; Class 6S3 incl. sand, dust; *	Yes; Class 6S3 incl. sand, dust; *	Yes; Class 6S3 incl. sand, dust; *
Usage in industrial process technology			
- Against chemically active substances acc. to EN 60654-4	Yes; Class 3 (excluding trichlorethylene)	Yes; Class 3 (excluding trichlorethylene)	Yes; Class 3 (excluding trichlorethylene)
- Environmental conditions for process, measuring and control systems acc. to ANSI/ISA-71.04	Yes; Level GX group A/B (excluding trichlorethylene; harmful gas concentrations up to the limits of EN 60721-3-3 class 3C4 permissible); level LC3 (salt spray) and level LB3 (oil)	Yes; Level GX group A/B (excluding trichlorethylene; harmful gas concentrations up to the limits of EN 60721-3-3 class 3C4 permissible); level LC3 (salt spray) and level LB3 (oil)	Yes; Level GX group A/B (excluding trichlorethylene; harmful gas concentrations up to the limits of EN 60721-3-3 class 3C4 permissible); level LC3 (salt spray) and level LB3 (oil)
Remark			
- Note regarding classification of environmental conditions acc. to EN 60721, EN 60654-4 and ANSI/ISA-71.04	* The supplied plug covers must remain in place over the unused interfaces during operation!	* The supplied plug covers must remain in place over the unused interfaces during operation!	* The supplied plug covers must remain in place over the unused interfaces during operation!
Conformal coating			
• Coatings for printed circuit board assemblies acc. to EN 61086	Yes; Class 2 for high availability	Yes; Class 2 for high availability	Yes; Class 2 for high availability
• Protection against fouling acc. to EN 60664-3	Yes; Type 1 protection	Yes; Type 1 protection	Yes; Type 1 protection
• Military testing according to MIL-I-46058C, Amendment 7	Yes; Discoloration of coating possible during service life	Yes; Discoloration of coating possible during service life	Yes; Discoloration of coating possible during service life
• Qualification and Performance of Electrical Insulating Compound for Printed Board Assemblies according to IPC-CC-830A	Yes; Conformal coating, Class A	Yes; Conformal coating, Class A	Yes; Conformal coating, Class A

Ordering data

Article No.

SIPLUS SM 1232 analog output signal module

(Extended temperature range and exposure to media)

Ambient temperature range
-20 ... +60 °C

2 analog outputs, ±10 V with 14-bit or 0 ... 20 mA with 13-bit

6AG1232-4HB32-4XB0

4 analog outputs, ±10 V with 14-bit or 0 ... 20 mA with 13-bit

6AG1232-4HD32-4XB0

Ambient temperature range
-40 ... +70 °C

4 analog outputs, ±10 V with 14-bit or 0 ... 20 mA with 13-bit

6AG1232-4HD32-2XB0

Accessories

See SIMATIC S7-1200 SM 1232 analog output modules, catalog ST 70 · 2019, page 3/90

Overview



- Module for connecting up to 4 IO-Link devices according to IO Link Specification V1.1. The IO-Link parameters are configured using the Port Configuration Tool (PCT), version V3.2 and higher.

Note:

SIPLUS extreme products are based on SIMATIC standard products. The contents listed here were taken from the respective standard products. SIPLUS extreme-specific information was added.

3

Technical specifications

Article number	6AG1278-4BD32-2XB0	6AG1278-4BD32-4XB0
Based on	6ES7278-4BD32-0XB0 SIPLUS S7-1200 SM 1278 IO-Link Master	6ES7278-4BD32-0XB0 SIPLUS S7-1200 SM 1278 IO-Link Master
Ambient conditions		
Free fall		
• Fall height, max.	0.3 m; five times, in product package	0.3 m; five times, in product package
Ambient temperature during operation		
• min.	-40 °C; = Tmin (incl. condensation/frost); start-up @ -25 °C	-20 °C; = Tmin (incl. condensation/frost); start-up @ 0 °C
• max.	70 °C; = Tmax	60 °C; = Tmax
• At cold restart, min.	-25 °C	0 °C
Altitude during operation relating to sea level		
• Installation altitude above sea level, max.	5 000 m	5 000 m
• Ambient air temperature-barometric pressure-altitude	Tmin ... Tmax at 1 140 hPa ... 795 hPa (-1 000 m ... +2 000 m) // Tmin ... (Tmax - 10 K) at 795 hPa ... 658 hPa (+2 000 m ... +3 500 m) // Tmin ... (Tmax -20 K) at 658 hPa ... 540 hPa (+3 500 m ... +5 000 m)	Tmin ... Tmax at 1 140 hPa ... 795 hPa (-1 000 m ... +2 000 m) // Tmin ... (Tmax - 10 K) at 795 hPa ... 658 hPa (+2 000 m ... +3 500 m) // Tmin ... (Tmax -20 K) at 658 hPa ... 540 hPa (+3 500 m ... +5 000 m)
Relative humidity		
• With condensation, tested in accordance with IEC 60068-2-38, max.	100 %; RH incl. condensation/frost (no commissioning under condensation conditions)	100 %; RH incl. condensation/frost (no commissioning under condensation conditions)
Resistance		
Coolants and lubricants		
- Resistant to commercially available coolants and lubricants	Yes; Incl. diesel and oil droplets in the air	Yes; Incl. diesel and oil droplets in the air
Use in stationary industrial systems		
- to biologically active substances according to EN 60721-3-3	Yes; Class 3B2 mold, fungus and dry rot spores (with the exception of fauna); Class 3B3 on request	Yes; Class 3B2 mold, fungus and dry rot spores (with the exception of fauna); Class 3B3 on request
- to chemically active substances according to EN 60721-3-3	Yes; Class 3C4 (RH < 75 %) incl. salt spray acc. to EN 60068-2-52 (severity degree 3); *	Yes; Class 3C4 (RH < 75 %) incl. salt spray acc. to EN 60068-2-52 (severity degree 3); *
- to mechanically active substances according to EN 60721-3-3	Yes; Class 3S4 incl. sand, dust, *	Yes; Class 3S4 incl. sand, dust, *
Use on ships/at sea		
- to biologically active substances according to EN 60721-3-6	Yes; Class 6B2 mold and fungal spores (excluding fauna); Class 6B3 on request	Yes; Class 6B2 mold and fungal spores (excluding fauna); Class 6B3 on request
- to chemically active substances according to EN 60721-3-6	Yes; Class 6C3 (RH < 75 %) incl. salt spray acc. to EN 60068-2-52 (severity degree 3); *	Yes; Class 6C3 (RH < 75 %) incl. salt spray acc. to EN 60068-2-52 (severity degree 3); *
- to mechanically active substances according to EN 60721-3-6	Yes; Class 6S3 incl. sand, dust; *	Yes; Class 6S3 incl. sand, dust; *

SIMATIC S7-1200 Basic Controllers

I/O modules

Special modules

SIPLUS SM 1278 4xIO-Link Master

Technical specifications

Article number	6AG1278-4BD32-2XB0	6AG1278-4BD32-4XB0
Based on	6ES7278-4BD32-0XB0 SIPLUS S7-1200 SM 1278 IO-Link Master	6ES7278-4BD32-0XB0 SIPLUS S7-1200 SM 1278 IO-Link Master
Usage in industrial process technology		
- Against chemically active substances acc. to EN 60654-4	Yes; Class 3 (excluding trichlorethylene)	Yes; Class 3 (excluding trichlorethylene)
- Environmental conditions for process, measuring and control systems acc. to ANSI/ISA-71.04	Yes; Level GX group A/B (excluding trichlorethylene; harmful gas concentrations up to the limits of EN 60721-3-3 class 3C4 permissible); level LC3 (salt spray) and level LB3 (oil)	Yes; Level GX group A/B (excluding trichlorethylene; harmful gas concentrations up to the limits of EN 60721-3-3 class 3C4 permissible); level LC3 (salt spray) and level LB3 (oil)
Remark		
- Note regarding classification of environmental conditions acc. to EN 60721, EN 60654-4 and ANSI/ISA-71.04	* The supplied plug covers must remain in place over the unused interfaces during operation!	* The supplied plug covers must remain in place over the unused interfaces during operation!
Conformal coating		
• Coatings for printed circuit board assemblies acc. to EN 61086	Yes; Class 2 for high reliability	Yes; Class 2 for high reliability
• Protection against fouling acc. to EN 60664-3	Yes; Type 1 protection	Yes; Type 1 protection
• Military testing according to MIL-I-46058C, Amendment 7	Yes; Discoloration of coating possible during service life	Yes; Discoloration of coating possible during service life
• Qualification and Performance of Electrical Insulating Compound for Printed Board Assemblies according to IPC-CC-830A	Yes; Conformal coating, Class A	Yes; Conformal coating, Class A

Ordering data

Article No.

SIPLUS SM 1278

4xIO-Link Master signal module

(Extended temperature range and exposure to media)

- For areas with extreme exposure to media (conformal coating)
- -25 ... +70 °C, from +60 ... +70 °C number of simultaneously controllable inputs and outputs max. 50%

6AG1278-4BD32-4XB0

6AG1278-4BD32-2XB0

Overview



SIPLUS CMS1200 SM 1281 Condition Monitoring forms part of SIMATIC S7-1200 and is used for the:

- Monitoring of motors, generators, pumps, fans, or other mechanical components
- Recording and analysis of vibrations
- Expansion capability of up to 7 modules

3

Technical specifications

Article number	6AT8007-1AA10-0AA0 SM1281_Condition_Monitoring
General information	
Product type designation	SM1281
Product description	S7-1200 module for the monitoring of vibrations on mechanical components based on parameters and frequency-selective analysis functions
Installation type/mounting	
Mounting type	Rail or wall mounting
Mounting position	Horizontal, vertical
Recommended mounting position	Horizontal
Supply voltage	
Type of supply voltage	DC
Rated value (DC)	24 V
permissible range, lower limit (DC)	20.4 V
permissible range, upper limit (DC)	28.8 V
Input current	
Current consumption, typ.	200 mA
Current consumption, max.	250 mA
from backplane bus 5 V DC, typ.	80 mA
from backplane bus 5 V DC, max.	85 mA
Power loss	
Power loss, typ.	4.8 W
Memory	
Total memory capacity	1 Gbyte
Hardware configuration	
Design of hardware configuration	Modular, up to 7 modules per CPU
Speed input	
Number of speed inputs	1
Input voltage	
• 24 V DC digital	Yes
Sensor input	
Number of IEPE sensor inputs	4
Sampling frequency, max.	46 875 Hz

Article number	6AT8007-1AA10-0AA0 SM1281_Condition_Monitoring
Interfaces	
Type of data transmission	Export of raw data as WAV file for further analysis (e.g. using CMS X-Tools) can be downloaded via browser/FTP, online data transfer to CMS X-Tools
Ethernet interface	Yes
Protocols	
Bus communication	Yes
Web server	
• HTTP	Yes
Interrupts/diagnostics/status information	
Alarms	
• Diagnostic alarm	Yes
Diagnostics indication LED	
• for status of the inputs	Yes
• for maintenance	Yes
• Status indicator digital input (green)	No
Integrated Functions	
Monitoring functions	
• Monitoring of the sensor inputs	Yes; Cable break and short-circuit
• Vibration characteristic monitoring via RMS value of the vibration speed	Yes
• Vibration characteristic monitoring via RMS value of the vibration acceleration	Yes
• Vibration characteristic monitoring via diagnostic characteristic value	Yes
• Frequency-selective monitoring via vibration speed spectrum	Yes
• Frequency-selective monitoring via vibration acceleration spectrum	Yes
• Frequency-selective monitoring via envelope curve analysis	Yes

SIMATIC S7-1200 Basic Controllers

I/O modules

Special modules

SIPLUS CMS1200 SM 1281 Condition Monitoring

Technical specifications

Article number	6AT8007-1AA10-0AA0 SM1281_Condition_Monitoring
Measuring functions	
• Physical measuring principle	Vibration acceleration
Measuring range	
- Measurement range vibration frequency, min.	0.1 Hz
- Measurement range vibration frequency, max.	10 000 Hz
Standards, approvals, certificates	
Certificate of suitability	CE
Ambient conditions	
Free fall	
• Fall height, max.	0.3 m; five times, in product package
Relative humidity	
• Operation without condensation, min.	5 %
• Operation without condensation, max.	95 %
Software	
Browser software required	Web browser Mozilla Firefox (ESR31) or Microsoft Internet Explorer (10/11)
Connection method	
required front connector	Yes
Design of electrical connection	Screw connection
Mechanics/material	
Material of housing	Plastic: polycarbonate, abbreviation: PC- GF 10 FR
Dimensions	
Width	70 mm
Height	112 mm
Depth	75 mm
Weights	
Weight, approx.	260 g

Ordering data

Article No.

SIPLUS CMS1200 SM 1281 Condition Monitoring	6AT8007-1AA10-0AA0
Module for SIMATIC S7-1200 for monitoring vibrations in mechanical components based on characteristic values and frequency-selective analysis functions.	
Accessories	
SIPLUS CMS1200, SM 1281 shield clamp set	6AT8007-1AA20-0AA0
For EMC-compliant connection of signal and encoder cables to SIPLUS CMS1200 SM 1281 Condition Monitoring.	
VIB-SENSOR S01 vibration sensor	6AT8002-4AB00
Piezoelectric sensor for connection to SIPLUS CMS1200 SM 1281 Condition Monitoring.	
SIPLUS CABLE-MIL	
For connection of VIB-SENSOR S01 vibration sensor to SIPLUS CMS1200 SM 1281 Condition Monitoring.	
SIPLUS CABLE-MIL-300; length 3 m	6AT8002-4AC03
SIPLUS CABLE-MIL-1000; length 10 m	6AT8002-4AC10

Overview

The CP 1243-1 communications processor is used for connecting the SIMATIC S7-1200 to telecontrol centers via remote networks and telecontrol protocols (DNP3, IEC 60870-5-104, TeleControl Basic), and for safe communication via IP-based networks.

The CP has the following features:

- Ethernet-based connection to TeleControl Server Basic, e.g. via Internet
- Data transfer of measured values, control variables, or alarms optimized for telecontrol systems
- Automatic sending of alert emails
- Data buffering of up to 64,000 values ensures a secure database even with temporary connection failures
- Secure communication via VPN connections based on IPSec
- Access protection via Stateful Inspection Firewall
- Support of SINEMA Remote Connect with autoconfiguration
- Clearly laid out LED signaling for fast and easy diagnostics
- Compact industrial enclosure in S7-1200 design for mounting on a DIN rail
- Fast commissioning thanks to easy configuration using STEP 7

Note:

SIPLUS extreme products are based on SIMATIC standard products. The contents listed here were taken from the respective standard products. SIPLUS extreme-specific information was added.

Technical specifications

Article number	6AG1243-1BX30-2AX0
Based on	6GK7243-1BX30-0AX0
Product type designation	SIPLUS S7-1200 CP 1243-1
Ambient conditions	
Ambient temperature	
• for vertical installation during operation	-40 ... +60 °C
• for horizontally arranged busbars during operation	-40 ... +70 °C
• during storage	-40 ... +70 °C
• during transport	-40 ... +70 °C
Installation altitude at height above sea level maximum	5 000 m
Ambient condition relating to ambient temperature - air pressure - installation altitude	Tmin ... Tmax at 1 140 hPa ... 795 hPa (-1 000 m ... +2 000 m) // Tmin ... (Tmax - 10 K) at 795 hPa ... 658 hPa (+2 000 m ... +3 500 m) // Tmin ... (Tmax - 20 K) at 658 hPa ... 540 hPa (+3 500 m ... +5 000 m)
Relative humidity	
• with condensation acc. to IEC 60068-2-38 maximum	100 %; RH including condensation/frost (no commissioning when condensation is present), horizontal installation
Chemical resistance to commercially available cooling lubricants	Yes; incl. airborne diesel and oil droplets

Article number	6AG1243-1BX30-2AX0
Based on	6GK7243-1BX30-0AX0
Product type designation	SIPLUS S7-1200 CP 1243-1
Resistance to biologically active substances	
• conformity acc. to EN 60721-3-3	Yes; Class 3B2 mold and fungal spores (excluding fauna), Class 3B3 on request
• conformity acc. to EN 60721-3-6	Yes; Class 6B2 mold, fungal and dry rot spores (excluding fauna)
Resistance to chemically active substances	
• conformity acc. to EN 60721-3-3	Yes; Class 3C4 (RH < 75 %) incl. salt spray in accordance with EN 60068-2-52 (Severity 3). The supplied plug covers must remain in place on the unused interfaces during operation.
• conformity acc. to EN 60721-3-6	Yes
Resistance to mechanically active substances	
• conformity acc. to EN 60721-3-3	Yes; Class 3S4 incl. sand, dust. The supplied plug covers must remain in place over the unused interfaces during operation.
• conformity acc. to EN 60721-3-6	Yes; Class 6S3 incl. sand, dust. The supplied plug covers must remain in place over the unused interfaces during operation.

SIMATIC S7-1200 Basic Controllers

I/O modules

SIPLUS communication

SIPLUS CP 1243-1 communication modules**Technical specifications**

Article number	6AG1243-1BX30-2AX0
Based on	6GK7243-1BX30-0AX0
Product type designation	SIPLUS S7-1200 CP 1243-1
Coating for equipped printed circuit board acc. to EN 61086	Yes; Class 2 for high availability
Type of coating protection against pollution according to EN 60664-3	Yes; Protection of the type 1
Type of test of the coating acc. to MIL-I-46058C	Yes; Coating discoloration during service life possible
Product conformity of the coating Qualification and Performance of Electrical Insulating Compound for Printed Board Assemblies acc. to IPC-CC-830A	Yes; Conformal coating, class A
Protection class IP	IP20

Ordering data**SIPLUS CP 1243-1 communication processor**

(Extended temperature range and exposure to media)

Communications processor for connecting SIMATIC S7-1200 as an additional Ethernet interface and for connection to control centers via telecontrol protocols (DNP3, IEC 60870, TeleControl Basic), security (firewall, VPN)

*Accessories***Article No.****6AG1243-1BX30-2AX0**

See SIMATIC S7-1200 CP 1243-1 communications processor, catalog ST 70 · 2019, page 3/148

SIMATIC S7-1500 Advanced Controllers

**4/2 Central processing units**

4/2 [Standard CPUs](#)

4/2 CPU 1515-2 PN

4/6 CPU 1516-3 PN/DP

4/11 [SIPLUS standard CPUs](#)

4/11 SIPLUS CPU 1511-1 PN

4/14 SIPLUS CPU 1513-1 PN

4/17 [Fail-safe CPUs](#)

4/17 CPU 1515F-2 PN

4/22 CPU 1516F-3 PN/DP

4/27 I/O modules

4/27 [SIPLUS digital modules](#)

4/27 SIPLUS SM 521 digital input modules

4/30 SIPLUS SM 522 digital output modules

4/34 [SIPLUS analog modules](#)

4/34 SIPLUS SM 531 analog input modules

4/36 [Communication](#)

4/36 CM 8xIO-Link

4/38 CP 1545-1

4/41 [SIPLUS F-digital/analog modules](#)

4/41 SIPLUS digital F-input modules

4/43 SIPLUS digital F-output modules

SIMATIC S7-1500 Advanced Controllers

Central processing units
Standard CPUs

CPU 1515-2 PN

Overview



- The CPU for applications with medium to high requirements for program/data storage in the S7-1500 controller product range
- Medium to high processing speed for binary and floating-point arithmetic
- Used as central controller in production lines with central and distributed I/O
- PROFINET IO IRT interface with 2-port switch

- PROFINET IO controller for operating distributed I/O on PROFINET
- PROFINET I-Device for connecting the CPU as an intelligent PROFINET device under a SIMATIC or non-Siemens PROFINET IO controller
- Additional PROFINET interface with separate IP address for network separation, for connecting further PROFINET IO RT devices, or for high-speed communication as an I-Device
- OPC UA server and client as runtime option for the easy connection of SIMATIC S7-1500 to non-Siemens devices/systems with the functions:
 - OPC UA Data Access
 - OPC UA Security
 - OPC UA Methods Call
 - Support of OPC UA Companion specifications.
- Central and distributed isochronous mode
- Integrated Motion Control functionalities for controlling speed-controlled and positioning axes, precise position gearing between axes, support for external encoders, output cams/cam tracks and probes
- Integrated web server for diagnostics with the option of creating user-defined web pages

Note:

SIMATIC Memory Card required for operation of the CPU.

Technical specifications

Article number	6ES7515-2AM02-0AB0 CPU 1515-2 PN, 500KB Prog., 3MB Data
General information	
Product type designation	CPU 1515-2 PN
Engineering with	
• STEP 7 TIA Portal configurable/ integrated as of version	V16 (FW V2.8); with older TIA Portal versions configurable as 6ES7515-2AM01-0AB0
Display	
Screen diagonal [cm]	6.1 cm
Supply voltage	
Type of supply voltage	24 V DC
Memory	
Work memory	
• integrated (for program)	500 kbyte
• integrated (for data)	3 Mbyte
Load memory	
• Plug-in (SIMATIC Memory Card), max.	32 Gbyte
CPU processing times	
for bit operations, typ.	30 ns
for word operations, typ.	36 ns
for fixed point arithmetic, typ.	48 ns
for floating point arithmetic, typ.	192 ns
Counters, timers and their retentivity	
S7 counter	
• Number	2 048
IEC counter	
• Number	Any (only limited by the main memory)

Article number	6ES7515-2AM02-0AB0 CPU 1515-2 PN, 500KB Prog., 3MB Data
S7 times	
• Number	2 048
IEC timer	
• Number	Any (only limited by the main memory)
Data areas and their retentivity	
Flag	
• Number, max.	16 kbyte
Address area	
I/O address area	
• Inputs	32 kbyte; All inputs are in the process image
• Outputs	32 kbyte; All outputs are in the process image
Time of day	
Clock	
• Type	Hardware clock
1. Interface	
Interface types	
• Number of ports	2
• integrated switch	Yes
• RJ 45 (Ethernet)	Yes; X1
Protocols	
• IP protocol	Yes; IPv4
• PROFINET IO Controller	Yes
• PROFINET IO Device	Yes
• SIMATIC communication	Yes
• Open IE communication	Yes; Optionally also encrypted
• Web server	Yes
• Media redundancy	Yes

Technical specifications

Article number	6ES7515-2AM02-0AB0 CPU 1515-2 PN, 500KB Prog., 3MB Data
PROFINET IO Controller	
Services	
- PG/OP communication	Yes
- S7 routing	Yes
- Isochronous mode	Yes
- Direct data exchange	Yes; Requirement: IRT and isochronous mode (MRPD optional)
- IRT	Yes
- MRP	Yes; MRP Automanager acc. to IEC 62439-2 Edition 2.0; MRP Manager; MRP Client; max. number of devices in the ring: 50
- MRPD	Yes; Requirement: IRT
- PROFinenergy	Yes; per user program
- Prioritized startup	Yes; Max. 32 PROFINET devices
- Number of connectable I/O Devices, max.	256; In total, up to 1 000 distributed I/O devices can be connected via AS-i, PROFIBUS or PROFINET
- Of which IO devices with IRT, max.	64
- Number of connectable IO Devices for RT, max.	256
- of which in line, max.	256
- Number of IO Devices that can be simultaneously activated/deactivated, max.	8; in total across all interfaces
- Number of IO Devices per tool, max.	8
- Updating times	The minimum value of the update time also depends on communication share set for PROFINET IO, on the number of IO devices, and on the quantity of configured user data
Update time for IRT	
- for send cycle of 250 µs	250 µs to 4 ms; Note: In the case of IRT with isochronous mode, the minimum update time of 500 µs of the isochronous OB is decisive
- for send cycle of 500 µs	500 µs to 8 ms
- for send cycle of 1 ms	1 ms to 16 ms
- for send cycle of 2 ms	2 ms to 32 ms
- for send cycle of 4 ms	4 ms to 64 ms
- With IRT and parameterization of "odd" send cycles	Update time = set "odd" send clock (any multiple of 125 µs: 375 µs, 625 µs ... 3 875 µs)
Update time for RT	
- for send cycle of 250 µs	250 µs to 128 ms
- for send cycle of 500 µs	500 µs to 256 ms
- for send cycle of 1 ms	1 ms to 512 ms
- for send cycle of 2 ms	2 ms to 512 ms
- for send cycle of 4 ms	4 ms to 512 ms
PROFINET IO Device	
Services	
- PG/OP communication	Yes
- S7 routing	Yes
- Isochronous mode	No
- IRT	Yes
- MRP	Yes; MRP Automanager acc. to IEC 62439-2 Edition 2.0; MRP Manager; MRP Client; max. number of devices in the ring: 50
- MRPD	Yes; Requirement: IRT
- PROFinenergy	Yes; per user program

Article number	6ES7515-2AM02-0AB0 CPU 1515-2 PN, 500KB Prog., 3MB Data
Services (continued)	
- Shared device	Yes
- Number of IO Controllers with shared device, max.	4
- Asset management record	Yes; per user program
2. Interface	
Interface types	
• Number of ports	1
• integrated switch	No
• RJ 45 (Ethernet)	Yes; X2
Protocols	
• IP protocol	Yes; IPv4
• PROFINET IO Controller	Yes
• PROFINET IO Device	Yes
• SIMATIC communication	Yes
• Open IE communication	Yes; Optionally also encrypted
• Web server	Yes
• Media redundancy	No
PROFINET IO Controller	
Services	
- PG/OP communication	Yes
- S7 routing	Yes
- Isochronous mode	No
- Direct data exchange	No
- IRT	No
- MRP	No
- MRPD	No
- PROFinenergy	Yes; per user program
- Prioritized startup	No
- Number of connectable I/O Devices, max.	32; In total, up to 1 000 distributed I/O devices can be connected via AS-i, PROFIBUS or PROFINET
- Number of connectable IO Devices for RT, max.	32
- of which in line, max.	32
- Number of IO Devices that can be simultaneously activated/deactivated, max.	8; in total across all interfaces
- Number of IO Devices per tool, max.	8
- Updating times	The minimum value of the update time also depends on communication share set for PROFINET IO, on the number of IO devices, and on the quantity of configured user data
Update time for RT	
- for send cycle of 1 ms	1 ms to 512 ms
PROFINET IO Device	
Services	
- PG/OP communication	Yes
- S7 routing	Yes
- Isochronous mode	No
- IRT	No
- MRP	No
- MRPD	No
- PROFinenergy	Yes; per user program
- Prioritized startup	No
- Shared device	Yes
- Number of IO Controllers with shared device, max.	4

SIMATIC S7-1500 Advanced Controllers

Central processing units
Standard CPUs

CPU 1515-2 PN

Technical specifications

Article number	6ES7515-2AM02-0AB0 CPU 1515-2 PN, 500KB Prog., 3MB Data
Services (continued)	
- Asset management record	Yes; per user program
Protocols	
Number of connections	
• Number of connections, max.	192; via integrated interfaces of the CPU and connected CPs / CMs
OPC UA	
• OPC UA client	Yes
• OPC UA server	Yes; Data access (read, write, subscribe), method call, custom address space
Isochronous mode	
Isochronous operation (application synchronized up to terminal)	Yes; Distributed and central; with minimum OB 6x cycle of 500 µs (distributed) and 1 ms (central)
Supported technology objects	
Motion Control	Yes; Note: The number of axes affects the cycle time of the PLC program; selection guide via the TIA Selection Tool or SIZER
• Number of available Motion Control resources for technology objects	2 400
• Required Motion Control resources	
- per speed-controlled axis	40
- per positioning axis	80
- per synchronous axis	160
- per external encoder	80
- per output cam	20
- per cam track	160
- per probe	40
Controller	
• PID_Compact	Yes; Universal PID controller with integrated optimization
• PID_3Step	Yes; PID controller with integrated optimization for valves
• PID-Temp	Yes; PID controller with integrated optimization for temperature
Counting and measuring	
• High-speed counter	Yes

Article number	6ES7515-2AM02-0AB0 CPU 1515-2 PN, 500KB Prog., 3MB Data
Ambient conditions	
Ambient temperature during operation	
• horizontal installation, min.	-25 °C; No condensation
• horizontal installation, max.	60 °C; Display: 50 °C, at an operating temperature of typically 50 °C, the display is switched off
• vertical installation, min.	-25 °C; No condensation
• vertical installation, max.	40 °C; Display: 40 °C, at an operating temperature of typically 40 °C, the display is switched off
Altitude during operation relating to sea level	
• Installation altitude above sea level, max.	5 000 m; Restrictions for installation altitudes > 2 000 m, see manual
Configuration	
Programming	
Programming language	
- LAD	Yes
- FBD	Yes
- STL	Yes
- SCL	Yes
- GRAPH	Yes
Know-how protection	
• User program protection/password protection	Yes
• Copy protection	Yes
• Block protection	Yes
Access protection	
• Password for display	Yes
• Protection level: Write protection	Yes
• Protection level: Read/write protection	Yes
• Protection level: Complete protection	Yes
Dimensions	
Width	70 mm
Height	147 mm
Depth	129 mm
Weights	
Weight, approx.	830 g

Ordering data

Ordering data	Article No.
CPU 1515-2 PN	6ES7515-2AM02-0AB0
500 KB work memory for program, 3 MB for data, PROFINET IRT interface with 2-port switch, PROFINET RT interface; SIMATIC Memory Card required	
Accessories	
SIMATIC Memory Card	
4 MB	6ES7954-8LC03-0AA0
12 MB	6ES7954-8LE03-0AA0
24 MB	6ES7954-8LF03-0AA0
256 MB	6ES7954-8LL03-0AA0
2 GB	6ES7954-8LP02-0AA0
32 GB	6ES7954-8LT03-0AA0

Article No.

SIMATIC S7-1500 mounting rail

Fixed lengths, with grounding elements

- 160 mm
- 245 mm
- 482 mm
- 530 mm
- 830 mm

6ES7590-1AB60-0AA0
6ES7590-1AC40-0AA0
6ES7590-1AE80-0AA0
6ES7590-1AF30-0AA0
6ES7590-1AJ30-0AA0

For cutting to length by customer, without drill holes; grounding elements must be ordered separately

- 2 000 mm

6ES7590-1BC00-0AA0

PE connection element for mounting rail 2 000 mm

6ES7590-5AA00-0AA0

20 units

Ordering data	Article No.	Ordering data	Article No.
System power supply For supplying the backplane bus of the S7-1500 PLC 24 V DC input voltage, power 25 W 24/48/60 V DC input voltage, power 60 W 24/48/60 V DC input voltage, power 60 W, buffering functionality 120/230 V AC input voltage, power 60 W	6ES7505-0KA00-0AB0 6ES7505-0RA00-0AB0 6ES7505-0RB00-0AB0 6ES7507-0RA00-0AB0	IE FC stripping tool Pre-adjusted stripping tool for fast stripping of Industrial Ethernet FC cables	6GK1901-1GA00
Power plug With coding element for power supply module; spare part, 10 units	6ES7590-8AA00-0AA0	Display module 70 mm For CPU 1515-2 PN, CPU 1516-3 PN/DP, CPU 1515F-2 PN and CPU 1516F-3 PN/DP; spare part	6ES7591-1BB00-0AA0
Load power supply 24 V DC/3 A 24 V DC/8 A	6EP1332-4BA00 6EP1333-4BA00	Cover 70 mm For CPU 1515-2 PN, CPU 1516-3 PN/DP, CPU 1515F-2 PN and CPU 1516F-3 PN/DP; spare part	6ES7591-4BB00-0AA0
Power supply connector Spare part; for connecting the 24 V DC supply voltage • With push-in terminals	6ES7193-4JB00-0AA0	SIMATIC S7-1500 Starter Kit Comprising: CPU 1511C-1 PN, SIMATIC Memory Card 4 MB, 160 mm mounting rail, front connector, STEP 7 Professional 365-day license, SIMATIC ProDiag 1500, SIMATIC OPC UA S7-1500 Small, PM 1507 24 V/3 A power supply, Ethernet cable, documentation	6ES7511-1CK03-4YB5
IE FC RJ45 plugs RJ45 plug connector for Industrial Ethernet with a rugged metal enclosure and integrated insulation displacement contacts for connecting Industrial Ethernet FC installation cables		STEP 7 Professional V16 Target system: SIMATIC S7-1200, S7-1500, S7-300, S7-400, WinAC Requirement: Windows 7 Professional SP1 Windows 7 Enterprise SP1 Windows 7 Ultimate SP1 Windows 10 Professional Version 1809, 1903 Windows 10 Enterprise Version 1809, 1903 Windows 10 IoT Enterprise 2015 LTSC Windows 10 IoT Enterprise 2016 LTSC Windows 10 IoT Enterprise 2019 LTSC Windows Server 2012 R2 StdE (full installation) Windows Server 2016 Standard (full installation) Windows Server 2019 Standard (full installation) Type of delivery: German, English, Chinese, Italian, French, Spanish	
IE FC RJ45 plug 180 180° cable outlet 1 unit 10 units 50 units	6GK1901-1BB10-2AA0 6GK1901-1BB10-2AB0 6GK1901-1BB10-2AE0	STEP 7 Professional V16, floating license STEP 7 Professional V16, floating license, software download including license key ¹⁾ E-mail address required for delivery	6ES7822-1AA06-0YA5 6ES7822-1AE06-0YA5
IE FC TP standard cable GP 2x2 4-wire, shielded TP installation cable for connection to IE FC RJ45 outlet/IE FC RJ45 plug; PROFINET-compatible; with UL approval; sold by the meter; max. delivery unit 1 000 m, minimum order quantity 20 m	6XV1840-2AH10	SIMATIC Manual Collection Electronic manuals on DVD, multilingual: LOGO!, SIMADYN, SIMATIC bus components, SIMATIC C7, SIMATIC distributed I/O, SIMATIC HMI, SIMATIC sensors, SIMATIC NET, SIMATIC PC-based automation, SIMATIC PCS 7, SIMATIC PG/PC, SIMATIC S7, SIMATIC software, SIMATIC TDC	6ES7998-8XC01-8YE0
IE FC TP trailing cable 2 x 2 (Type C) 4-wire, shielded TP installation cable for connection to IE FC RJ45 outlet/IE FC RJ45 plug 180/90 for use in cable carrier; PROFINET-compatible; with UL approval; sold by the meter; max. delivery unit 1 000 m, minimum order quantity 20 m	6XV1840-3AH10	SIMATIC Manual Collection update service for 1 year Current Manual Collection DVD and the three subsequent updates	6ES7998-8XC01-8YE2
IE FC TP marine cable 2 x 2 (Type B) 4-wire, shielded TP installation cable for connection to IE FC RJ45 outlet/IE FC RJ45 plug 180/90 with marine approval; sold by the meter; max. delivery unit 1 000 m, minimum order quantity 20 m	6XV1840-4AH10		

¹⁾ For up-to-date information and download availability, see: <http://www.siemens.com/tia-online-software-delivery>

SIMATIC S7-1500 Advanced Controllers

Central processing units
Standard CPUs

CPU 1516-3 PN/DP

Overview



- The CPU with a large program and data memory in the S7-1500 controller product range for applications with high requirements regarding program scope and networking.
- High processing speed for binary and floating-point arithmetic
- Used as central controller in production lines with central and distributed I/O
- PROFINET IO IRT interface with 2-port switch

- PROFINET IO controller for operating distributed I/O on PROFINET.
- PROFINET I-Device for connecting the CPU as an intelligent PROFINET device under a SIMATIC or non-Siemens PROFINET IO controller.
- Additional PROFINET interface with separate IP address for network separation, for connecting further PROFINET IO RT devices, or for high-speed communication as an I-Device
- PROFIBUS DP master interface
- UA server and client as runtime option for easy connection of the SIMATIC S7-1500 to non-Siemens devices/systems with the functions:
 - OPC UA Data Access
 - OPC UA Security
 - OPC UA Methods Call
 - Support of OPC UA Companion specifications.
- Central and distributed isochronous mode on PROFIBUS and PROFINET
- Integrated Motion Control functionalities for controlling speed-controlled and positioning axes, support for external encoders, output cams/cam tracks and probes
- Integrated web server for diagnostics with the option of creating user-defined web pages

Note:

SIMATIC Memory Card required for operation of the CPU.

Technical specifications

Article number	6ES7516-3AN02-0AB0 CPU 1516-3 PN/DP, 1MB Prog., 5MB Data
General information	
Product type designation	CPU 1516-3 PN/DP
Engineering with	
• STEP 7 TIA Portal configurable/ integrated as of version	V16 (FW V2.8); with older TIA Portal versions configurable as 6ES7516-3AN01-0AB0
Display	
Screen diagonal [cm]	6.1 cm
Supply voltage	
Type of supply voltage	24 V DC
Memory	
Work memory	
• integrated (for program)	1 Mbyte
• integrated (for data)	5 Mbyte
Load memory	
• Plug-in (SIMATIC Memory Card), max.	32 Gbyte
CPU processing times	
for bit operations, typ.	10 ns
for word operations, typ.	12 ns
for fixed point arithmetic, typ.	16 ns
for floating point arithmetic, typ.	64 ns
Counters, timers and their retentivity	
S7 counter	
• Number	2 048
IEC counter	
• Number	Any (only limited by the main memory)
S7 times	
• Number	2 048

Article number	6ES7516-3AN02-0AB0 CPU 1516-3 PN/DP, 1MB Prog., 5MB Data
IEC timer	
• Number	Any (only limited by the main memory)
Data areas and their retentivity	
Flag	
• Number, max.	16 kbyte
Address area	
I/O address area	
• Inputs	32 kbyte; All inputs are in the process image
• Outputs	32 kbyte; All outputs are in the process image
Time of day	
Clock	
• Type	Hardware clock
1. Interface	
Interface types	
• Number of ports	2
• integrated switch	Yes
• RJ 45 (Ethernet)	Yes; X1
Protocols	
• IP protocol	Yes; IPv4
• PROFINET IO Controller	Yes
• PROFINET IO Device	Yes
• SIMATIC communication	Yes
• Open IE communication	Yes; Optionally also encrypted
• Web server	Yes
• Media redundancy	Yes

Technical specifications

Article number	6ES7516-3AN02-0AB0 CPU 1516-3 PN/DP, 1MB Prog., 5MB Data
PROFINET IO Controller	
Services	
- PG/OP communication	Yes
- S7 routing	Yes
- Isochronous mode	Yes
- Direct data exchange	Yes; Requirement: IRT and isochronous mode (MRPD optional)
- IRT	Yes
- MRP	Yes; MRP Automanager acc. to IEC 62439-2 Edition 2.0; MRP Manager; MRP Client; max. number of devices in the ring: 50
- MRPD	Yes; Requirement: IRT
- PROFINergy	Yes; per user program
- Prioritized startup	Yes; Max. 32 PROFINET devices
- Number of connectable I/O Devices, max.	256; In total, up to 1 000 distributed I/O devices can be connected via AS-i, PROFIBUS or PROFINET
- Of which IO devices with IRT, max.	64
- Number of connectable IO Devices for RT, max.	256
- of which in line, max.	256
- Number of IO Devices that can be simultaneously activated/deactivated, max.	8; in total across all interfaces
- Number of IO Devices per tool, max.	8
- Updating times	The minimum value of the update time also depends on communication share set for PROFINET IO, on the number of IO devices, and on the quantity of configured user data
Update time for IRT	
- for send cycle of 250 µs	250 µs to 4 ms; Note: In the case of IRT with isochronous mode, the minimum update time of 375 µs of the isochronous OB is decisive
- for send cycle of 500 µs	500 µs to 8 ms
- for send cycle of 1 ms	1 ms to 16 ms
- for send cycle of 2 ms	2 ms to 32 ms
- for send cycle of 4 ms	4 ms to 64 ms
- With IRT and parameterization of "odd" send cycles	Update time = set "odd" send clock (any multiple of 125 µs: 375 µs, 625 µs ... 3 875 µs)
Update time for RT	
- for send cycle of 250 µs	250 µs to 128 ms
- for send cycle of 500 µs	500 µs to 256 ms
- for send cycle of 1 ms	1 ms to 512 ms
- for send cycle of 2 ms	2 ms to 512 ms
- for send cycle of 4 ms	4 ms to 512 ms
PROFINET IO Device	
Services	
- PG/OP communication	Yes
- S7 routing	Yes
- Isochronous mode	No
- IRT	Yes
- MRP	Yes; MRP Automanager acc. to IEC 62439-2 Edition 2.0; MRP Manager; MRP Client; max. number of devices in the ring: 50

Article number	6ES7516-3AN02-0AB0 CPU 1516-3 PN/DP, 1MB Prog., 5MB Data
Services (continued)	
- MRPD	Yes; Requirement: IRT
- PROFINergy	Yes; per user program
- Shared device	Yes
- Number of IO Controllers with shared device, max.	4
- Asset management record	Yes; per user program
2. Interface	
Interface types	
• Number of ports	1
• integrated switch	No
• RJ 45 (Ethernet)	Yes; X2
Protocols	
• IP protocol	Yes; IPv4
• PROFINET IO Controller	Yes
• PROFINET IO Device	Yes
• SIMATIC communication	Yes
• Open IE communication	Yes; Optionally also encrypted
• Web server	Yes
• Media redundancy	No
PROFINET IO Controller	
Services	
- PG/OP communication	Yes
- S7 routing	Yes
- Isochronous mode	No
- Direct data exchange	No
- IRT	No
- MRP	No
- MRPD	No
- PROFINergy	Yes; per user program
- Prioritized startup	No
- Number of connectable I/O Devices, max.	32; In total, up to 1 000 distributed I/O devices can be connected via AS-i, PROFIBUS or PROFINET
- Number of connectable IO Devices for RT, max.	32
- of which in line, max.	32
- Number of IO Devices that can be simultaneously activated/deactivated, max.	8; in total across all interfaces
- Number of IO Devices per tool, max.	8
- Updating times	The minimum value of the update time also depends on communication share set for PROFINET IO, on the number of IO devices, and on the quantity of configured user data
Update time for RT	
- for send cycle of 1 ms	1 ms to 512 ms
PROFINET IO Device	
Services	
- PG/OP communication	Yes
- S7 routing	Yes
- Isochronous mode	No
- IRT	No
- MRP	No
- MRPD	No
- PROFINergy	Yes; per user program

SIMATIC S7-1500 Advanced Controllers

Central processing units
Standard CPUs

CPU 1516-3 PN/DP

Technical specifications

Article number	6ES7516-3AN02-0AB0 CPU 1516-3 PN/DP, 1MB Prog., 5MB Data
Services (continued)	
- Prioritized startup	No
- Shared device	Yes
- Number of IO Controllers with shared device, max.	4
- Asset management record	Yes; per user program
3. Interface	
Interface types	
• Number of ports	1
• RS 485	Yes; X3
Protocols	
• PROFIBUS DP master	Yes
• PROFIBUS DP slave	No
• SIMATIC communication	Yes
Protocols	
Number of connections	
• Number of connections, max.	256; via integrated interfaces of the CPU and connected CPs / CMs
PROFIBUS DP master	
Services	
- Number of DP slaves	125; In total, up to 1 000 distributed I/O devices can be connected via AS-i, PROFIBUS or PROFINET
OPC UA	
• OPC UA client	Yes
• OPC UA server	Yes; Data access (read, write, subscribe), method call, custom address space
Isochronous mode	
Isochronous operation (application synchronized up to terminal)	Yes; Distributed and central; with minimum OB 6x cycle of 375 µs (distributed) and 1 ms (central)
Supported technology objects	
Motion Control	Yes; Note: The number of axes affects the cycle time of the PLC program; selection guide via the TIA Selection Tool or SIZER
• Number of available Motion Control resources for technology objects	2 400
• Required Motion Control resources	
- per speed-controlled axis	40
- per positioning axis	80
- per synchronous axis	160
- per external encoder	80
- per output cam	20
- per cam track	160
- per probe	40

Article number	6ES7516-3AN02-0AB0 CPU 1516-3 PN/DP, 1MB Prog., 5MB Data
Controller	
• PID_Compact	Yes; Universal PID controller with integrated optimization
• PID_3Step	Yes; PID controller with integrated optimization for valves
• PID-Temp	Yes; PID controller with integrated optimization for temperature
Counting and measuring	
• High-speed counter	Yes
Ambient conditions	
Ambient temperature during operation	
• horizontal installation, min.	-25 °C; No condensation
• horizontal installation, max.	60 °C; Display: 50 °C, at an operating temperature of typically 50 °C, the display is switched off
• vertical installation, min.	-25 °C; No condensation
• vertical installation, max.	40 °C; Display: 40 °C, at an operating temperature of typically 40 °C, the display is switched off
Altitude during operation relating to sea level	
• Installation altitude above sea level, max.	5 000 m; Restrictions for installation altitudes > 2 000 m, see manual
Configuration	
Programming	
Programming language	
- LAD	Yes
- FBD	Yes
- STL	Yes
- SCL	Yes
- GRAPH	Yes
Know-how protection	
• User program protection/password protection	Yes
• Copy protection	Yes
• Block protection	Yes
Access protection	
• Password for display	Yes
• Protection level: Write protection	Yes
• Protection level: Read/write protection	Yes
• Protection level: Complete protection	Yes
Dimensions	
Width	70 mm
Height	147 mm
Depth	129 mm
Weights	
Weight, approx.	845 g

Ordering data	Article No.	Ordering data	Article No.
CPU 1516-3 PN/DP 1 MB work memory for program, 5 MB for data, PROFINET IRT interface with 2-port switch, PROFINET RT interface, PROFIBUS interface; SIMATIC Memory Card required	6ES7516-3AN02-0AB0	PROFIBUS FC standard cable GP Standard type with special design for quick mounting, 2-wire, shielded; sold by the meter; max. delivery unit 1 000 m, minimum order quantity 20 m	6XV1830-0EH10
Accessories		PROFIBUS FC robust cable 2-wire, shielded; sold by the meter; max. delivery unit 1 000 m, minimum order quantity 20 m	6XV1830-0JH10
SIMATIC Memory Card		PROFIBUS FC flexible cable 2-wire, shielded; sold by the meter; max. delivery unit 1 000 m, minimum order quantity 20 m	6XV1831-2K
4 MB	6ES7954-8LC03-0AA0	PROFIBUS FC trailing cable 2-wire, shielded; sold by the meter; max. delivery unit 1 000 m, minimum order quantity 20 m	
12 MB	6ES7954-8LE03-0AA0	Sheath color: Petrol	6XV1830-3EH10
24 MB	6ES7954-8LF03-0AA0	Sheath color: Violet	6XV1831-2L
256 MB	6ES7954-8LL03-0AA0	PROFIBUS FC food cable 2-wire, shielded; sold by the meter; max. delivery unit 1 000 m, minimum order quantity 20 m	6XV1830-0GH10
2 GB	6ES7954-8LP02-0AA0	PROFIBUS FC ground cable 2-wire, shielded; sold by the meter; max. delivery unit 1 000 m, minimum order quantity 20 m	6XV1830-3FH10
32 GB	6ES7954-8LT03-0AA0	PROFIBUS FC FRNC cable GP 2-wire, shielded, flame-retardant, with copolymer protective jacket FRNC; sold by the meter; max. delivery unit 1 000 m, minimum order quantity 20 m	6XV1830-0LH10
SIMATIC S7-1500 mounting rail		PROFIBUS FastConnect stripping tool Pre-adjusted stripping tool for fast stripping of PROFIBUS FastConnect bus cables	6GK1905-6AA00
Fixed lengths, with grounding elements		IE FC RJ45 plugs RJ45 plug connector for Industrial Ethernet with a rugged metal enclosure and integrated insulation displacement contacts for connecting Industrial Ethernet FC installation cables	
• 160 mm	6ES7590-1AB60-0AA0	IE FC RJ45 plug 180 180° cable outlet	
• 245 mm	6ES7590-1AC40-0AA0	1 unit	6GK1901-1BB10-2AA0
• 482 mm	6ES7590-1AE80-0AA0	10 units	6GK1901-1BB10-2AB0
• 530 mm	6ES7590-1AF30-0AA0	50 units	6GK1901-1BB10-2AE0
• 830 mm	6ES7590-1AJ30-0AA0	IE FC TP standard cable GP 2x2 4-wire, shielded TP installation cable for connection to IE FC RJ45 outlet/IE FC RJ45 plug; PROFINET-compatible; with UL approval; sold by the meter; max. delivery unit 1 000 m, minimum order quantity 20 m	6XV1840-2AH10
For cutting to length by customer, without drill holes; grounding elements must be ordered separately			
• 2 000 mm	6ES7590-1BC00-0AA0		
PE connection element for mounting rail 2 000 mm	6ES7590-5AA00-0AA0		
20 units			
System power supply			
For supplying the backplane bus of the S7-1500 PLC			
24 V DC input voltage, power 25 W	6ES7505-0KA00-0AB0		
24/48/60 V DC input voltage, power 60 W	6ES7505-0RA00-0AB0		
24/48/60 V DC input voltage, power 60 W, buffering functionality	6ES7505-0RB00-0AB0		
120/230 V AC input voltage, power 60 W	6ES7507-0RA00-0AB0		
Power plug	6ES7590-8AA00-0AA0		
With coding element for power supply module; spare part, 10 units			
Load power supply			
24 V DC/3 A	6EP1332-4BA00		
24 V DC/8 A	6EP1333-4BA00		
Power supply connector			
Spare part; for connecting the 24 V DC supply voltage			
• With push-in terminals	6ES7193-4JB00-0AA0		
PROFIBUS FastConnect bus connector RS485 with 90° cable outlet			
With insulation displacement, max. transmission rate 12 Mbps			
Without PG interface, grounding via control cabinet contact surface; 1 unit	6ES7972-0BA70-0XA0		
With PG interface, grounding via control cabinet contact surface; 1 unit	6ES7972-0BB70-0XA0		

SIMATIC S7-1500 Advanced Controllers

Central processing units
Standard CPUs

CPU 1516-3 PN/DP

4

Ordering data	Article No.	Article No.
IE FC TP trailing cable 2 x 2 (Type C) 4-wire, shielded TP installation cable for connection to IE FC RJ45 outlet/IE FC RJ45 plug 180/90 for use in cable carrier; PROFINET-compatible; with UL approval; sold by the meter; max. delivery unit 1 000 m, minimum order quantity 20 m	6XV1840-3AH10	STEP 7 Professional V16 Target system: SIMATIC S7-1200, S7-1500, S7-300, S7-400, WinAC Requirement: Windows 7 Professional SP1 Windows 7 Enterprise SP1 Windows 7 Ultimate SP1 Windows 10 Professional Version 1809, 1903 Windows 10 Enterprise Version 1809, 1903 Windows 10 IoT Enterprise 2015 LTSB Windows 10 IoT Enterprise 2016 LTSB Windows 10 IoT Enterprise 2019 LTSC Windows Server 2012 R2 StdE (full installation) Windows Server 2016 Standard (full installation) Windows Server 2019 Standard (full installation) Type of delivery: German, English, Chinese, Italian, French, Spanish STEP 7 Professional V16, floating license STEP 7 Professional V16, floating license, software download including license key ¹⁾ E-mail address required for delivery SIMATIC Manual Collection Electronic manuals on DVD, multilingual: LOGO!, SIMADYN, SIMATIC bus components, SIMATIC C7, SIMATIC distributed I/O, SIMATIC HMI, SIMATIC sensors, SIMATIC NET, SIMATIC PC-based automation, SIMATIC PCS 7, SIMATIC PG/PC, SIMATIC S7, SIMATIC software, SIMATIC TDC SIMATIC Manual Collection update service for 1 year Current Manual Collection DVD and the three subsequent updates
IE FC TP marine cable 2 x 2 (Type B) 4-wire, shielded TP installation cable for connection to IE FC RJ45 outlet/IE FC RJ45 plug 180/90 with marine approval; sold by the meter; max. delivery unit 1 000 m, minimum order quantity 20 m	6XV1840-4AH10	
IE FC stripping tool Pre-adjusted stripping tool for fast stripping of Industrial Ethernet FC cables	6GK1901-1GA00	
Display module 70 mm For CPU 1515-2 PN, CPU 1516-3 PN/DP, CPU 1515F-2 PN and CPU 1516F-3 PN/DP; spare part	6ES7591-1BB00-0AA0	
Cover 70 mm For CPU 1515-2 PN, CPU 1516-3 PN/DP, CPU 1515F-2 PN and CPU 1516F-3 PN/DP; spare part	6ES7591-4BB00-0AA0	
SIMATIC S7-1500 Starter Kit Comprising: CPU 1511C-1 PN, SIMATIC Memory Card 4 MB, 160 mm mounting rail, front connector, STEP 7 Professional 365-day license, SIMATIC ProDiag 1500, SIMATIC OPC UA S7-1500 Small, PM 1507 24 V/3 A power supply, Ethernet cable, documentation	6ES7511-1CK03-4YB5	

¹⁾ For up-to-date information and download availability, see: <http://www.siemens.com/tia-online-software-delivery>

Overview



- Entry-level CPU in the S7-1500 controller product range
- Suitable for applications with medium requirements for program scope and processing speed
- Used as central controller in production lines with central and distributed I/O
- PROFINET IO IRT interface with 2-port switch

- PROFINET IO controller for operating distributed I/O on PROFINET
- PROFINET I-Device for connecting the CPU as an intelligent PROFINET device under a SIMATIC or non-Siemens PROFINET I/O controller
- OPC UA server and client as runtime option for the easy connection of SIMATIC S7-1500 to non-Siemens devices/systems with the functions:
 - OPC UA Data Access
 - OPC UA Security
 - OPC UA Methods Call, Support
 - OPC UA Companion Specifications
- Central and distributed isochronous mode
- Integrated Motion Control functionalities for controlling speed-controlled and positioning axes, support for external encoders, output cams/cam tracks and probes
- Integrated web server for diagnostics with the option of creating user-defined web pages
- SIMATIC Memory Card required for operation of the CPU

Note:

SIPLUS extreme products are based on SIMATIC standard products. The contents listed here were adopted from the respective standard products. SIPLUS extreme-specific information was added.

Technical specifications

Article number	6AG1511-1AK02-2AB0	6AG1511-1AK02-7AB0
Based on	6ES7511-1AK02-0AB0 SIPLUS S7-1500 CPU 1511-1 PN	6ES7511-1AK02-0AB0 SIPLUS S7-1500 CPU 1511-1 PN
Ambient conditions		
Ambient temperature during operation		
• horizontal installation, min.	-40 °C; = Tmin (incl. condensation/frost)	-40 °C; = Tmin (incl. condensation/frost)
• horizontal installation, max.	60 °C; Display: 50 °C, at an operating temperature of typically 50 °C, the display is switched off	70 °C; Display: 50 °C, at an operating temperature of typically 50 °C, the display is switched off
• vertical installation, min.	-40 °C; = Tmin	-40 °C; = Tmin (incl. condensation/frost)
• vertical installation, max.	40 °C; Display: 40 °C, at an operating temperature of typically 40 °C, the display is switched off	40 °C; Display: 40 °C, at an operating temperature of typically 40 °C, the display is switched off
Altitude during operation relating to sea level		
• Installation altitude above sea level, max.	5 000 m	5 000 m
• Ambient air temperature-barometric pressure-altitude	Tmin ... Tmax at 1 080 hPa ... 795 hPa (-1 000 m ... +2 000 m) // Tmin ... (Tmax - 10 K) at 795 hPa ... 658 hPa (+2 000 m ... +3 500 m) // Tmin ... (Tmax - 20 K) at 658 hPa ... 540 hPa (+3 500 m ... +5 000 m)	Tmin ... Tmax at 1 080 hPa ... 795 hPa (-1 000 m ... +2 000 m) // Tmin ... (Tmax - 10 K) at 795 hPa ... 658 hPa (+2 000 m ... +3 500 m) // Tmin ... (Tmax - 20 K) at 658 hPa ... 540 hPa (+3 500 m ... +5 000 m)
Relative humidity		
• With condensation, tested in accordance with IEC 60068-2-38, max.	100 %; RH incl. condensation / frost (no commissioning in bedewed state), horizontal installation	100 %; RH incl. condensation / frost (no commissioning in bedewed state), horizontal installation
Resistance		
Coolants and lubricants		
- Resistant to commercially available coolants and lubricants	Yes; Incl. diesel and oil droplets in the air	Yes; Incl. diesel and oil droplets in the air

SIMATIC S7-1500 Advanced Controllers

Central processing units
SIPLUS standard CPUs

SIPLUS CPU 1511-1 PN

Technical specifications

Article number	6AG1511-1AK02-2AB0	6AG1511-1AK02-7AB0
Based on	6ES7511-1AK02-0AB0 SIPLUS S7-1500 CPU 1511-1 PN	6ES7511-1AK02-0AB0 SIPLUS S7-1500 CPU 1511-1 PN
Use in stationary industrial systems		
- to biologically active substances according to EN 60721-3-3	Yes; Class 3B2 mold, fungus and dry rot spores (with the exception of fauna); Class 3B3 on request	Yes; Class 3B2 mold, fungus and dry rot spores (with the exception of fauna); Class 3B3 on request
- to chemically active substances according to EN 60721-3-3	Yes; Class 3C4 (RH < 75%) incl. salt spray according to EN 60068-2-52 (degree of severity 3). The supplied connector covers must remain on the unused interfaces during operation!	Yes; Class 3C4 (RH < 75%) incl. salt spray according to EN 60068-2-52 (degree of severity 3). The supplied connector covers must remain on the unused interfaces during operation!
- to mechanically active substances according to EN 60721-3-3	Yes; Class 3S4 incl. sand, dust. The supplied connector covers must remain on the unused interfaces during operation!	Yes; Class 3S4 incl. sand, dust. The supplied connector covers must remain on the unused interfaces during operation!
Use on land craft, rail vehicles and special-purpose vehicles		
- to biologically active substances according to EN 60721-3-5		Yes; Class 5B2 mold, fungus and dry rot spores (with the exception of fauna); Class 5B3 on request
- to chemically active substances according to EN 60721-3-5		Yes; Class 5C3 (RH < 75 %) incl. salt spray acc. to EN 50155 (ST2); *
- to mechanically active substances according to EN 60721-3-5		Yes; Class 5S3 incl. sand, dust; *
Use on ships/at sea		
- to biologically active substances according to EN 60721-3-6	Yes; Class 6B2 mold and fungal spores (excluding fauna); Class 6B3 on request	Yes; Class 6B2 mold, fungal and dry rot spores (excluding fauna)
- to chemically active substances according to EN 60721-3-6	Yes; Class 6C3 (RH < 75 %) incl. salt spray acc. to EN 60068-2-52 (severity degree 3); *	Yes; Class 6C3 (RH < 75 %) incl. salt spray acc. to EN 60068-2-52 (severity degree 3); *
- to mechanically active substances according to EN 60721-3-6	Yes; Class 6S3 incl. sand, dust; *	Yes; Class 6S3 incl. sand, dust; *
Usage in industrial process technology		
- Against chemically active substances acc. to EN 60654-4	Yes; Class 3 (excluding trichlorethylene)	Yes; Class 3 (excluding trichlorethylene)
- Environmental conditions for process, measuring and control systems acc. to ANSI/ISA-71.04	Yes; Level GX group A/B (excluding trichlorethylene; harmful gas concentrations up to the limits of EN 60721-3-3 class 3C4 permissible); level LC3 (salt spray) and level LB3 (oil)	Yes; Level GX group A/B (excluding trichlorethylene; harmful gas concentrations up to the limits of EN 60721-3-3 class 3C4 permissible); level LC3 (salt spray) and level LB3 (oil)
Remark		
- Note regarding classification of environmental conditions acc. to EN 60721, EN 60654-4 and ANSI/ISA-71.04	* The supplied plug covers must remain in place over the unused interfaces during operation!	* The supplied plug covers must remain in place over the unused interfaces during operation!
Conformal coating		
• Coatings for printed circuit board assemblies acc. to EN 61086	Yes; Class 2 for high availability	Yes; Class 2 for high availability
• Protection against fouling acc. to EN 60664-3	Yes; Type 1 protection	Yes; Type 1 protection
• Military testing according to MIL-I-46058C, Amendment 7	Yes; Discoloration of coating possible during service life	Yes; Discoloration of coating possible during service life
• Qualification and Performance of Electrical Insulating Compound for Printed Board Assemblies according to IPC-CC-830A	Yes; Conformal coating, Class A	Yes; Conformal coating, Class A

Ordering data	Article No.
SIPLUS CPU 1511-1 PN (Extended temperature range and exposure to media) Work memory 150 KB for program, 1 MB for data, PROFINET IRT interface with 2-port switch; SIMATIC Memory Card required Temperature range -40 ... +60 °C Temperature range -40 ... +70 °C	6AG1511-1AK02-2AB0 6AG1511-1AK02-7AB0
System power supply (Extended temperature range and exposure to media) 24 V DC input voltage, power 25 W 24/48/60 V DC input voltage, power 60 W 120/230 V AC input voltage, power 60 W	6AG1505-0KA00-7AB0 6AG1505-0RA00-7AB0 6AG1507-0RA00-7AB0
Load power supply (Extended temperature range and exposure to media) 24 V DC/3 A 24 V DC/8 A	6AG1332-4BA00-7AA0 6AG1333-4BA00-7AA0
Display (Extended temperature range and exposure to media) For SIPLUS CPU 1511-1 PN and CPU 1513-1 PN; spare part	6AG1591-1AA01-2AA0
Further accessories	See SIMATIC S7-1500, CPU 1511-1 PN, catalog ST 70 · 2019, page 4/22

SIMATIC S7-1500 Advanced Controllers

Central processing units
SIPLUS standard CPUs

SIPLUS CPU 1513-1 PN

Overview



- The CPU for applications with medium/high requirements for program/data storage in the S7-1500 controller product range
- High processing speed for binary and floating-point arithmetic
- Used as central controller in production lines with central and distributed I/O
- PROFINET IO IRT interface with 2-port switch

- PROFINET IO controller for operating distributed I/O on PROFINET
- PROFINET I-Device for connecting the CPU as an intelligent PROFINET device under a SIMATIC or non-Siemens PROFINET I/O controller
- OPC UA server and client as runtime option for the easy connection of SIPLUS S7-1500 to non-Siemens devices/systems with the functions:
 - OPC UA Data Access
 - OPC UA Security
 - OPC UA Methods Call, Support
 - OPC UA Companion Specifications
- Central and distributed isochronous mode
- Integrated Motion Control functionalities for controlling speed-controlled and positioning axes, support for external encoders, output cams/cam tracks and probes
- Integrated web server for diagnostics with the option of creating user-defined web pages
- SIMATIC Memory Card required for operation of the CPU

Note:

SIPLUS extreme products are based on SIMATIC standard products. The contents listed here were adopted from the respective standard products. SIPLUS extreme-specific information was added.

Technical specifications

Article number	6AG1513-1AL02-2AB0	6AG1513-1AL02-7AB0
Based on	6ES7513-1AL02-0AB0 SIPLUS S7-1500 CPU 1513-1 PN	6ES7513-1AL02-0AB0 SIPLUS S7-1500 CPU 1513-1 PN
Ambient conditions		
Ambient temperature during operation		
• horizontal installation, min.	-40 °C; = Tmin (incl. condensation/frost)	-40 °C; = Tmin (incl. condensation/frost)
• horizontal installation, max.	60 °C; Display: 50 °C, at an operating temperature of typically 50 °C, the display is switched off	70 °C; Display: 50 °C, at an operating temperature of typically 50 °C, the display is switched off
• vertical installation, min.	-40 °C; = Tmin	-40 °C; = Tmin (incl. condensation/frost)
• vertical installation, max.	40 °C; Display: 40 °C, at an operating temperature of typically 40 °C, the display is switched off	40 °C; Display: 40 °C, at an operating temperature of typically 40 °C, the display is switched off
Altitude during operation relating to sea level		
• Installation altitude above sea level, max.	5 000 m	5 000 m
• Ambient air temperature-barometric pressure-altitude	Tmin ... Tmax at 1 080 hPa ... 795 hPa (-1 000 m ... +2 000 m) // Tmin ... (Tmax - 10 K) at 795 hPa ... 658 hPa (+2 000 m ... +3 500 m) // Tmin ... (Tmax - 20 K) at 658 hPa ... 540 hPa (+3 500 m ... +5 000 m)	Tmin ... Tmax at 1 080 hPa ... 795 hPa (-1 000 m ... +2 000 m) // Tmin ... (Tmax - 10 K) at 795 hPa ... 658 hPa (+2 000 m ... +3 500 m) // Tmin ... (Tmax - 20 K) at 658 hPa ... 540 hPa (+3 500 m ... +5 000 m)
Relative humidity		
• With condensation, tested in accordance with IEC 60068-2-38, max.	100 %; RH incl. condensation / frost (no commissioning in bedewed state), horizontal installation	100 %; RH incl. condensation / frost (no commissioning in bedewed state), horizontal installation
Resistance		
Coolants and lubricants		
- Resistant to commercially available coolants and lubricants	Yes; Incl. diesel and oil droplets in the air	Yes; Incl. diesel and oil droplets in the air

Technical specifications

Article number	6AG1513-1AL02-2AB0	6AG1513-1AL02-7AB0
Based on	6ES7513-1AL02-0AB0 SIPLUS S7-1500 CPU 1513-1 PN	6ES7513-1AL020-AB0 SIPLUS S7-1500 CPU 1513-1 PN
Use in stationary industrial systems		
- to biologically active substances according to EN 60721-3-3	Yes; Class 3B2 mold, fungus and dry rot spores (with the exception of fauna); Class 3B3 on request	Yes; Class 3B2 mold, fungus and dry rot spores (with the exception of fauna); Class 3B3 on request
- to chemically active substances according to EN 60721-3-3	Yes; Class 3C4 (RH < 75%) incl. salt spray according to EN 60068-2-52 (degree of severity 3). The supplied connector covers must remain on the unused interfaces during operation!	Yes; Class 3C4 (RH < 75%) incl. salt spray according to EN 60068-2-52 (degree of severity 3). The supplied connector covers must remain on the unused interfaces during operation!
- to mechanically active substances according to EN 60721-3-3	Yes; Class 3S4 incl. sand, dust. The supplied connector covers must remain on the unused interfaces during operation!	Yes; Class 3S4 incl. sand, dust. The supplied connector covers must remain on the unused interfaces during operation!
Use on land craft, rail vehicles and special-purpose vehicles		
- to biologically active substances according to EN 60721-3-5		Yes; Class 5B2 mold, fungus and dry rot spores (with the exception of fauna); Class 5B3 on request
- to chemically active substances according to EN 60721-3-5		Yes; Class 5C3 (RH < 75 %) incl. salt spray acc. to EN 50155 (ST2); *
- to mechanically active substances according to EN 60721-3-5		Yes; Class 5S3 incl. sand, dust; *
Use on ships/at sea		
- to biologically active substances according to EN 60721-3-6	Yes; Class 6B2 mold and fungal spores (excluding fauna); Class 6B3 on request	Yes; Class 6B2 mold, fungal and dry rot spores (excluding fauna)
- to chemically active substances according to EN 60721-3-6	Yes; Class 6C3 (RH < 75 %) incl. salt spray acc. to EN 60068-2-52 (severity degree 3); *	Yes; Class 6C3 (RH < 75 %) incl. salt spray acc. to EN 60068-2-52 (severity degree 3); *
- to mechanically active substances according to EN 60721-3-6	Yes; Class 6S3 incl. sand, dust; *	Yes; Class 6S3 incl. sand, dust; *
Usage in industrial process technology		
- Against chemically active substances acc. to EN 60654-4	Yes; Class 3 (excluding trichlorethylene)	Yes; Class 3 (excluding trichlorethylene)
- Environmental conditions for process, measuring and control systems acc. to ANSI/ISA-71.04	Yes; Level GX group A/B (excluding trichlorethylene; harmful gas concentrations up to the limits of EN 60721-3-3 class 3C4 permissible); level LC3 (salt spray) and level LB3 (oil)	Yes; Level GX group A/B (excluding trichlorethylene; harmful gas concentrations up to the limits of EN 60721-3-3 class 3C4 permissible); level LC3 (salt spray) and level LB3 (oil)
Remark		
- Note regarding classification of environmental conditions acc. to EN 60721, EN 60654-4 and ANSI/ISA-71.04	* The supplied plug covers must remain in place over the unused interfaces during operation!	* The supplied plug covers must remain in place over the unused interfaces during operation!
Conformal coating		
• Coatings for printed circuit board assemblies acc. to EN 61086	Yes; Class 2 for high availability	Yes; Class 2 for high availability
• Protection against fouling acc. to EN 60664-3	Yes; Type 1 protection	Yes; Type 1 protection
• Military testing according to MIL-I-46058C, Amendment 7	Yes; Discoloration of coating possible during service life	Yes; Discoloration of coating possible during service life
• Qualification and Performance of Electrical Insulating Compound for Printed Board Assemblies according to IPC-CC-830A	Yes; Conformal coating, Class A	Yes; Conformal coating, Class A

SIMATIC S7-1500 Advanced Controllers

Central processing units
SIPLUS standard CPUs

SIPLUS CPU 1513-1 PN

Ordering data	Article No.
<p>SIPLUS CPU 1513-1 PN (Extended temperature range and exposure to media) 300 KB work memory for program, 1.5 MB for data, PROFINET IRT interface with 2-port switch; SIMATIC Memory Card required Temperature range -40 ... +60 °C Temperature range -40 ... +70 °C</p>	<p>6AG1513-1AL02-2AB0 6AG1513-1AL02-7AB0</p>
<p>Accessories Power supply (Extended temperature range and exposure to media) 24 V DC input voltage, power 25 W 24/48/60 V DC input voltage, power 60 W 120/230 V AC input voltage, power 60 W</p>	<p>6AG1505-0KA00-7AB0 6AG1505-0RA00-7AB0 6AG1507-0RA00-7AB0</p>
<p>Load power supply (Extended temperature range and exposure to media) 24 V DC/3 A 24 V DC/8 A</p>	<p>6AG1332-4BA00-7AA0 6AG1333-4BA00-7AA0</p>
<p>Display (Extended temperature range and exposure to media) For SIPLUS CPU 1511-1 PN and CPU 1513-1 PN; spare part</p>	<p>6AG1591-1AA01-2AA0</p>
<p>Further accessories</p>	<p>See SIMATIC S7-1500, CPU 1513-1 PN, catalog ST 70 · 2019, page 4/22</p>

Overview

- The CPU for applications with medium to high requirements for program/data storage in the S7-1500 controller product range
- Can be used for failsafe functions up to SIL 3 according to IEC 61508 and up to PLe according to ISO 13849.
- Medium to high processing speed for binary and floating-point arithmetic
- Used as central controller in production lines with central and distributed I/O
- Supports PROFIsafe in centralized and distributed configurations
- PROFINET IO IRT interface with 2-port switch
- Additional PROFINET interface with separate IP address
- PROFINET IO controller for operating distributed I/O on PROFINET
- PROFINET I-Device for connecting the CPU as an intelligent PROFINET device under a SIMATIC or non-Siemens PROFINET I/O controller
- Isochronous mode
- Integrated Motion Control functionalities for controlling speed-controlled and positioning axes, support for external encoders
- Integrated web server with the option of creating user-defined web pages

Note

SIMATIC Memory Card required for operation of the CPU

Technical specifications

Article number	6ES7515-2FM02-0AB0 CPU 1515F-2 PN, 750KB Prog., 3MB Data
General information	
Product type designation	CPU 1515F-2 PN
Engineering with	
• STEP 7 TIA Portal configurable/ integrated as of version	V16 (FW V2.8) / as of V13 SP1 (FW V1.8) configurable with 6ES7515-2FM01-0AB0
Display	
Screen diagonal [cm]	6.1 cm
Supply voltage	
Type of supply voltage	24 V DC
Memory	
Work memory	
• integrated (for program)	750 kbyte
• integrated (for data)	3 Mbyte
Load memory	
• Plug-in (SIMATIC Memory Card), max.	32 Gbyte
CPU processing times	
for bit operations, typ.	30 ns
for word operations, typ.	36 ns
for fixed point arithmetic, typ.	48 ns
for floating point arithmetic, typ.	192 ns
Counters, timers and their retentivity	
S7 counter	
• Number	2 048
IEC counter	
• Number	Any (only limited by the main memory)

Article number	6ES7515-2FM02-0AB0 CPU 1515F-2 PN, 750KB Prog., 3MB Data
S7 times	
• Number	2 048
IEC timer	
• Number	Any (only limited by the main memory)
Data areas and their retentivity	
Flag	
• Number, max.	16 kbyte
Address area	
I/O address area	
• Inputs	32 kbyte; All inputs are in the process image
• Outputs	32 kbyte; All outputs are in the process image
Time of day	
Clock	
• Type	Hardware clock
1. Interface	
Interface types	
• Number of ports	2
• integrated switch	Yes
• RJ 45 (Ethernet)	Yes; X1
Protocols	
• IP protocol	Yes; IPv4
• PROFINET IO Controller	Yes
• PROFINET IO Device	Yes
• SIMATIC communication	Yes
• Open IE communication	Yes; Optionally also encrypted

SIMATIC S7-1500 Advanced Controllers

Central processing units
Fail-safe CPUs

CPU 1515F-2 PN

Technical specifications

Article number	6ES7515-2FM02-0AB0 CPU 1515F-2 PN, 750KB Prog., 3MB Data
Protocols (continued)	
• Web server	Yes
• Media redundancy	Yes; MRP Automanager according to IEC 62439-2 Edition 2.0
PROFINET IO Controller	
Services	
- PG/OP communication	Yes
- S7 routing	Yes
- Isochronous mode	Yes
- Direct data exchange	Yes; Requirement: IRT and isochronous mode (MRPD optional)
- IRT	Yes
- MRP	Yes; MRP Automanager acc. to IEC 62439-2 Edition 2.0; MRP Manager; MRP Client; max. number of devices in the ring: 50
- MRPD	Yes; Requirement: IRT
- PROFINergy	Yes
- Prioritized startup	Yes; Max. 32 PROFINET devices
- Number of connectable IO Devices, max.	256; In total, up to 1 000 distributed I/O devices can be connected via AS-i, PROFIBUS or PROFINET
- Of which IO devices with IRT, max.	64
- Number of connectable IO Devices for RT, max.	256
- of which in line, max.	256
- Number of IO Devices that can be simultaneously activated/deactivated, max.	8; in total across all interfaces
- Number of IO Devices per tool, max.	8
- Updating times	The minimum value of the update time also depends on communication share set for PROFINET IO, on the number of IO devices, and on the quantity of configured user data
Update time for IRT	
- for send cycle of 250 µs	250 µs to 4 ms; Note: In the case of IRT with isochronous mode, the minimum update time of 500 µs of the isochronous OB is decisive
- for send cycle of 500 µs	500 µs to 8 ms
- for send cycle of 1 ms	1 ms to 16 ms
- for send cycle of 2 ms	2 ms to 32 ms
- for send cycle of 4 ms	4 ms to 64 ms
- With IRT and parameterization of "odd" send cycles	Update time = set "odd" send clock (any multiple of 125 µs: 375 µs, 625 µs ... 3 875 µs)
Update time for RT	
- for send cycle of 250 µs	250 µs to 128 ms
- for send cycle of 500 µs	500 µs to 256 ms
- for send cycle of 1 ms	1 ms to 512 ms
- for send cycle of 2 ms	2 ms to 512 ms
- for send cycle of 4 ms	4 ms to 512 ms

Article number	6ES7515-2FM02-0AB0 CPU 1515F-2 PN, 750KB Prog., 3MB Data
PROFINET IO Device	
Services	
- PG/OP communication	Yes
- S7 routing	Yes
- Isochronous mode	No
- IRT	Yes
- MRP	Yes; MRP Automanager acc. to IEC 62439-2 Edition 2.0; MRP Manager; MRP Client; max. number of devices in the ring: 50
- MRPD	Yes; Requirement: IRT
- PROFINergy	Yes; per user program
- Shared device	Yes
- Number of IO Controllers with shared device, max.	4
- Asset management record	Yes; per user program
2. Interface	
Interface types	
• Number of ports	1
• integrated switch	No
• RJ 45 (Ethernet)	Yes; X2
Protocols	
• IP protocol	Yes; IPv4
• PROFINET IO Controller	Yes
• PROFINET IO Device	Yes
• SIMATIC communication	Yes
• Open IE communication	Yes
• Web server	Yes
• Media redundancy	No
PROFINET IO Controller	
Services	
- PG/OP communication	Yes
- S7 routing	Yes
- Isochronous mode	No
- Direct data exchange	No
- IRT	No
- MRP	No
- MRPD	No
- PROFINergy	Yes
- Prioritized startup	No
- Number of connectable IO Devices, max.	32; In total, up to 1 000 distributed I/O devices can be connected via AS-i, PROFIBUS or PROFINET
- Number of connectable IO Devices for RT, max.	32
- of which in line, max.	32
- Number of IO Devices that can be simultaneously activated/deactivated, max.	8; in total across all interfaces
- Number of IO Devices per tool, max.	8
- Updating times	The minimum value of the update time also depends on communication share set for PROFINET IO, on the number of IO devices, and on the quantity of configured user data

Technical specifications

Article number	6ES7515-2FM02-0AB0 CPU 1515F-2 PN, 750KB Prog., 3MB Data
Update time for RT - for send cycle of 1 ms	1 ms to 512 ms
PROFINET IO Device	
Services	
- PG/OP communication	Yes
- S7 routing	Yes
- Isochronous mode	No
- Open IE communication	Yes
- IRT	No
- MRP	No
- MRPD	No
- PROFIenergy	Yes
- Prioritized startup	No
- Shared device	Yes
- Number of IO Controllers with shared device, max.	4
- Asset management record	Yes; per user program
Protocols	
Number of connections	
• Number of connections, max.	192; via integrated interfaces of the CPU and connected CPs / CMs
OPC UA	
• OPC UA client	Yes
• OPC UA server	Yes; Data access (read, write, subscribe), method call, custom address space
Isochronous mode	
Isochronous operation (application synchronized up to terminal)	Yes; Distributed and central; with minimum OB 6x cycle of 500 µs (distributed) and 1 ms (central)
Supported technology objects	
Motion Control	Yes; Note: The number of axes affects the cycle time of the PLC program; selection guide via the TIA Selection Tool or SIZER
• Number of available Motion Control resources for technology objects	2 400
• Required Motion Control resources	
- per speed-controlled axis	40
- per positioning axis	80
- per synchronous axis	160
- per external encoder	80
- per output cam	20
- per cam track	160
- per probe	40
Controller	
• PID_Compact	Yes; Universal PID controller with integrated optimization
• PID_3Step	Yes; PID controller with integrated optimization for valves
• PID-Temp	Yes; PID controller with integrated optimization for temperature
Counting and measuring	
• High-speed counter	Yes

Article number	6ES7515-2FM02-0AB0 CPU 1515F-2 PN, 750KB Prog., 3MB Data
Standards, approvals, certificates	
Highest safety class achievable in safety mode	
Probability of failure (for service life of 20 years and repair time of 100 hours)	
- Low demand mode: PFDavg in accordance with SIL3	< 2.00E-05
- High demand/continuous mode: PFH in accordance with SIL3	< 1.00E-09
Ambient conditions	
Ambient temperature during operation	
• horizontal installation, min.	-25 °C; No condensation
• horizontal installation, max.	60 °C; Display: 50 °C, at an operating temperature of typically 50 °C, the display is switched off
• vertical installation, min.	-25 °C; No condensation
• vertical installation, max.	40 °C; Display: 40 °C, at an operating temperature of typically 40 °C, the display is switched off
Altitude during operation relating to sea level	
• Installation altitude above sea level, max.	5 000 m; Restrictions for installation altitudes > 2 000 m, see manual
Configuration	
Programming	
Programming language	
- LAD	Yes; incl. failsafe
- FBD	Yes; incl. failsafe
- STL	Yes
- SCL	Yes
- GRAPH	Yes
Know-how protection	
• User program protection/password protection	Yes
• Copy protection	Yes
• Block protection	Yes
Access protection	
• Password for display	Yes
• Protection level: Write protection	Yes; Specific write protection both for Standard and for Failsafe
• Protection level: Read/write protection	Yes
• Protection level: Complete protection	Yes
Dimensions	
Width	70 mm
Height	147 mm
Depth	129 mm
Weights	
Weight, approx.	830 g

SIMATIC S7-1500 Advanced Controllers

Central processing units

Fail-safe CPUs

CPU 1515F-2 PN

Ordering data

CPU 1515F-2 PN

Fail-safe CPU, 750 KB work memory for program, 3 MB for data, PROFINET IRT interface with 2-port switch; PROFINET RT interface; SIMATIC Memory Card required

Accessories

SIMATIC Memory Card

4 MB	6ES7954-8LC03-0AA0
12 MB	6ES7954-8LE03-0AA0
24 MB	6ES7954-8LF03-0AA0
256 MB	6ES7954-8LL03-0AA0
2 GB	6ES7954-8LP02-0AA0
32 GB	6ES7954-8LT03-0AA0

SIMATIC S7-1500 mounting rail

Fixed lengths, with grounding elements

- 160 mm
- 245 mm
- 482 mm
- 530 mm
- 830 mm

For cutting to length by customer, without drill holes; grounding elements must be ordered separately

- 2 000 mm

PE connection element for mounting rail 2 000 mm

20 units

System power supply

For supplying the backplane bus of the S7-1500 PLC

24 V DC input voltage, power 25 W	6ES7505-0KA00-0AB0
24/48/60 V DC input voltage, power 60 W	6ES7505-0RA00-0AB0
24/48/60 V DC input voltage, power 60 W, buffering functionality	6ES7505-0RB00-0AB0
120/230 V AC input voltage, power 60 W	6ES7507-0RA00-0AB0

Power plug

With coding element for power supply module; spare part, 10 units

Load power supply

24 V DC/3 A	6EP1332-4BA00
24 V DC/8 A	6EP1333-4BA00

Power supply connector

Spare part; for connecting the 24 V DC supply voltage

- With push-in terminals

Article No.

6ES7515-2FM02-0AB0

6ES7954-8LC03-0AA0

6ES7954-8LE03-0AA0

6ES7954-8LF03-0AA0

6ES7954-8LL03-0AA0

6ES7954-8LP02-0AA0

6ES7954-8LT03-0AA0

6ES7590-1AB60-0AA0

6ES7590-1AC40-0AA0

6ES7590-1AE80-0AA0

6ES7590-1AF30-0AA0

6ES7590-1AJ30-0AA0

6ES7590-1BC00-0AA0

6ES7590-5AA00-0AA0

6ES7505-0KA00-0AB0

6ES7505-0RA00-0AB0

6ES7505-0RB00-0AB0

6ES7507-0RA00-0AB0

6ES7590-8AA00-0AA0

6EP1332-4BA00

6EP1333-4BA00

6ES7193-4JB00-0AA0

Article No.

IE FC RJ45 plugs

RJ45 plug connector for Industrial Ethernet with a rugged metal enclosure and integrated insulation displacement contacts for connecting Industrial Ethernet FC installation cables

IE FC RJ45 plug 180

180° cable outlet

1 unit

10 units

50 units

6GK1901-1BB10-2AA0

6GK1901-1BB10-2AB0

6GK1901-1BB10-2AE0

IE FC TP standard cable GP 2x2

4-wire, shielded TP installation cable for connection to IE FC RJ45 outlet/IE FC RJ45 plug; PROFINET-compatible; with UL approval; sold by the meter; max. delivery unit 1 000 m, minimum order quantity 20 m

6XV1840-2AH10

IE FC TP trailing cable 2 x 2 (Type C)

4-wire, shielded TP installation cable for connection to IE FC RJ45 outlet/IE FC RJ45 plug 180/90 for use in cable carrier; PROFINET-compatible; with UL approval; sold by the meter; max. delivery unit 1 000 m, minimum order quantity 20 m

6XV1840-3AH10

IE FC TP marine cable 2 x 2 (Type B)

4-wire, shielded TP installation cable for connection to IE FC RJ45 outlet/IE FC RJ45 plug 180/90 with marine approval; sold by the meter; max. delivery unit 1 000 m, minimum order quantity 20 m

6XV1840-4AH10

IE FC stripping tool

Pre-adjusted stripping tool for fast stripping of Industrial Ethernet FC cables

6GK1901-1GA00

Display module 70 mm

For CPU 1515-2 PN, CPU 1516-3 PN/DP, CPU 1515F-2 PN and CPU 1516F-3 PN/DP; spare part

6ES7591-1BB00-0AA0

Cover 70 mm

For CPU 1515-2 PN, CPU 1516-3 PN/DP, CPU 1515F-2 PN and CPU 1516F-3 PN/DP; spare part

6ES7591-4BB00-0AA0

Ordering data	Article No.	Article No.	
<p>STEP 7 Professional V16</p> <p>Target system: SIMATIC S7-1200, S7-1500, S7-300, S7-400, WinAC</p> <p>Requirement: Windows 7 Professional SP1 Windows 7 Enterprise SP1 Windows 7 Ultimate SP1 Windows 10 Professional Version 1809, 1903 Windows 10 Enterprise Version 1809, 1903 Windows 10 IoT Enterprise 2015 LTSB Windows 10 IoT Enterprise 2016 LTSB Windows 10 IoT Enterprise 2019 LTSC Windows Server 2012 R2 StdE (full installation) Windows Server 2016 Standard (full installation) Windows Server 2019 Standard (full installation)</p> <p>Type of delivery: en, de, fr, it, es, zh</p> <p>STEP 7 Professional V16, floating license</p> <p>STEP 7 Professional V16, floating license, software download including license key ¹⁾</p> <p>E-mail address required for delivery</p>	<p>6ES7822-1AA06-0YA5</p> <p>6ES7822-1AE06-0YA5</p>	<p>STEP 7 Safety Advanced V16</p> <p>Task: Engineering tool for configuring and programming fail-safe user programs for SIMATIC S7-1200 FC, S7-1500F, S7-1500F Software Controller, S7-300F, S7-400F, WinAC RTX F, ET 200SP F Controller and the fail-safe ET 200SP, ET 200MP, ET 200S, ET 200M, ET 200iSP, ET 200pro and ET 200eco I/O</p> <p>Requirement: STEP 7 Professional V16</p> <p>Note: As from TIA Portal V16, the SIMATIC STEP 7 Safety software is an integral part of the SIMATIC STEP 7 product setup. The functionality of SIMATIC STEP 7 Safety is activated by means of the license key supplied in each case.</p> <p>Floating license for 1 user; license key on USB flash drive</p> <p>Floating license for 1 user, license key for download¹⁾; e-mail address required for delivery</p> <p>SIMATIC Manual Collection</p> <p>Electronic manuals on DVD, multilingual: LOGO!, SIMADYN, SIMATIC bus components, SIMATIC C7, SIMATIC distributed I/O, SIMATIC HMI, SIMATIC sensors, SIMATIC NET, SIMATIC PC-based automation, SIMATIC PCS 7, SIMATIC PG/PC, SIMATIC S7, SIMATIC software, SIMATIC TDC</p> <p>SIMATIC Manual Collection update service for 1 year</p> <p>Current Manual Collection DVD and the three subsequent updates</p>	<p>6ES7833-1FA16-0YA5</p> <p>6ES7833-1FA16-0YH5</p> <p>6ES7998-8XC01-8YE0</p> <p>6ES7998-8XC01-8YE2</p>

¹⁾ For up-to-date information and download availability, see:
<http://www.siemens.com/tia-online-software-delivery>

SIMATIC S7-1500 Advanced Controllers

Central processing units
Fail-safe CPUs

CPU 1516F-3 PN/DP

Overview



- The CPU with a large program and data memory in the S7-1500 controller product range for failsafe applications with high requirements regarding program scope and networking.
- Can be used for failsafe functions up to SIL 3 according to IEC 61508 and up to PLe according to ISO 13849.

- High processing speed for binary and floating-point arithmetic
- Used as central controller in production lines with central and distributed I/O.
- Supports PROFIsafe in centralized and distributed configuration.
- PROFINET IO IRT interface with 2-port switch.
- Additional PROFINET interface with separate IP address.
- PROFINET IO controller for operating distributed I/O on PROFINET.
- PROFINET I-Device for connecting the CPU as an intelligent PROFINET device under a SIMATIC or non-Siemens PROFINET IO controller.
- PROFIBUS DP master interface.
- Isochronous mode on PROFIBUS and PROFINET.
- Integrated Motion Control functionalities for controlling speed-controlled and positioning axes, support for external encoders.
- Integrated web server with the option of creating user-defined web pages.

Note:

SIMATIC Memory Card required for operation of the CPU

Technical specifications

Article number	6ES7516-3FN02-0AB0 CPU 1516F-3 PN/DP, 1,5MB Prog, 5MB Data
General information	
Product type designation	CPU 1516F-3 PN/DP
Engineering with	
• STEP 7 TIA Portal configurable/ integrated as of version	V16 (FW V2.8); with older TIA Portal versions configurable as 6ES7516-3AN01-0AB0
Display	
Screen diagonal [cm]	6.1 cm
Supply voltage	
Type of supply voltage	24 V DC
Memory	
Work memory	
• integrated (for program)	1.5 Mbyte
• integrated (for data)	5 Mbyte
Load memory	
• Plug-in (SIMATIC Memory Card), max.	32 Gbyte
CPU processing times	
for bit operations, typ.	10 ns
for word operations, typ.	12 ns
for fixed point arithmetic, typ.	16 ns
for floating point arithmetic, typ.	64 ns
Counters, timers and their retentivity	
S7 counter	
• Number	2 048
IEC counter	
• Number	Any (only limited by the main memory)
S7 times	
• Number	2 048

Article number	6ES7516-3FN02-0AB0 CPU 1516F-3 PN/DP, 1,5MB Prog, 5MB Data
IEC timer	
• Number	Any (only limited by the main memory)
Data areas and their retentivity	
Flag	
• Number, max.	16 kbyte
Address area	
I/O address area	
• Inputs	32 kbyte; All inputs are in the process image
• Outputs	32 kbyte; All outputs are in the process image
Time of day	
Clock	
• Type	Hardware clock
1. Interface	
Interface types	
• Number of ports	2
• integrated switch	Yes
• RJ 45 (Ethernet)	Yes; X1
Protocols	
• IP protocol	Yes; IPv4
• PROFINET IO Controller	Yes
• PROFINET IO Device	Yes
• SIMATIC communication	Yes
• Open IE communication	Yes; Optionally also encrypted
• Web server	Yes
• Media redundancy	Yes; MRP Automanager according to IEC 62439-2 Edition 2.0

Technical specifications

Article number	6ES7516-3FN02-0AB0 CPU 1516F-3 PN/DP, 1,5MB Prog, 5MB Data
PROFINET IO Controller	
Services	
- PG/OP communication	Yes
- S7 routing	Yes
- Isochronous mode	Yes
- Direct data exchange	Yes; Requirement: IRT and isochronous mode (MRPD optional)
- Open IE communication	Yes
- IRT	Yes
- MRP	Yes; MRP Automanager acc. to IEC 62439-2 Edition 2.0; MRP Manager; MRP Client; max. number of devices in the ring: 50
- MRPD	Yes; Requirement: IRT
- PROFINergy	Yes
- Prioritized startup	Yes; Max. 32 PROFINET devices
- Number of connectable IO Devices, max.	256; In total, up to 1 000 distributed I/O devices can be connected via AS-i, PROFIBUS or PROFINET
- Of which IO devices with IRT, max.	64
- Number of connectable IO Devices for RT, max.	256
- of which in line, max.	256
- Number of IO Devices that can be simultaneously activated/deactivated, max.	8; in total across all interfaces
- Number of IO Devices per tool, max.	8
- Updating times	The minimum value of the update time also depends on communication share set for PROFINET IO, on the number of IO devices, and on the quantity of configured user data
Update time for IRT	
- for send cycle of 250 µs	250 µs to 4 ms; Note: In the case of IRT with isochronous mode, the minimum update time of 375 µs of the isochronous OB is decisive
- for send cycle of 500 µs	500 µs to 8 ms
- for send cycle of 1 ms	1 ms to 16 ms
- for send cycle of 2 ms	2 ms to 32 ms
- for send cycle of 4 ms	4 ms to 64 ms
- With IRT and parameterization of "odd" send cycles	Update time = set "odd" send clock (any multiple of 125 µs: 375 µs, 625 µs ... 3 875 µs)
Update time for RT	
- for send cycle of 250 µs	250 µs to 128 ms
- for send cycle of 500 µs	500 µs to 256 ms
- for send cycle of 1 ms	1 ms to 512 ms
- for send cycle of 2 ms	2 ms to 512 ms
- for send cycle of 4 ms	4 ms to 512 ms
PROFINET IO Device	
Services	
- PG/OP communication	Yes
- S7 routing	Yes
- Isochronous mode	No
- IRT	Yes

Article number	6ES7516-3FN02-0AB0 CPU 1516F-3 PN/DP, 1,5MB Prog, 5MB Data
Services (continued)	
- MRP	Yes; MRP Automanager acc. to IEC 62439-2 Edition 2.0; MRP Manager; MRP Client; max. number of devices in the ring: 50
- MRPD	Yes; Requirement: IRT
- PROFINergy	Yes; per user program
- Shared device	Yes
- Number of IO Controllers with shared device, max.	4
- Asset management record	Yes; per user program
2. Interface	
Interface types	
• Number of ports	1
• integrated switch	No
• RJ 45 (Ethernet)	Yes; X2
Protocols	
• IP protocol	Yes; IPv4
• PROFINET IO Controller	Yes
• PROFINET IO Device	Yes
• SIMATIC communication	Yes
• Open IE communication	Yes; Optionally also encrypted
• Web server	Yes
• Media redundancy	No
PROFINET IO Controller	
Services	
- PG/OP communication	Yes
- S7 routing	Yes
- Isochronous mode	No
- Direct data exchange	No
- IRT	No
- MRP	No
- MRPD	No
- PROFINergy	Yes
- Prioritized startup	No
- Number of connectable IO Devices, max.	32; In total, up to 1 000 distributed I/O devices can be connected via AS-i, PROFIBUS or PROFINET
- Number of connectable IO Devices for RT, max.	32
- of which in line, max.	32
- Number of IO Devices that can be simultaneously activated/deactivated, max.	8; in total across all interfaces
- Number of IO Devices per tool, max.	8
- Updating times	The minimum value of the update time also depends on communication share set for PROFINET IO, on the number of IO devices, and on the quantity of configured user data
Update time for RT	
- for send cycle of 1 ms	1 ms to 512 ms

SIMATIC S7-1500 Advanced Controllers

Central processing units
Fail-safe CPUs

CPU 1516F-3 PN/DP

Technical specifications

Article number	6ES7516-3FN02-0AB0 CPU 1516F-3 PN/DP, 1,5MB Prog, 5MB Data
PROFINET IO Device	
Services	
- PG/OP communication	Yes
- S7 routing	Yes
- Isochronous mode	No
- Open IE communication	Yes
- IRT	No
- MRP	No
- MRPD	No
- PROFINergy	Yes; per user program
- Prioritized startup	No
- Shared device	Yes
- Number of IO Controllers with shared device, max.	4
- Asset management record	Yes; per user program
3. Interface	
Interface types	
• Number of ports	1
• RS 485	Yes; X3
Protocols	
• PROFIBUS DP master	Yes
• PROFIBUS DP slave	No
• SIMATIC communication	Yes
Protocols	
Number of connections	
• Number of connections, max.	256; via integrated interfaces of the CPU and connected CPs / CMs
PROFIBUS DP master	
Services	
- Number of DP slaves	125; In total, up to 1 000 distributed I/O devices can be connected via AS-i, PROFIBUS or PROFINET
OPC UA	
• OPC UA client	Yes
• OPC UA server	Yes; Data access (read, write, subscribe), method call, custom address space
Isochronous mode	
Isochronous operation (application synchronized up to terminal)	Yes; Distributed and central; with minimum OB 6x cycle of 375 µs (distributed) and 1 ms (central)
Supported technology objects	
Motion Control	Yes; Note: The number of axes affects the cycle time of the PLC program; selection guide via the TIA Selection Tool or SIZER
• Number of available Motion Control resources for technology objects	2 400
• Required Motion Control resources	
- per speed-controlled axis	40
- per positioning axis	80
- per synchronous axis	160
- per external encoder	80
- per output cam	20
- per cam track	160
- per probe	40

Article number	6ES7516-3FN02-0AB0 CPU 1516F-3 PN/DP, 1,5MB Prog, 5MB Data
Controller	
• PID_Compact	Yes; Universal PID controller with integrated optimization
• PID_3Step	Yes; PID controller with integrated optimization for valves
• PID-Temp	Yes; PID controller with integrated optimization for temperature
Counting and measuring	
• High-speed counter	Yes
Standards, approvals, certificates	
Highest safety class achievable in safety mode	
Probability of failure (for service life of 20 years and repair time of 100 hours)	
- Low demand mode: PFDavg in accordance with SIL3	< 2.00E-05
- High demand/continuous mode: PFH in accordance with SIL3	< 1.00E-09
Ambient conditions	
Ambient temperature during operation	
• horizontal installation, min.	-25 °C; No condensation
• horizontal installation, max.	60 °C; Display: 50 °C, at an operating temperature of typically 50 °C, the display is switched off
• vertical installation, min.	-25 °C; No condensation
• vertical installation, max.	40 °C; Display: 40 °C, at an operating temperature of typically 40 °C, the display is switched off
Altitude during operation relating to sea level	
• Installation altitude above sea level, max.	5 000 m; Restrictions for installation altitudes > 2 000 m, see manual
Configuration	
Programming	
Programming language	
- LAD	Yes; incl. failsafe
- FBD	Yes; incl. failsafe
- STL	Yes
- SCL	Yes
- GRAPH	Yes
Know-how protection	
• User program protection/password protection	Yes
• Copy protection	Yes
• Block protection	Yes
Access protection	
• Password for display	Yes
• Protection level: Write protection	Yes; Specific write protection both for Standard and for Failsafe
• Protection level: Read/write protection	Yes
• Protection level: Complete protection	Yes
Dimensions	
Width	70 mm
Height	147 mm
Depth	129 mm
Weights	
Weight, approx.	845 g

Ordering data	Article No.	Ordering data	Article No.
CPU 1516F-3 PN/DP Fail-safe CPU, 1.5 MB work memory for program, 5 MB for data, PROFINET IRT interface with 2-port switch, PROFINET RT interface, PROFIBUS interface; SIMATIC Memory Card required	6ES7516-3FN02-0AB0	PROFIBUS FC standard cable GP Standard type with special design for quick mounting, 2-wire, shielded; sold by the meter; max. delivery unit 1 000 m, minimum order quantity 20 m	6XV1830-0EH10
Accessories		PROFIBUS FC robust cable 2-wire, shielded; sold by the meter; max. delivery unit 1 000 m, minimum order quantity 20 m	6XV1830-0JH10
SIMATIC Memory Card		PROFIBUS FC flexible cable 2-wire, shielded; sold by the meter; max. delivery unit 1 000 m, minimum order quantity 20 m	6XV1831-2K
4 MB	6ES7954-8LC03-0AA0	PROFIBUS FC trailing cable 2-wire, shielded; sold by the meter; max. delivery unit 1 000 m, minimum order quantity 20 m	
12 MB	6ES7954-8LE03-0AA0	Sheath color: Petrol	6XV1830-3EH10
24 MB	6ES7954-8LF03-0AA0	Sheath color: Violet	6XV1831-2L
256 MB	6ES7954-8LL03-0AA0	PROFIBUS FC food cable 2-wire, shielded; sold by the meter; max. delivery unit 1 000 m, minimum order quantity 20 m	6XV1830-0GH10
2 GB	6ES7954-8LP02-0AA0	PROFIBUS FC ground cable 2-wire, shielded; sold by the meter; max. delivery unit 1 000 m, minimum order quantity 20 m	6XV1830-3FH10
32 GB	6ES7954-8LT03-0AA0	PROFIBUS FC FRNC cable GP 2-wire, shielded, flame-retardant, with copolymer protective jacket FRNC; sold by the meter; max. delivery unit 1 000 m, minimum order quantity 20 m	6XV1830-0LH10
SIMATIC S7-1500 mounting rail Fixed lengths, with grounding elements		PROFIBUS FastConnect stripping tool Pre-adjusted stripping tool for fast stripping of PROFIBUS FastConnect bus cables	6GK1905-6AA00
• 160 mm	6ES7590-1AB60-0AA0	IE FC RJ45 plugs RJ45 plug connector for Industrial Ethernet with a rugged metal enclosure and integrated insulation displacement contacts for connecting Industrial Ethernet FC installation cables	
• 245 mm	6ES7590-1AC40-0AA0	IE FC RJ45 plug 180 180° cable outlet	
• 482 mm	6ES7590-1AE80-0AA0	1 unit	6GK1901-1BB10-2AA0
• 530 mm	6ES7590-1AF30-0AA0	10 units	6GK1901-1BB10-2AB0
• 830 mm	6ES7590-1AJ30-0AA0	50 units	6GK1901-1BB10-2AE0
For cutting to length by customer, without drill holes; grounding elements must be ordered separately		IE FC TP standard cable GP 2x2 4-wire, shielded TP installation cable for connection to IE FC RJ45 outlet/IE FC RJ45 plug; PROFINET-compatible; with UL approval; sold by the meter; max. delivery unit 1 000 m, minimum order quantity 20 m	6XV1840-2AH10
• 2 000 mm	6ES7590-1BC00-0AA0		
PE connection element for mounting rail 2 000 mm 20 units	6ES7590-5AA00-0AA0		
System power supply For supplying the backplane bus of the S7-1500 PLC			
24 V DC input voltage, power 25 W	6ES7505-0KA00-0AB0		
24/48/60 V DC input voltage, power 60 W	6ES7505-0RA00-0AB0		
24/48/60 V DC input voltage, power 60 W, buffering functionality	6ES7505-0RB00-0AB0		
120/230 V AC input voltage, power 60 W	6ES7507-0RA00-0AB0		
Power plug With coding element for power supply module; spare part, 10 units	6ES7590-8AA00-0AA0		
Load power supply 24 V DC/3 A	6EP1332-4BA00		
24 V DC/8 A	6EP1333-4BA00		
Power supply connector Spare part; for connecting the 24 V DC supply voltage			
• With push-in terminals	6ES7193-4JB00-0AA0		
PROFIBUS FastConnect bus connector RS485 with 90° cable outlet With insulation displacement, max. transmission rate 12 Mbps			
Without PG interface, grounding via control cabinet contact surface; 1 unit	6ES7972-0BA70-0XA0		
With PG interface, grounding via control cabinet contact surface; 1 unit	6ES7972-0BB70-0XA0		

SIMATIC S7-1500 Advanced Controllers

Central processing units

Fail-safe CPUs

CPU 1516F-3 PN/DP

4

Ordering data	Article No.	Article No.
IE FC TP trailing cable 2 x 2 (Type C) 4-wire, shielded TP installation cable for connection to IE FC RJ45 outlet/IE FC RJ45 plug 180/90 for use in cable carrier; PROFINET-compatible; with UL approval; sold by the meter; max. delivery unit 1 000 m, minimum order quantity 20 m	6XV1840-3AH10	
IE FC TP marine cable 2 x 2 (Type B) 4-wire, shielded TP installation cable for connection to IE FC RJ45 outlet/IE FC RJ45 plug 180/90 with marine approval; sold by the meter; max. delivery unit 1 000 m, minimum order quantity 20 m	6XV1840-4AH10	
IE FC stripping tool Pre-adjusted stripping tool for fast stripping of Industrial Ethernet FC cables	6GK1901-1GA00	
Display module 70 mm For CPU 1515-2 PN, CPU 1516-3 PN/DP, CPU 1515F-2 PN and CPU 1516F-3 PN/DP; spare part	6ES7591-1BB00-0AA0	
Cover 70 mm For CPU 1515-2 PN, CPU 1516-3 PN/DP, CPU 1515F-2 PN and CPU 1516F-3 PN/DP; spare part	6ES7591-4BB00-0AA0	
STEP 7 Professional V16 <u>Target system:</u> SIMATIC S7-1200, S7-1500, S7-300, S7-400, WinAC <u>Requirement:</u> Windows 7 Professional SP1 Windows 7 Enterprise SP1 Windows 7 Ultimate SP1 Windows 10 Professional Version 1809, 1903 Windows 10 Enterprise Version 1809, 1903 Windows 10 IoT Enterprise 2015 LTSB Windows 10 IoT Enterprise 2016 LTSB Windows 10 IoT Enterprise 2019 LTSC Windows Server 2012 R2 StdE (full installation) Windows Server 2016 Standard (full installation) Windows Server 2019 Standard (full installation) <u>Type of delivery:</u> en, de, fr, it, es, zh STEP 7 Professional V16, floating license STEP 7 Professional V16, floating license, software download including license key ¹⁾ E-mail address required for delivery	6ES7822-1AA06-0YA5 6ES7822-1AE06-0YA5	
STEP 7 Safety Advanced V16 <u>Task:</u> Engineering tool for configuring and programming fail-safe user programs for SIMATIC S7-1200 FC, S7-1500F, S7-1500F Software Controller, S7-300F, S7-400F, WinAC RTX F, ET 200SP F Controller and the fail-safe ET 200SP, ET 200MP, ET 200S, ET 200M, ET 200iSP, ET 200pro and ET 200eco I/O <u>Requirement:</u> STEP 7 Professional V16 <u>Note:</u> As from TIA Portal V16, the SIMATIC STEP 7 Safety software is an integral part of the SIMATIC STEP 7 product setup. The functionality of SIMATIC STEP 7 Safety is activated by means of the license key supplied in each case. Floating license for 1 user; license key on USB flash drive Floating license for 1 user, license key for download ¹⁾ ; e-mail address required for delivery		6ES7833-1FA16-0YA5 6ES7833-1FA16-0YH5 6ES7998-8XC01-8YE0 6ES7998-8XC01-8YE2
SIMATIC Manual Collection Electronic manuals on DVD, multilingual: LOGO!, SIMADYN, SIMATIC bus components, SIMATIC C7, SIMATIC distributed I/O, SIMATIC HMI, SIMATIC sensors, SIMATIC NET, SIMATIC PC-based automation, SIMATIC PCS 7, SIMATIC PG/PC, SIMATIC S7, SIMATIC software, SIMATIC TDC		6ES7998-8XC01-8YE0
SIMATIC Manual Collection update service for 1 year Current Manual Collection DVD and the three subsequent updates		6ES7998-8XC01-8YE2

¹⁾ For up-to-date information and download availability, see: <http://www.siemens.com/tia-online-software-delivery>

Overview



- 16 and 32-channel digital input modules
- For flexible adaptation of the controller to the corresponding task
- For subsequent expansion of the system with additional inputs

Note:

SIPLUS extreme products are based on SIMATIC standard products. The contents listed here were taken from the respective standard products. SIPLUS extreme-specific information was added.

Technical specifications

Article number	6AG1521-1BH00-7AB0	6AG1521-1BL00-7AB0	6AG1521-1BH50-7AA0	6AG1521-1FH00-7AA0	6AG1521-7EH00-7AB0
Based on	6ES7521-1BH00-0AB0 SIPLUS S7-1500 DI 16X24VDC HF	6ES7521-1BL00-0AB0 SIPLUS S7-1500 DI 32X24VDC HF	6ES7521-1BH50-0AA0 SIPLUS S7-1500 DI 16X24VDC SRC BA	6ES7521-1FH00-0AA0 SIPLUS S7-1500 DI 16X230VAC BA	6ES7521-7EH00-0AB0 SIPLUS S7-1500 DI 48VUC/125VDC HF
Ambient conditions					
Ambient temperature during operation					
• horizontal installation, min.	-40 °C; = Tmin (incl. condensation/frost)	-40 °C; = Tmin (incl. condensation/frost)	-40 °C; = Tmin (incl. condensation/frost)	-40 °C; = Tmin (incl. condensation/frost)	-40 °C; = Tmin (incl. condensation/frost)
• horizontal installation, max.	70 °C; = Tmax	70 °C; = Tmax; > +60 °C number of simultaneously controllable inputs max. 16	70 °C; = Tmax; > +60 °C number of simultaneously controllable inputs max. 8	70 °C; = Tmax; > +60 °C number of simultaneously controllable inputs max. 8	70 °C; = Tmax; see Derating BasedOn (e.g. manual), additionally Tmax > 60 °C max. 4 inputs (no adjacent points)
• vertical installation, min.	-40 °C; = Tmin	-40 °C; = Tmin	-40 °C; = Tmin	-40 °C; = Tmin	-40 °C; = Tmin
• vertical installation, max.	40 °C; = Tmax	40 °C; = Tmax	40 °C; = Tmax	40 °C; = Tmax	40 °C; = Tmax
Altitude during operation relating to sea level					
• Installation altitude above sea level, max.	5 000 m	5 000 m	5 000 m	2 000 m	2 000 m
• Ambient air temperature-barometric pressure-altitude	Tmin ... Tmax at 1 140 hPa ... 795 hPa (-1 000 m ... +2 000 m) // Tmin ... (Tmax - 10 K) at 795 hPa ... 658 hPa (+2 000 m ... +3 500 m) // Tmin ... (Tmax -20 K) at 658 hPa ... 540 hPa (+3 500 m ... +5 000 m)	Tmin ... Tmax at 1 140 hPa ... 795 hPa (-1 000 m ... +2 000 m) // Tmin ... (Tmax - 10 K) at 795 hPa ... 658 hPa (+2 000 m ... +3 500 m) // Tmin ... (Tmax -20 K) at 658 hPa ... 540 hPa (+3 500 m ... +5 000 m)	Tmin ... Tmax at 1 140 hPa ... 795 hPa (-1 000 m ... +2 000 m) // Tmin ... (Tmax - 10 K) at 795 hPa ... 658 hPa (+2 000 m ... +3 500 m) // Tmin ... (Tmax -20 K) at 658 hPa ... 540 hPa (+3 500 m ... +5 000 m)	Tmin ... Tmax at 1 140 hPa ... 795 hPa (-1 000 m ... +2 000 m)	Tmin ... Tmax at 1 140 hPa ... 795 hPa (-1 000 m ... +2 000 m)
Relative humidity					
• With condensation, tested in accordance with IEC 60068-2-38, max.	100 %; RH incl. condensation/frost (no commissioning under condensation conditions)	100 %; RH incl. condensation/frost (no commissioning under condensation conditions)	100 %; RH incl. condensation/frost (no commissioning under condensation conditions)	100 %; RH incl. condensation/frost (no commissioning under condensation conditions)	100 %; RH incl. condensation / frost (no commissioning in bedewed state), horizontal installation
Resistance					
Coolants and lubricants					
- Resistant to commercially available coolants and lubricants	Yes; Incl. diesel and oil droplets in the air	Yes; Incl. diesel and oil droplets in the air	Yes; Incl. diesel and oil droplets in the air	Yes; Incl. diesel and oil droplets in the air	Yes; Incl. diesel and oil droplets in the air

SIMATIC S7-1500 Advanced Controllers

I/O modules

SIPLUS digital modules

SIPLUS SM 521 digital input modules

Technical specifications

Article number	6AG1521-1BH00-7AB0	6AG1521-1BL00-7AB0	6AG1521-1BH50-7AA0	6AG1521-1FH00-7AA0	6AG1521-7EH00-7AB0
Based on	6ES7521-1BH00-0AB0 SIPLUS S7-1500 DI 16X24VDC HF	6ES7521-1BL00-0AB0 SIPLUS S7-1500 DI 32X24VDC HF	6ES7521-1BH50-0AA0 SIPLUS S7-1500 DI 16X24VDC SRC BA	6ES7521-1FH00-0AA0 SIPLUS S7-1500 DI 16X230VAC BA	6ES7521-7EH00-0AB0 SIPLUS S7-1500 DI 48VUC/125VDC HF
Use in stationary industrial systems					
- to biologically active substances according to EN 60721-3-3	Yes; Class 3B2 mold, fungus and dry rot spores (with the exception of fauna); Class 3B3 on request	Yes; Class 3B2 mold, fungus and dry rot spores (with the exception of fauna); Class 3B3 on request	Yes; Class 3B2 mold, fungus and dry rot spores (with the exception of fauna); Class 3B3 on request	Yes; Class 3B2 mold, fungus and dry rot spores (with the exception of fauna); Class 3B3 on request	Yes; Class 3B2 mold, fungus and dry rot spores (with the exception of fauna); Class 3B3 on request
- to chemically active substances according to EN 60721-3-3	Yes; Class 3C4 (RH < 75 %) incl. salt spray acc. to EN 60068-2-52 (severity degree 3); *	Yes; Class 3C4 (RH < 75 %) incl. salt spray acc. to EN 60068-2-52 (severity degree 3); *	Yes; Class 3C4 (RH < 75 %) incl. salt spray acc. to EN 60068-2-52 (severity degree 3); *	Yes; Class 3C4 (RH < 75 %) incl. salt spray acc. to EN 60068-2-52 (severity degree 3); *	Yes; Class 3C4 (RH < 75 %) incl. salt spray acc. to EN 60068-2-52 (severity degree 3); *
- to mechanically active substances according to EN 60721-3-3	Yes; Class 3S4 incl. sand, dust; *	Yes; Class 3S4 incl. sand, dust; *	Yes; Class 3S4 incl. sand, dust; *	Yes; Class 3S4 incl. sand, dust; *	Yes; Class 3S4 incl. sand, dust; *
Use on ships/at sea					
- to biologically active substances according to EN 60721-3-6	Yes; Class 6B2 mold and fungal spores (excluding fauna); Class 6B3 on request	Yes; Class 6B2 mold and fungal spores (excluding fauna); Class 6B3 on request	Yes; Class 6B2 mold and fungal spores (excluding fauna); Class 6B3 on request	Yes; Class 6B2 mold and fungal spores (excluding fauna); Class 6B3 on request	Yes; Class 6B2 mold and fungal spores (excluding fauna); Class 6B3 on request
- to chemically active substances according to EN 60721-3-6	Yes; Class 6C3 (RH < 75 %) incl. salt spray acc. to EN 60068-2-52 (severity degree 3); *	Yes; Class 6C3 (RH < 75 %) incl. salt spray acc. to EN 60068-2-52 (severity degree 3); *	Yes; Class 6C3 (RH < 75 %) incl. salt spray acc. to EN 60068-2-52 (severity degree 3); *	Yes; Class 6C3 (RH < 75 %) incl. salt spray acc. to EN 60068-2-52 (severity degree 3); *	Yes; Class 6C3 (RH < 75 %) incl. salt spray acc. to EN 60068-2-52 (severity degree 3); *
- to mechanically active substances according to EN 60721-3-6	Yes; Class 6S3 incl. sand, dust; *	Yes; Class 6S3 incl. sand, dust; *	Yes; Class 6S3 incl. sand, dust; *	Yes; Class 6S3 incl. sand, dust; *	Yes; Class 6S3 incl. sand, dust; *
Usage in industrial process technology					
- Against chemically active substances acc. to EN 60654-4	Yes; Class 3 (excluding trichlorethylene)	Yes; Class 3 (excluding trichlorethylene)	Yes; Class 3 (excluding trichlorethylene)	Yes; Class 3 (excluding trichlorethylene)	Yes; Class 3 (excluding trichlorethylene)
- Environmental conditions for process, measuring and control systems acc. to ANSI/ISA-71.04	Yes; Level GX group A/B (excluding trichlorethylene; harmful gas concentrations up to the limits of EN 60721-3-3 class 3C4 permissible); level LC3 (salt spray) and level LB3 (oil)	Yes; Level GX group A/B (excluding trichlorethylene; harmful gas concentrations up to the limits of EN 60721-3-3 class 3C4 permissible); level LC3 (salt spray) and level LB3 (oil)	Yes; Level GX group A/B (excluding trichlorethylene; harmful gas concentrations up to the limits of EN 60721-3-3 class 3C4 permissible); level LC3 (salt spray) and level LB3 (oil)	Yes; Level GX group A/B (excluding trichlorethylene; harmful gas concentrations up to the limits of EN 60721-3-3 class 3C4 permissible); level LC3 (salt spray) and level LB3 (oil)	Yes; Level GX group A/B (excluding trichlorethylene; harmful gas concentrations up to the limits of EN 60721-3-3 class 3C4 permissible); level LC3 (salt spray) and level LB3 (oil)
Remark					
- Note regarding classification of environmental conditions acc. to EN 60721, EN 60654-4 and ANSI/ISA-71.04	* The supplied plug covers must remain in place over the unused interfaces during operation!	* The supplied plug covers must remain in place over the unused interfaces during operation!	* The supplied plug covers must remain in place over the unused interfaces during operation!	* The supplied plug covers must remain in place over the unused interfaces during operation!	* The supplied plug covers must remain in place over the unused interfaces during operation!

Technical specifications

Article number	6AG1521-1BH00-7AB0	6AG1521-1BL00-7AB0	6AG1521-1BH50-7AA0	6AG1521-1FH00-7AA0	6AG1521-7EH00-7AB0
Based on	6ES7521-1BH00-0AB0 SIPLUS S7-1500 DI 16X24VDC HF	6ES7521-1BL00-0AB0 SIPLUS S7-1500 DI 32X24VDC HF	6ES7521-1BH50-0AA0 SIPLUS S7-1500 DI 16X24VDC SRC BA	6ES7521-1FH00-0AA0 SIPLUS S7-1500 DI 16X230VAC BA	6ES7521-7EH00-0AB0 SIPLUS S7-1500 DI 48VUC/125VDC HF
Conformal coating					
<ul style="list-style-type: none"> Coatings for printed circuit board assemblies acc. to EN 61086 Protection against fouling acc. to EN 60664-3 Military testing according to MIL-I-46058C, Amendment 7 Qualification and Performance of Electrical Insulating Compound for Printed Board Assemblies according to IPC-CC-830A 	<ul style="list-style-type: none"> Yes; Class 2 for high reliability Yes; Type 1 protection Yes; Discoloration of coating possible during service life Yes; Conformal coating, Class A 	<ul style="list-style-type: none"> Yes; Class 2 for high reliability Yes; Type 1 protection Yes; Discoloration of coating possible during service life Yes; Conformal coating, Class A 	<ul style="list-style-type: none"> Yes; Class 2 for high reliability Yes; Type 1 protection Yes; Discoloration of coating possible during service life Yes; Conformal coating, Class A 	<ul style="list-style-type: none"> Yes; Class 2 for high availability Yes; Type 1 protection Yes; Discoloration of coating possible during service life Yes; Conformal coating, Class A 	<ul style="list-style-type: none"> Yes; Class 2 for high availability Yes; Type 1 protection Yes; Discoloration of coating possible during service life Yes; Conformal coating, Class A
Dimensions					
Width	35 mm	35 mm	35 mm	35 mm	
Height	147 mm	147 mm	147 mm	147 mm	
Depth	129 mm	129 mm	129 mm	129 mm	
Weights					
Weight, approx.	240 g	260 g	230 g	200 g	

Ordering data

Article No.

SIPLUS SM 521 digital input modules

(Extended temperature range and exposure to environmental substances)

16 inputs, 24 V DC, isolated, parameterizable diagnostics and hardware interrupts

6AG1521-1BH00-7AB0

32 inputs, 24 V DC, isolated, parameterizable diagnostics and hardware interrupts

6AG1521-1BL00-7AB0

16 inputs, 24 V DC, isolated, input delay 3.2 ms

6AG1521-1BH50-7AA0

16 inputs, 230 V AC, isolated, input delay 20 ms

6AG1521-1FH00-7AA0

16 inputs, 48 ... 125 V UC, input delay 0.05 ... 20 ms, parameterizable diagnostics and hardware interrupts

6AG1521-7EH00-7AB0

Accessories

See SIMATIC S7-1500 SM 521 digital input modules, catalog ST 70 · 2019, page 4/89

SIMATIC S7-1500 Advanced Controllers

I/O modules

SIPLUS digital modules

SIPLUS SM 522 digital output modules

Overview



- 8, 16 and 32-channel digital output modules
- For flexible adaptation of the controller to the corresponding task
- For subsequent expansion of the system with additional outputs

Note:

SIPLUS extreme products are based on SIMATIC standard products. The contents listed here were taken from the respective standard products. SIPLUS extreme-specific information has been added.

Technical specifications

Article number	6AG1522-1BF00-7AB0	6AG1522-1BH01-7AB0	6AG1522-1BL01-7AB0	6AG1522-5EH00-7AB0
Based on	6ES7522-1BF00-0AB0 SIPLUS S7-1500 DQ 8X24VDC/2A HF	6ES7522-1BH01-0AB0 SIPLUS S7-1500 DQ 16X24VDC/0.5A HF	6ES7522-1BL01-0AB0 SIPLUS S7-1500 DQ 32X24VDC/0.5A HF	6ES7522-5EH00-0AB0 SIPLUS S7-1500 DQ 16x48VUC/125VDC ST
Ambient conditions				
Ambient temperature during operation				
• horizontal installation, min.	-40 °C; = Tmin (incl. condensation/frost)	-40 °C; = Tmin (incl. condensation/frost)	-40 °C; = Tmin (incl. condensation/frost)	-40 °C; = Tmin (incl. condensation/frost)
• horizontal installation, max.	70 °C; = Tmax; > +60 °C Number of simultaneously controllable outputs max. 8x 0.5 A, max. total current per group 2 A	70 °C; = Tmax; see Derating BasedOn (e.g. manual), additionally Tmax > 60 °C max. aggregate current 2 A per group	70 °C; = Tmax; see Derating BasedOn (e.g. manual), additionally Tmax > 60 °C max. aggregate current 2 A per group	70 °C; = Tmax; > +60 °C max. 0.25 A per output
• vertical installation, min.	-40 °C; = Tmin	-40 °C; = Tmin	-40 °C; = Tmin	-40 °C; = Tmin
• vertical installation, max.	40 °C; = Tmax	40 °C; = Tmax	40 °C; = Tmax	40 °C; = Tmax
Altitude during operation relating to sea level				
• Installation altitude above sea level, max.	5 000 m	5 000 m	5 000 m	2 000 m
• Ambient air temperature-barometric pressure-altitude	Tmin ... Tmax at 1 140 hPa ... 795 hPa (-1 000 m ... +2 000 m) // Tmin ... (Tmax - 10 K) at 795 hPa ... 658 hPa (+2 000 m ... +3 500 m) // Tmin ... (Tmax -20 K) at 658 hPa ... 540 hPa (+3 500 m ... +5 000 m)	Tmin ... Tmax at 1 140 hPa ... 795 hPa (-1 000 m ... +2 000 m) // Tmin ... (Tmax - 10 K) at 795 hPa ... 658 hPa (+2 000 m ... +3 500 m) // Tmin ... (Tmax -20 K) at 658 hPa ... 540 hPa (+3 500 m ... +5 000 m)	Tmin ... Tmax at 1 140 hPa ... 795 hPa (-1 000 m ... +2 000 m) // Tmin ... (Tmax - 10 K) at 795 hPa ... 658 hPa (+2 000 m ... +3 500 m) // Tmin ... (Tmax -20 K) at 658 hPa ... 540 hPa (+3 500 m ... +5 000 m)	Tmin ... Tmax at 1 140 hPa ... 795 hPa (-1 000 m ... +2 000 m)
Relative humidity				
• With condensation, tested in accordance with IEC 60068-2-38, max.	100 %; RH incl. condensation/frost (no commissioning under condensation conditions)	100 %; RH incl. condensation / frost (no commissioning in bedewed state), horizontal installation	100 %; RH incl. condensation / frost (no commissioning in bedewed state), horizontal installation	100 %; RH incl. condensation / frost (no commissioning in bedewed state), horizontal installation
Resistance				
Coolants and lubricants				
- Resistant to commercially available coolants and lubricants	Yes; Incl. diesel and oil droplets in the air	Yes; Incl. diesel and oil droplets in the air	Yes; Incl. diesel and oil droplets in the air	Yes; Incl. diesel and oil droplets in the air
Use in stationary industrial systems				
- to biologically active substances according to EN 60721-3-3	Yes; Class 3B2 mold, fungus and dry rot spores (with the exception of fauna); Class 3B3 on request	Yes; Class 3B2 mold, fungus and dry rot spores (with the exception of fauna); Class 3B3 on request	Yes; Class 3B2 mold, fungus and dry rot spores (with the exception of fauna); Class 3B3 on request	Yes; Class 3B2 mold, fungus and dry rot spores (with the exception of fauna); Class 3B3 on request
- to chemically active substances according to EN 60721-3-3	Yes; Class 3C4 (RH < 75 %) incl. salt spray acc. to EN 60068-2-52 (severity degree 3); *	Yes; Class 3C4 (RH < 75 %) incl. salt spray acc. to EN 60068-2-52 (severity degree 3); *	Yes; Class 3C4 (RH < 75 %) incl. salt spray acc. to EN 60068-2-52 (severity degree 3); *	Yes; Class 3C4 (RH < 75 %) incl. salt spray acc. to EN 60068-2-52 (severity degree 3); *
- to mechanically active substances according to EN 60721-3-3	Yes; Class 3S4 incl. sand, dust, *	Yes; Class 3S4 incl. sand, dust, *	Yes; Class 3S4 incl. sand, dust, *	Yes; Class 3S4 incl. sand, dust, *

Technical specifications

Article number	6AG1522-1BF00-7AB0	6AG1522-1BH01-7AB0	6AG1522-1BL01-7AB0	6AG1522-5EH00-7AB0
Based on	6ES7522-1BF00-0AB0 SIPLUS S7-1500 DQ 8X24VDC/2A HF	6ES7522-1BH01-0AB0 SIPLUS S7-1500 DQ 16X24VDC/0.5A HF	6ES7522-1BL01-0AB0 SIPLUS S7-1500 DQ 32X24VDC/0.5A HF	6ES7522-5EH00-0AB0 SIPLUS S7-1500 DQ 16x48VUC/125VDC ST
Use on ships/at sea				
- to biologically active substances according to EN 60721-3-6	Yes; Class 6B2 mold and fungal spores (excluding fauna); Class 6B3 on request	Yes; Class 6B2 mold and fungal spores (excluding fauna); Class 6B3 on request	Yes; Class 6B2 mold and fungal spores (excluding fauna); Class 6B3 on request	Yes; Class 6B2 mold and fungal spores (excluding fauna); Class 6B3 on request
- to chemically active substances according to EN 60721-3-6	Yes; Class 6C3 (RH < 75 %) incl. salt spray acc. to EN 60068-2-52 (severity degree 3); *	Yes; Class 6C3 (RH < 75 %) incl. salt spray acc. to EN 60068-2-52 (severity degree 3); *	Yes; Class 6C3 (RH < 75 %) incl. salt spray acc. to EN 60068-2-52 (severity degree 3); *	Yes; Class 6C3 (RH < 75 %) incl. salt spray acc. to EN 60068-2-52 (severity degree 3); *
- to mechanically active substances according to EN 60721-3-6	Yes; Class 6S3 incl. sand, dust; *	Yes; Class 6S3 incl. sand, dust; *	Yes; Class 6S3 incl. sand, dust; *	Yes; Class 6S3 incl. sand, dust; *
Usage in industrial process technology				
- Against chemically active substances acc. to EN 60654-4	Yes; Class 3 (excluding trichlorethylene)	Yes; Class 3 (excluding trichlorethylene)	Yes; Class 3 (excluding trichlorethylene)	Yes; Class 3 (excluding trichlorethylene)
- Environmental conditions for process, measuring and control systems acc. to ANSI/ISA-71.04	Yes; Level GX group A/B (excluding trichlorethylene; harmful gas concentrations up to the limits of EN 60721-3-3 class 3C4 permissible); level LC3 (salt spray) and level LB3 (oil)	Yes; Level GX group A/B (excluding trichlorethylene; harmful gas concentrations up to the limits of EN 60721-3-3 class 3C4 permissible); level LC3 (salt spray) and level LB3 (oil)	Yes; Level GX group A/B (excluding trichlorethylene; harmful gas concentrations up to the limits of EN 60721-3-3 class 3C4 permissible); level LC3 (salt spray) and level LB3 (oil)	Yes; Level GX group A/B (excluding trichlorethylene; harmful gas concentrations up to the limits of EN 60721-3-3 class 3C4 permissible); level LC3 (salt spray) and level LB3 (oil)
Remark				
- Note regarding classification of environmental conditions acc. to EN 60721, EN 60654-4 and ANSI/ISA-71.04	* The supplied plug covers must remain in place over the unused interfaces during operation!	* The supplied plug covers must remain in place over the unused interfaces during operation!	* The supplied plug covers must remain in place over the unused interfaces during operation!	* The supplied plug covers must remain in place over the unused interfaces during operation!
Conformal coating				
• Coatings for printed circuit board assemblies acc. to EN 61086	Yes; Class 2 for high reliability	Yes; Class 2 for high reliability	Yes; Class 2 for high reliability	Yes; Class 2 for high reliability
• Protection against fouling acc. to EN 60664-3	Yes; Type 1 protection	Yes; Type 1 protection	Yes; Type 1 protection	Yes; Type 1 protection
• Military testing according to MIL-I-46058C, Amendment 7	Yes; Discoloration of coating possible during service life	Yes; Discoloration of coating possible during service life	Yes; Discoloration of coating possible during service life	Yes; Discoloration of coating possible during service life
• Qualification and Performance of Electrical Insulating Compound for Printed Board Assemblies according to IPC-CC-830A	Yes; Conformal coating, Class A	Yes; Conformal coating, Class A	Yes; Conformal coating, Class A	Yes; Conformal coating, Class A
Article number	6AG1522-5HH00-7AB0	6AG1522-5HF00-2AB0	6AG1522-5FF00-7AB0	6AG1522-5FH00-7AB0
Based on	6ES7522-5HH00-0AB0 SIPLUS S7-1500 16DQ 230VAC 2A RLY	6ES7522-5HF00-0AB0 SIPLUS S7-1500 DQ 8X230VAC/5A ST (RELAY)	6ES7522-5FF00-0AB0 SIPLUS S7-1500 DQ 8X230VAC/2A ST (TRIAC)	6ES7522-5FH00-0AB0 SIPLUS S7-1500 16DQ 230VAC 1A ST TRIAC
Ambient conditions				
Ambient temperature during operation				
• horizontal installation, min.	-40 °C; = Tmin (incl. condensation/frost); start-up @ -25 °C	-25 °C; = Tmin (incl. condensation/frost)	-40 °C; = Tmin (incl. condensation/frost)	-40 °C; = Tmin (incl. condensation/frost); start-up @ -25 °C
• horizontal installation, max.	70 °C; = Tmax; see Derating BasedOn (e.g. manual), additionally Tmax > 60 °C max. 8 outputs (no adjacent points)	60 °C; = Tmax	70 °C; = Tmax; > +60 °C number of simultaneously controllable outputs max. 8x 0.25 A, max. total current 2 A	70 °C; = Tmax; see Derating BasedOn (e.g. manual), additionally Tmax > 60 °C max. 4 A aggregate current per module, max. 0.25 A per output
• vertical installation, min.	-40 °C; = Tmin; Startup @ -25 °C	-25 °C; = Tmin	-40 °C; = Tmin	-40 °C; = Tmin; Startup @ -25 °C
• vertical installation, max.	40 °C	40 °C; = Tmax	40 °C; = Tmax	60 °C
Altitude during operation relating to sea level				
• Installation altitude above sea level, max.	2 000 m	2 000 m	2 000 m	2 000 m
• Ambient air temperature-barometric pressure-altitude	Tmin ... Tmax at 1 140 hPa ... 795 hPa (-1 000 m ... +2 000 m)	Tmin ... Tmax at 1 140 hPa ... 795 hPa (-1 000 m ... +2 000 m)	Tmin ... Tmax at 1 140 hPa ... 795 hPa (-1 000 m ... +2 000 m)	Tmin ... Tmax at 1 140 hPa ... 795 hPa (-1 000 m ... +2 000 m)

SIMATIC S7-1500 Advanced Controllers

I/O modules

SIPLUS digital modules

SIPLUS SM 522 digital output modules

Technical specifications

Article number	6AG1522-5HH00-7AB0	6AG1522-5HF00-2AB0	6AG1522-5FF00-7AB0	6AG1522-5FH00-7AB0
Based on	6ES7522-5HH00-0AB0 SIPLUS S7-1500 16DQ 230VAC 2A RLY	6ES7522-5HF00-0AB0 SIPLUS S7-1500 DQ 8X230VAC/5A ST (RELAY)	6ES7522-5FF00-0AB0 SIPLUS S7-1500 DQ 8X230VAC/2A ST (TRIAC)	6ES7522-5FH00-0AB0 SIPLUS S7-1500 16DQ 230VAC 1A ST TRIAC
Relative humidity	100 %; RH incl. condensation / frost (no commissioning in bedewed state), horizontal installation	100 %; RH incl. condensation/frost (no commissioning under condensation conditions)	100 %; RH incl. condensation/frost (no commissioning under condensation conditions)	100 %; RH incl. condensation / frost (no commissioning in bedewed state), horizontal installation
Resistance				
Coolants and lubricants				
- Resistant to commercially available coolants and lubricants	Yes; Incl. diesel and oil droplets in the air	Yes; Incl. diesel and oil droplets in the air	Yes; Incl. diesel and oil droplets in the air	Yes; Incl. diesel and oil droplets in the air
Use in stationary industrial systems				
- to biologically active substances according to EN 60721-3-3	Yes; Class 3B2 mold, fungus and dry rot spores (with the exception of fauna); Class 3B3 on request	Yes; Class 3B2 mold, fungus and dry rot spores (with the exception of fauna); Class 3B3 on request	Yes; Class 3B2 mold, fungus and dry rot spores (with the exception of fauna); Class 3B3 on request	Yes; Class 3B2 mold, fungus and dry rot spores (with the exception of fauna); Class 3B3 on request
- to chemically active substances according to EN 60721-3-3	Yes; Class 3C4 (RH < 75 %) incl. salt spray acc. to EN 60068-2-52 (severity degree 3); *	Yes; Class 3C4 (RH < 75 %) incl. salt spray acc. to EN 60068-2-52 (severity degree 3); *	Yes; Class 3C4 (RH < 75 %) incl. salt spray acc. to EN 60068-2-52 (severity degree 3); *	Yes; Class 3C4 (RH < 75 %) incl. salt spray acc. to EN 60068-2-52 (severity degree 3); *
- to mechanically active substances according to EN 60721-3-3	Yes; Class 3S4 incl. sand, dust; *	Yes; Class 3S4 incl. sand, dust; *	Yes; Class 3S4 incl. sand, dust; *	Yes; Class 3S4 incl. sand, dust; *
Use on ships/at sea				
- to biologically active substances according to EN 60721-3-6	Yes; Class 6B2 mold and fungal spores (excluding fauna); Class 6B3 on request	Yes; Class 6B2 mold and fungal spores (excluding fauna); Class 6B3 on request	Yes; Class 6B2 mold and fungal spores (excluding fauna); Class 6B3 on request	Yes; Class 6B2 mold and fungal spores (excluding fauna); Class 6B3 on request
- to chemically active substances according to EN 60721-3-6	Yes; Class 6C3 (RH < 75 %) incl. salt spray acc. to EN 60068-2-52 (severity degree 3); *	Yes; Class 6C3 (RH < 75 %) incl. salt spray acc. to EN 60068-2-52 (severity degree 3); *	Yes; Class 6C3 (RH < 75 %) incl. salt spray acc. to EN 60068-2-52 (severity degree 3); *	Yes; Class 6C3 (RH < 75 %) incl. salt spray acc. to EN 60068-2-52 (severity degree 3); *
- to mechanically active substances according to EN 60721-3-6	Yes; Class 6S3 incl. sand, dust; *	Yes; Class 6S3 incl. sand, dust; *	Yes; Class 6S3 incl. sand, dust; *	Yes; Class 6S3 incl. sand, dust; *
Usage in industrial process technology				
- Against chemically active substances acc. to EN 60654-4	Yes; Class 3 (excluding trichlorethylene)	Yes; Class 3 (excluding trichlorethylene)	Yes; Class 3 (excluding trichlorethylene)	Yes; Class 3 (excluding trichlorethylene)
- Environmental conditions for process, measuring and control systems acc. to ANSI/ISA-71.04	Yes; Level GX group A/B (excluding trichlorethylene; harmful gas concentrations up to the limits of EN 60721-3-3 class 3C4 permissible); level LC3 (salt spray) and level LB3 (oil)	Yes; Level GX group A/B (excluding trichlorethylene; harmful gas concentrations up to the limits of EN 60721-3-3 class 3C4 permissible); level LC3 (salt spray) and level LB3 (oil)	Yes; Level GX group A/B (excluding trichlorethylene; harmful gas concentrations up to the limits of EN 60721-3-3 class 3C4 permissible); level LC3 (salt spray) and level LB3 (oil)	Yes; Level GX group A/B (excluding trichlorethylene; harmful gas concentrations up to the limits of EN 60721-3-3 class 3C4 permissible); level LC3 (salt spray) and level LB3 (oil)
Remark				
- Note regarding classification of environmental conditions acc. to EN 60721, EN 60654-4 and ANSI/ISA-71.04	* The supplied plug covers must remain in place over the unused interfaces during operation!	* The supplied plug covers must remain in place over the unused interfaces during operation!	* The supplied plug covers must remain in place over the unused interfaces during operation!	* The supplied plug covers must remain in place over the unused interfaces during operation!
Conformal coating				
• Coatings for printed circuit board assemblies acc. to EN 61086	Yes; Class 2 for high reliability	Yes; Class 2 for high reliability	Yes; Class 2 for high reliability	Yes; Class 2 for high reliability
• Protection against fouling acc. to EN 60664-3	Yes; Type 1 protection	Yes; Type 1 protection	Yes; Type 1 protection	Yes; Type 1 protection
• Military testing according to MIL-I-46058C, Amendment 7	Yes; Discoloration of coating possible during service life	Yes; Discoloration of coating possible during service life	Yes; Discoloration of coating possible during service life	Yes; Discoloration of coating possible during service life
• Qualification and Performance of Electrical Insulating Compound for Printed Board Assemblies according to IPC-CC-830A	Yes; Conformal coating, Class A	Yes; Conformal coating, Class A	Yes; Conformal coating, Class A	Yes; Conformal coating, Class A

Ordering data**Article No.****SIPLUS SM 522 digital output modules**

(Extended temperature range and exposure to environmental substances)

8 outputs, 24 V DC; 2 A, isolated	6AG1522-1BF00-7AB0
16 outputs, 24 V DC; 0.5 A, isolated	6AG1522-1BH01-7AB0
32 outputs, 24 V DC; 0.5 A, isolated	6AG1522-1BL01-7AB0
8 relay outputs, 230 V AC, 5 A	6AG1522-5HF00-2AB0
16 relay outputs, 230 V AC, 2 A	6AG1522-5HH00-7AB0
8 outputs (triac), 230 V AC, 2 A	6AG1522-5FF00-7AB0
16 outputs (triac), 230 V AC, 1 A	6AG1522-5FH00-7AB0
16 outputs, 24 ... 48 V UC, 125 V DC, 0.5 A, isolated	6AG1522-5EH00-7AB0

Accessories

See SIMATIC S7-1500 SM 522 digital output modules, catalog ST 70 · 2019, page 4/97

SIMATIC S7-1500 Advanced Controllers

I/O modules

SIPLUS analog modules

SIPLUS SM 531 analog input modules

Overview



- 8-channel analog input modules
- Optionally with extremely short conversion times
- For the connection of analog sensors without additional amplifiers
- Even solves more complex automation tasks

Note:

SIPLUS extreme products are based on SIMATIC standard products. The contents listed here were taken from the respective standard products. SIPLUS extreme-specific information was added.

Technical specifications

Article number	6AG1531-7NF10-7AB0	6AG1531-7KF00-7AB0	6AG1531-7NF00-7AB0	6AG1531-7PF00-4AB0
Based on	6ES7531-7NF10-0AB0	6ES7531-7KF00-0AB0	6ES7531-7NF00-0AB0	6ES7531-7PF00-0AB0
	SIPLUS S7-1500 AI 8XU/I HS	SIPLUS S7-1500 AI 8XU/I/RTD/TC ST	SIPLUS S7-1500 AI 8XU/I HF	SIPLUS S7-1500 AI 8XU/R/RTD/TC HF
Ambient conditions				
Ambient temperature during operation				
• horizontal installation, min.	-40 °C; = Tmin (incl. condensation/frost)	-40 °C; = Tmin (incl. condensation/frost)	-40 °C; = Tmin (incl. condensation/frost)	0 °C; = Tmin (incl. condensation/frost)
• horizontal installation, max.	70 °C; = Tmax	70 °C; = Tmax	70 °C; = Tmax	60 °C; = Tmax
• vertical installation, min.	-40 °C; = Tmin	-40 °C; = Tmin	-40 °C; = Tmin	0 °C; = Tmin
• vertical installation, max.	40 °C; = Tmax	40 °C; = Tmax	40 °C; = Tmax	40 °C; = Tmax
Altitude during operation relating to sea level				
• Installation altitude above sea level, max.	5 000 m	5 000 m	5 000 m	5 000 m
• Ambient air temperature-barometric pressure-altitude	Tmin ... Tmax at 1 140 hPa ... 795 hPa (-1 000 m ... +2 000 m) // Tmin ... (Tmax - 10 K) at 795 hPa ... 658 hPa (+2 000 m ... +3 500 m) // Tmin ... (Tmax -20 K) at 658 hPa ... 540 hPa (+3 500 m ... +5 000 m)	Tmin ... Tmax at 1 140 hPa ... 795 hPa (-1 000 m ... +2 000 m) // Tmin ... (Tmax - 10 K) at 795 hPa ... 658 hPa (+2 000 m ... +3 500 m) // Tmin ... (Tmax -20 K) at 658 hPa ... 540 hPa (+3 500 m ... +5 000 m)	Tmin ... Tmax at 1 140 hPa ... 795 hPa (-1 000 m ... +2 000 m) // Tmin ... (Tmax - 10 K) at 795 hPa ... 658 hPa (+2 000 m ... +3 500 m) // Tmin ... (Tmax -20 K) at 658 hPa ... 540 hPa (+3 500 m ... +5 000 m)	Tmin ... Tmax at 1 140 hPa ... 795 hPa (-1 000 m ... +2 000 m) // Tmin ... (Tmax - 10 K) at 795 hPa ... 658 hPa (+2 000 m ... +3 500 m) // Tmin ... (Tmax -20 K) at 658 hPa ... 540 hPa (+3 500 m ... +5 000 m)
Relative humidity				
• With condensation, tested in accordance with IEC 60068-2-38, max.	100 %; RH incl. condensation/frost (no commissioning under condensation conditions)	100 %; RH incl. condensation/frost (no commissioning under condensation conditions)	100 %; RH incl. condensation / frost (no commissioning in bedewed state), horizontal installation	100 %; RH incl. condensation / frost (no commissioning in bedewed state), horizontal installation
Resistance				
Coolants and lubricants				
- Resistant to commercially available coolants and lubricants	Yes; Incl. diesel and oil droplets in the air	Yes; Incl. diesel and oil droplets in the air	Yes; Incl. diesel and oil droplets in the air	Yes; Incl. diesel and oil droplets in the air
Use in stationary industrial systems				
- to biologically active substances according to EN 60721-3-3	Yes; Class 3B2 mold, fungus and dry rot spores (with the exception of fauna); Class 3B3 on request	Yes; Class 3B2 mold, fungus and dry rot spores (with the exception of fauna); Class 3B3 on request	Yes; Class 3B2 mold, fungus and dry rot spores (with the exception of fauna); Class 3B3 on request	Yes; Class 3B2 mold, fungus and dry rot spores (with the exception of fauna); Class 3B3 on request
- to chemically active substances according to EN 60721-3-3	Yes; Class 3C4 (RH < 75 %) incl. salt spray acc. to EN 60068-2-52 (severity degree 3); *	Yes; Class 3C4 (RH < 75 %) incl. salt spray acc. to EN 60068-2-52 (severity degree 3); *	Yes; Class 3C4 (RH < 75 %) incl. salt spray acc. to EN 60068-2-52 (severity degree 3); *	Yes; Class 3C4 (RH < 75 %) incl. salt spray acc. to EN 60068-2-52 (severity degree 3); *
- to mechanically active substances according to EN 60721-3-3	Yes; Class 3S4 incl. sand, dust, *	Yes; Class 3S4 incl. sand, dust, *	Yes; Class 3S4 incl. sand, dust, *	Yes; Class 3S4 incl. sand, dust, *

Technical specifications

Article number	6AG1531-7NF10-7AB0	6AG1531-7KF00-7AB0	6AG1531-7NF00-7AB0	6AG1531-7PF00-4AB0
Based on	6ES7531-7NF10-0AB0 SIPLUS S7-1500 AI 8XU/I HS	6ES7531-7KF00-0AB0 SIPLUS S7-1500 AI 8XU/I/RTD/TC ST	6ES7531-7NF00-0AB0 SIPLUS S7-1500 AI 8XU/I HF	6ES7531-7PF00-0AB0 SIPLUS S7-1500 AI 8XU/R/RTD/TC HF
Use on ships/at sea				
- to biologically active substances according to EN 60721-3-6	Yes; Class 6B2 mold and fungal spores (excluding fauna); Class 6B3 on request	Yes; Class 6B2 mold and fungal spores (excluding fauna); Class 6B3 on request	Yes; Class 6B2 mold and fungal spores (excluding fauna); Class 6B3 on request	Yes; Class 6B2 mold and fungal spores (excluding fauna); Class 6B3 on request
- to chemically active substances according to EN 60721-3-6	Yes; Class 6C3 (RH < 75 %) incl. salt spray acc. to EN 60068-2-52 (severity degree 3); *	Yes; Class 6C3 (RH < 75 %) incl. salt spray acc. to EN 60068-2-52 (severity degree 3); *	Yes; Class 6C3 (RH < 75 %) incl. salt spray acc. to EN 60068-2-52 (severity degree 3); *	Yes; Class 6C3 (RH < 75 %) incl. salt spray acc. to EN 60068-2-52 (severity degree 3); *
- to mechanically active substances according to EN 60721-3-6	Yes; Class 6S3 incl. sand, dust; *	Yes; Class 6S3 incl. sand, dust; *	Yes; Class 6S3 incl. sand, dust; *	Yes; Class 6S3 incl. sand, dust; *
Usage in industrial process technology				
- Against chemically active substances acc. to EN 60654-4	Yes; Class 3 (excluding trichlorethylene)	Yes; Class 3 (excluding trichlorethylene)	Yes; Class 3 (excluding trichlorethylene)	Yes; Class 3 (excluding trichlorethylene)
- Environmental conditions for process, measuring and control systems acc. to ANSI/ISA-71.04	Yes; Level GX group A/B (excluding trichlorethylene; harmful gas concentrations up to the limits of EN 60721-3-3 class 3C4 permissible); level LC3 (salt spray) and level LB3 (oil)	Yes; Level GX group A/B (excluding trichlorethylene; harmful gas concentrations up to the limits of EN 60721-3-3 class 3C4 permissible); level LC3 (salt spray) and level LB3 (oil)	Yes; Level GX group A/B (excluding trichlorethylene; harmful gas concentrations up to the limits of EN 60721-3-3 class 3C4 permissible); level LC3 (salt spray) and level LB3 (oil)	Yes; Level GX group A/B (excluding trichlorethylene; harmful gas concentrations up to the limits of EN 60721-3-3 class 3C4 permissible); level LC3 (salt spray) and level LB3 (oil)
Remark				
- Note regarding classification of environmental conditions acc. to EN 60721, EN 60654-4 and ANSI/ISA-71.04	* The supplied plug covers must remain in place over the unused interfaces during operation!	* The supplied plug covers must remain in place over the unused interfaces during operation!	* The supplied plug covers must remain in place over the unused interfaces during operation!	* The supplied plug covers must remain in place over the unused interfaces during operation!
Conformal coating				
• Coatings for printed circuit board assemblies acc. to EN 61086	Yes; Class 2 for high availability	Yes; Class 2 for high availability	Yes; Class 2 for high availability	Yes; Class 2 for high availability
• Protection against fouling acc. to EN 60664-3	Yes; Type 1 protection	Yes; Type 1 protection	Yes; Type 1 protection	Yes; Type 1 protection
• Military testing according to MIL-I-46058C, Amendment 7	Yes; Discoloration of coating possible during service life	Yes; Discoloration of coating possible during service life	Yes; Discoloration of coating possible during service life	Yes; Discoloration of coating possible during service life
• Qualification and Performance of Electrical Insulating Compound for Printed Board Assemblies according to IPC-CC-830A	Yes; Conformal coating, Class A	Yes; Conformal coating, Class A	Yes; Conformal coating, Class A	Yes; Conformal coating, Class A

Ordering data

SIPLUS SM 531 analog input modules

(Extended temperature range and exposure to environmental substances)

8 analog inputs, ± 10 V, ± 5 V, 1 ... 5 V or 0/4 ... 20 mA, ± 20 mA, 16-bit + sign; incl. infeed element, shielding bracket, shield terminal, labeling strips, U connector, printed front door

8 analog inputs
 ± 10 V, ± 5 V, ± 2.5 V, ± 1 V, ± 500 mV, ± 250 mV, ± 80 mV, ± 50 mV, 1 ... 5 V, 0/4 ... 20 mA, ± 20 mA, thermocouples type B, E, J, K, N, R, S, T, resistance thermometers Ni 100, Ni 1000, LG-Ni 1000, Pt 100, Pt 1000, Pt 250, Pt 500, resistors 0...150/300/600/6000 ohms, 16-bit

Article No.

6AG1531-7NF10-7AB0

6AG1531-7KF00-7AB0

Article No.

6AG1531-7NF00-7AB0

6AG1531-7PF00-4AB0

8 analog inputs, ± 10 V, ± 5 V, 1 ... 5 V or 0/4 ... 20 mA, ± 20 mA, 16-bit + sign; including infeed element, shielding bracket, shield terminal, labeling strips, U connector, printed front door

8 analog inputs, ± 1 V, ± 500 mV, ± 250 mV, ± 80 mV, ± 50 mV, ± 25 mV; thermocouples type B, E, J, K, N, R, S, T, TXK/TXK(L) according to GOST; resistance thermometers Cu 10, Cu 50, Cu 100, Ni 10, Ni 100, Ni 120, Ni 200, Ni 500, Ni 1000, LG-Ni 1000, Pt10, Pt50, Pt100, Pt200, Pt500, Pt1000; resistors 0...150/300/600/6 000 ohms, PTC; 16-bit; incl. infeed element, shield bracket, shield terminal, labeling strips, U connector, printed front door

Accessories

See SIMATIC S7-1500 SM 531 analog input modules, catalog ST 70 · 2019, page 4/112

SIMATIC S7-1500 Advanced Controllers

I/O modules

Communication

CM 8xIO-Link

Overview



- Communication module for connecting up to 8 IO-Link devices (three-wire connection) or 8 standard sensors
- Can be used directly downstream of an S7-1500 CPU or distributed in ET 200MP via PROFINET or PROFIBUS
- Powerful diagnostics functions facilitate preventive maintenance to avoid plant standstills
- Easy replacement of sensors/actuators without time-consuming parameter assignment

4

Technical specifications

Article number	6ES7547-1JF00-0AB0 S7-1500, CM 8xIO-Link
General information	
Product type designation	CM 8xIO-Link
Product function	
• I&M data	Yes; I&M0 to I&M3
Engineering with	
• STEP 7 TIA Portal configurable/integrated as of version	V15.1 with HSP 274
• STEP 7 configurable/integrated as of version	Configurable via GSD file
• PROFIBUS as of GSD version/GSD revision	GSD as of Revision 5
• PROFINET as of GSD version/GSD revision	GSDML V2.34
Supply voltage	
Rated value (DC)	24 V
Reverse polarity protection	Yes
Encoder supply	
Number of outputs	8
Output current	
• Rated value	1 A; 4 A total current per module
24 V encoder supply	
• Short-circuit protection	Yes; per channel, electronic
IO-Link	
Number of ports	8
• of which simultaneously controllable	8
IO-Link protocol 1.0	Yes
IO-Link protocol 1.1	Yes
Cycle time, min.	2 ms
Size of process data, input per port	33 byte; max.
Size of process data, input per module	240 byte; max.
Size of process data, output per port	32 byte; max.
Size of process data, output per module	240 byte; max.
Memory size for device parameter	2 kbyte; for each port

Article number	6ES7547-1JF00-0AB0 S7-1500, CM 8xIO-Link
Master backup	Yes
Configuration without S7-PCT	Yes
Cable length unshielded, max.	20 m
Operating modes	
• IO-Link	Yes
• DI	Yes
• DQ	No
Time Based IO	
- TIO IO-Link IN	No
- TIO IO-Link OUT	No
- TIO IO-Link IN/OUT	No
Connection of IO-Link devices	
• Port type A	Yes
• Port type B	Yes; 24 V DC via external terminal
Interrupts/diagnostics/status information	
Alarms	
• Diagnostic alarm	Yes; The port diagnosis is available in the IO-Link mode only.
Diagnostic messages	
• Monitoring the supply voltage	Yes
• Wire-break	Yes
• Short-circuit	Yes
• Group error	Yes
Diagnostics indication LED	
• Monitoring of the supply voltage (PWR-LED)	Yes; green LED
• Channel status display	Yes; green LED
• for channel diagnostics	Yes; red LED
• for module diagnostics	Yes; red LED
Potential separation	
Potential separation channels	
• between the channels and backplane bus	Yes

Technical specifications

Article number	6ES7547-1JF00-0AB0 S7-1500, CM 8xIO-Link
Ambient conditions	
Ambient temperature during operation	
• horizontal installation, min.	0 °C
• horizontal installation, max.	60 °C; Observe derating
• vertical installation, min.	0 °C
• vertical installation, max.	40 °C; Observe derating
Dimensions	
Width	35 mm
Height	147 mm
Depth	129 mm

Ordering data**Article No.**

CM 8xIO-Link communication module	6ES7547-1JF00-0AB0
Communication module for connecting up to 8 IO-Link devices (three-wire connection) or 8 standard sensors	
SIMATIC Manual Collection	6ES7998-8XC01-8YE0
Electronic manuals on DVD, multilingual: LOGO!, SIMADYN, SIMATIC bus components, SIMATIC C7, SIMATIC distributed I/O, SIMATIC HMI, SIMATIC sensors, SIMATIC NET, SIMATIC PC-based Automation, SIMATIC PCS 7, SIMATIC PG/PC, SIMATIC S7, SIMATIC software, SIMATIC TDC	
SIMATIC Manual Collection update service for 1 year	6ES7998-8XC01-8YE2
Current "Manual Collection" DVD and the three subsequent updates	

SIMATIC S7-1500 Advanced Controllers

I/O modules

Communication

CP 1545-1

Overview



- Security Integrated
 - Stateful Packet Inspection Firewall
- Protocols for secure communication
 - Secure access to the web server of the CPU via the HTTPS protocol
 - Secure file transfer using FTPS
 - Secure time of day transfer (NTP)
 - SNMPv3 for tap-proof transfer of network analysis information
 - Encrypted email communication via SMTPS (Port 587)
 - Secure open communication over TCP/IP
- Integration of the S7-1500 into IPv6-based networks

An IPv6-compliant IP address can be used for the following communications services:

 - MQTT
 - FETCH/WRITE access (CP as server)
 - FTP server mode
 - FTP client mode with addressing via program block
 - Email transfer with addressing via program block

ISO	TCP/ UDP	PN	MRP	IT	IP-R	PG/OP	S7/S5
●	●			●	●	●	●

The SIMATIC CP 1545-1 communications processor securely connects the SIMATIC S7-1500 controller to Industrial Ethernet networks. The new CloudConnect functionality enables easy and reliable transfer of all selected data from the SIMATIC S7-1500 to MindSphere, or a cloud solution that supports the standardized MQTT protocol, e.g. Microsoft Azure or IBM Cloud. The CP protects the SIMATIC S7-1500 station from unauthorized access with the integrated SPI (Stateful Packet Inspection) firewall. Data from cloud systems or MQTT brokers can also be received using the MQTT protocol.

The CloudConnect function of the CP 1545-1 is easy to configure with a few input screens in TIA Portal. First, all the parameters required for the different cloud platforms are specified. The data intended for the cloud is then selected from the tag management of the SIMATIC S7-1500 and saved as topics to be transferred with the corresponding trigger conditions.

All functions are configured using STEP 7 Professional V15.1 update 3 (TIA Portal) or higher.

The CP 1545-1 supports the following communications services:

- PG/OP communication
- S7 communication
- Open user communication (SEND/RECEIVE, FETCH/WRITE)
- IT communication
 - MQTT Publish for transferring selected data to a cloud system or MQTT broker
 - MQTT Subscribe for receiving data from a cloud system or MQTT broker
 - FTP functions (File Transfer Protocol FTP/FTPS) for file management and access to data blocks in the CPU (client and server function)
 - Access (read and write modes) to csv files stored on the memory card of the CPU via FTP(S)
 - Sending emails via SMTP or ESMTP with "SMTP-Auth" for authentication to an email server (also with IPv6)
 - Static IP routing with up to 1 Mbps via IPv4 to other CP 1545-1 / CP 1543-1 / CM 1542-1 units in the S7-1500 system, e.g. for web server accesses without real-time capability

Technical specifications

Article number	6GK7545-1GX00-0XE0 CP 1545-1
Transfer rate	
Transfer rate	
• at the 1st interface	10 ... 1 000 Mbit/s
Interfaces	
Number of interfaces acc. to Industrial Ethernet	1
Number of electrical connections	
• at the 1st interface acc. to Industrial Ethernet	1
Type of electrical connection	
• at the 1st interface acc. to Industrial Ethernet	RJ45 port
Supply voltage, current consumption, power loss	
Type of voltage of the supply voltage	DC
Supply voltage 1 from backplane bus	15 V
Relative symmetrical tolerance at DC	
• at 15 V	3 %
Consumed current	
• from backplane bus at DC at 15 V typical	0.3 A
Power loss [W]	4.5 W
Ambient conditions	
Ambient temperature	
• for vertical installation during operation	0 ... 40 °C
• for horizontally arranged busbars during operation	0 ... 60 °C
• during storage	-40 ... +70 °C
• during transport	-40 ... +70 °C
Relative humidity	
• at 25 °C without condensation during operation maximum	95 %
Protection class IP	IP20
Design, dimensions and weights	
Module format	Compact module S7-1500 single width
Width	35 mm
Height	142 mm
Depth	129 mm
Net weight	0.32 kg
Mounting type	
• S7-1500 rail mounting	Yes
Product features, product functions, product components general	
Number of units	
• per CPU maximum	8
• Note	depending on CPU type

Article number	6GK7545-1GX00-0XE0 CP 1545-1
Product functions	
Cloud Connectivity	
Protocol is supported	
• Message Queuing Telemetry Transport (MQTT)	Yes
• Advanced Message Queuing Protocol (AMQP)	No
Product function for cloud connectivity	
• trigger management	Yes
• time stamping	Yes
Product feature for cloud connectivity Buffered message frame memory	No
Number of data points per device maximum	500
Performance data open communication	
Number of possible connections for open communication	
• by means of T blocks maximum	118; depending on the system upper limit
Amount of data	
• as user data per ISO on TCP connection for open communication by means of T blocks maximum	65 536 byte
Number of Multicast stations	118
Performance data S7 communication	
Number of possible connections for S7 communication	
• maximum	118; depending on the system upper limit
Performance data multi-protocol mode	
Number of active connections with multi-protocol mode	118
Performance data IT functions	
Number of possible connections	
• as client by means of FTP maximum	32
• as server by means of FTP maximum	16
Number of possible connections	
• as server by means of HTTP maximum	4
• as e-mail client maximum	1
Amount of data as user data for email maximum	64 Kibyte
Performance data telecontrol	
Protocol is supported	
• TCP/IP	Yes
Product functions management, configuration, engineering	
Product function MIB support	Yes
Protocol is supported	
• SNMP v1	Yes
• SNMP v3	Yes
• DCP	Yes
• LLDP	Yes
Identification & maintenance function	
• I&M0 - device-specific information	Yes
• I&M1 - higher-level designation/ location designation	Yes

SIMATIC S7-1500 Advanced Controllers

I/O modules

Communication

CP 1545-1

Technical specifications

Article number	6GK7545-1GX00-0XE0 CP 1545-1
Product functions Diagnostics	
Product function Web-based diagnostics	Yes; via S7-1500 CPU
Product functions Routing	
Service Routing Note	IP routing up to 1 Mbps
Product function	
• Static IP routing	Yes
• Static IP routing IPv6	No
• dynamic IP routing	No
• dynamic IP routing IPv6	No
Protocol is supported	
• RIP v1	No
• RIPv2	No
• RIPnG for IPv6	No
• OSPFv2	No
• OSPFv3 for IPv6	No
• VRRP	No
• VRRP for IPv6	No
• BGP	No
• PPP	No
• PPoE via DSL	No
Product functions Security	
Firewall version	stateful inspection
Product function	
• password protection for Web applications	No
• ACL - IP-based	No
• ACL - IP-based for PLC/routing	No
• switch-off of non-required services	Yes
• Blocking of communication via physical ports	No
• log file for unauthorized access	Yes
Product functions time	
Product function SICLOCK support	No
Product function pass on time synchronization	Yes
Protocol is supported	
• NTP	Yes

Ordering data

CP 1545-1 communications processor

CP 1545-1 communications processor for connecting the SIMATIC S7-1500 to Industrial Ethernet; TCP/IP, UDP, S7 communication, security (firewall), SNMPv1/v3, DHCP, FTP client/server, email, IPv4/IPv6, time synchronization via NTP, connection to cloud systems via MQTT, 1x RJ45 (10/100/1 000 Mbps)

Note:

You can find order information for software for communication with PC systems under System connections – Software overview

Article No.

6GK7545-1GX00-0XE0

Overview



SIPLUS digital fail-safe input module: F-DI 16x24 V DC

Important properties:

- 16-channel fail-safe digital input module for ET 200MP/ S7-1500
- For fail-safe reading of sensor information (1 or 2 channels)
- Provides integral discrepancy evaluation for 2-out-of-2 signals

- 4 internal sensor supplies (incl. test function) onboard
- Certified up to SIL 3 (IEC 61508), PL e (ISO 13849)
- LED display for error, operation, supply voltage and status
- Clear module labeling
 - Plain text identification of the module type
 - Complete Article No.
 - 2D matrix code (article and serial number)
 - Connection diagram
 - Hardware and firmware version
- Optional labeling accessories
 - Labeling sheets, yellow
- The modules support PROFIsafe in both PROFIBUS and PROFINET configurations. Can be used with all fail-safe SIMATIC S7-1500 F-CPU's in the central configuration, as well as ET 200MP distributed I/O with all other SIMATIC S7 F-CPU's.

Note:

SIPLUS extreme products are based on SIMATIC standard products. The contents listed here were taken from the respective standard products. SIPLUS extreme-specific information was added.

Technical specifications

Article number	6AG1526-1BH00-2AB0
Based on	6ES7526-1BH00-0AB0 SIPLUS S7-1500 F-DI 16x24VDC
Ambient conditions	
Ambient temperature during operation	
• horizontal installation, min.	-25 °C; = Tmin
• horizontal installation, max.	60 °C; = Tmax
Altitude during operation relating to sea level	
• Installation altitude above sea level, max.	2 000 m
• Ambient air temperature-barometric pressure-altitude	Tmin ... Tmax at 1 140 hPa ... 795 hPa (-1 000 m ... +2 000 m)
Relative humidity	
• With condensation, tested in accordance with IEC 60068-2-38, max.	100 %; RH incl. condensation/frost (no commissioning under condensation conditions)
Resistance	
Coolants and lubricants	
- Resistant to commercially available coolants and lubricants	Yes; Incl. diesel and oil droplets in the air
Use in stationary industrial systems	
- to biologically active substances according to EN 60721-3-3	Yes; Class 3B2 mold, fungus and dry rot spores (with the exception of fauna); Class 3B3 on request
- to chemically active substances according to EN 60721-3-3	Yes; Class 3C4 (RH < 75 %) incl. salt spray acc. to EN 60068-2-52 (severity degree 3); *
- to mechanically active substances according to EN 60721-3-3	Yes; Class 3S4 incl. sand, dust, *

Article number	6AG1526-1BH00-2AB0
Based on	6ES7526-1BH00-0AB0 SIPLUS S7-1500 F-DI 16x24VDC
Use on ships/at sea	
- to biologically active substances according to EN 60721-3-6	Yes; Class 6B2 mold and fungal spores (excluding fauna); Class 6B3 on request
- to chemically active substances according to EN 60721-3-6	Yes; Class 6C3 (RH < 75 %) incl. salt spray acc. to EN 60068-2-52 (severity degree 3); *
- to mechanically active substances according to EN 60721-3-6	Yes; Class 6S3 incl. sand, dust; *
Usage in industrial process technology	
- Against chemically active substances acc. to EN 60654-4	Yes; Class 3 (excluding trichlorethylene)
- Environmental conditions for process, measuring and control systems acc. to ANSI/ISA-71.04	Yes; Level GX group A/B (excluding trichlorethylene; harmful gas concentrations up to the limits of EN 60721-3-3 class 3C4 permissible); level LC3 (salt spray) and level LB3 (oil)
Remark	
- Note regarding classification of environmental conditions acc. to EN 60721, EN 60654-4 and ANSI/ISA-71.04	* The supplied plug covers must remain in place over the unused interfaces during operation!
Conformal coating	
• Coatings for printed circuit board assemblies acc. to EN 61086	Yes; Class 2 for high reliability
• Protection against fouling acc. to EN 60664-3	Yes; Type 1 protection
• Military testing according to MIL-I-46058C, Amendment 7	Yes; Discoloration of coating possible during service life
• Qualification and Performance of Electrical Insulating Compound for Printed Board Assemblies according to IPC-CC-830A	Yes; Conformal coating, Class A

SIMATIC S7-1500 Advanced Controllers

I/O modules

SIPLUS F-digital/analog modules

SIPLUS digital F-input modules

Ordering data	Article No.
SIPLUS F-digital input module 16 inputs, 24 V DC, PROFISAFE	6AG1526-1BH00-2AB0
Accessories	
Coding elements E-coding element type F for SIPLUS ET 200MP modules F-DI/F-DQ; 5 units, spare part	6AG1592-6EF00-2AA0
Other accessories	See SIMATIC S7-1500 F-digital input modules, catalog ST 70 · 2019, page 4/177

Overview



SIPLUS digital fail-safe output module:
F-DQ 8x24 V DC 2 A PPM

Important properties:

- 8-channel digital fail-safe output module for ET 200MP/ S7-1500
- Fail-safe 2-channel activation (parameterizable PM/PP switching) of actuators

- Actuators can be controlled up to 2 A
- Certified up to SIL 3 (IEC 61508), PL e (ISO 13849)
- LED display for error, operation, supply voltage and status
- Clear module labeling
 - Plain text identification of the module type
 - Complete Article No.
 - 2D matrix code (article and serial number)
 - Connection diagram
 - Hardware and firmware version
- Optional labeling accessories
 - Labeling sheets, yellow
- The module supports PROFIsafe in both PROFIBUS and PROFINET configurations.
- Can be used with all fail-safe SIMATIC S7-1500 F-CPU's in the central configuration, as well as ET 200MP distributed I/O with all other SIMATIC S7 F-CPU's.

Note:

SIPLUS extreme products are based on SIMATIC standard products. The contents listed here were taken from the respective standard products. SIPLUS extreme-specific information was added.

Technical specifications

Article number	6AG1526-2BF00-2AB0
Based on	6ES7526-2BF00-0AB0 SIPLUS S7-1500 F-DQ 8x24VDC/2A
Ambient conditions	
Ambient temperature during operation	
• horizontal installation, min.	-25 °C; = Tmin
• horizontal installation, max.	60 °C; = Tmax
Altitude during operation relating to sea level	
• Installation altitude above sea level, max.	2 000 m
• Ambient air temperature-barometric pressure-altitude	Tmin ... Tmax at 1 140 hPa ... 795 hPa (-1 000 m ... +2 000 m)
Relative humidity	
• With condensation, tested in accordance with IEC 60068-2-38, max.	100 %; RH incl. condensation/frost (no commissioning under condensation conditions)
Resistance	
Coolants and lubricants	
- Resistant to commercially available coolants and lubricants	Yes; Incl. diesel and oil droplets in the air
Use in stationary industrial systems	
- to biologically active substances according to EN 60721-3-3	Yes; Class 3B2 mold, fungus and dry rot spores (with the exception of fauna); Class 3B3 on request
- to chemically active substances according to EN 60721-3-3	Yes; Class 3C4 (RH < 75 %) incl. salt spray acc. to EN 60068-2-52 (severity degree 3); *
- to mechanically active substances according to EN 60721-3-3	Yes; Class 3S4 incl. sand, dust, *

Article number	6AG1526-2BF00-2AB0
Based on	6ES7526-2BF00-0AB0 SIPLUS S7-1500 F-DQ 8x24VDC/2A
Use on ships/at sea	
- to biologically active substances according to EN 60721-3-6	Yes; Class 6B2 mold and fungal spores (excluding fauna); Class 6B3 on request
- to chemically active substances according to EN 60721-3-6	Yes; Class 6C3 (RH < 75 %) incl. salt spray acc. to EN 60068-2-52 (severity degree 3); *
- to mechanically active substances according to EN 60721-3-6	Yes; Class 6S3 incl. sand, dust; *
Usage in industrial process technology	
- Against chemically active substances acc. to EN 60654-4	Yes; Class 3 (excluding trichlorethylene)
- Environmental conditions for process, measuring and control systems acc. to ANSI/ISA-71.04	Yes; Level GX group A/B (excluding trichlorethylene; harmful gas concentrations up to the limits of EN 60721-3-3 class 3C4 permissible); level LC3 (salt spray) and level LB3 (oil)
Remark	
- Note regarding classification of environmental conditions acc. to EN 60721, EN 60654-4 and ANSI/ISA-71.04	* The supplied plug covers must remain in place over the unused interfaces during operation!

SIMATIC S7-1500 Advanced Controllers

I/O modules

SIPLUS F-digital/analog modules

SIPLUS digital F-output modules**Technical specifications**

Article number	6AG1526-2BF00-2AB0
Based on	6ES7526-2BF00-0AB0 SIPLUS S7-1500 F-DQ 8x24VDC/2A

Conformal coating

<ul style="list-style-type: none"> • Coatings for printed circuit board assemblies acc. to EN 61086 	Yes; Class 2 for high reliability
<ul style="list-style-type: none"> • Protection against fouling acc. to EN 60664-3 	Yes; Type 1 protection
<ul style="list-style-type: none"> • Military testing according to MIL-I-46058C, Amendment 7 	Yes; Discoloration of coating possible during service life
<ul style="list-style-type: none"> • Qualification and Performance of Electrical Insulating Compound for Printed Board Assemblies according to IPC-CC-830A 	Yes; Conformal coating, Class A

Ordering data**SIPLUS F-digital output module**

8 outputs, 24 V DC, 2 A, PROFISAFE, p/m-switching

Accessories**Coding elements**

E-coding element type F for SIPLUS ET 200 MP-module F-DI/F-DQ; 5 units, spare part

Other accessories**Article No.****6AG1526-2BF00-2AB0****6AG1592-6EF00-2AA0**

See SIMATIC S7-1500 F-digital output modules, catalog ST 70 · 2019, page 4/180

Distributed Controllers



7/2	based on ET 200SP
7/2	<u>SIPLUS standard CPUs</u>
7/2	SIPLUS CPU 1510SP-1 PN
7/5	SIPLUS CPU 1512SP-1 PN
7/8	<u>ET 200SP Open Controllers</u>
7/8	Technology CPUs
7/8	- CPU 1515SP PC2 T
7/12	- CPU 1515SP PC2 TF
7/16	<u>SIPLUS ET 200SP Open Controllers</u>
7/16	SIPLUS standard CPUs
7/16	- SIPLUS CPU 1515SP PC2
7/18	SIPLUS fail-safe CPUs
7/18	- SIPLUS CPU 1515SP PC2 F
7/20	based on ET 200Pro
7/20	<u>Standard CPUs</u>
7/20	CPU 1513pro-2 PN
7/25	<u>Fail-safe CPUs</u>
7/25	CPU 1513pro F-2 PN

Distributed Controllers

based on ET 200SP
SIPLUS standard CPUs

SIPLUS CPU 1510SP-1 PN

Overview



- PROFINET shared I-Device for 4 controllers
- PROFINET IO IRT interface with integrated 3-port switch
- Isochronous mode on PROFINET
- With multiple communication options: PG/OP communication, PROFINET IO, open IE communication (TCP, ISO-on-TCP and UDP), web server and S7 communication (with loadable FBs)
- Optional PROFIBUS DP master for 125 PROFIBUS DP slaves (with CM DP module 6ES7545-5DA00-0AB0)
- Optional PROFIBUS DP slave (with CM DP module 6ES7545-5DA00-0AB0)
- Configuration control (option handling)
- Integrated Motion Control functionalities for controlling speed-controlled and positioning axes, support for external encoders

Note

SIMATIC Memory Card required for operation of the CPU. The BusAdapter is not included in the scope of delivery and is to be ordered separately. No BusAdapter can be inserted with the variant for the temperature range -40...+70 °C.

SIPLUS extreme products are based on SIMATIC standard products. The contents listed here were taken from the respective standard products. SIPLUS extreme-specific information was added.

- SIPLUS CPU 1510SP-1 PN for SIPLUS ET 200SP based on SIPLUS-S7-1500 CPU 1511-1 PN
- For high-performance control solutions using ET 200SP
- Increase in availability of systems and machines
- PROFINET IO controller for up to 64 IO devices
- PROFINET I-Device for connecting the CPU as an intelligent PROFINET device with a SIMATIC or non-Siemens PROFINET I/O controller

Technical specifications

Article number	6AG1510-1DJ01-2AB0	6AG1510-1DJ01-7AB0
Based on	6ES7510-1DJ01-0AB0 SIPLUS ET 200SP CPU 1510SP-1 PN	6ES7510-1DJ01-0AB0 SIPLUS ET 200SP CPU 1510SP-1 PN
Ambient conditions		
Ambient temperature during operation		
• horizontal installation, min.	-40 °C; = Tmin (incl. condensation/frost)	-40 °C; = Tmin
• horizontal installation, max.	60 °C; = Tmax	70 °C; = Tmax
• vertical installation, min.	-40 °C; = Tmin	-40 °C; = Tmin
• vertical installation, max.	50 °C; = Tmax	50 °C; = Tmax
Altitude during operation relating to sea level		
• Installation altitude above sea level, max.	5 000 m	5 000 m
• Ambient air temperature-barometric pressure-altitude	Tmin ... Tmax at 1 140 hPa ... 795 hPa (-1 000 m ... +2 000 m) // Tmin ... (Tmax - 10 K) at 795 hPa ... 658 hPa (+2 000 m ... +3 500 m) // Tmin ... (Tmax -20 K) at 658 hPa ... 540 hPa (+3 500 m ... +5 000 m)	Tmin ... Tmax at 1 140 hPa ... 795 hPa (-1 000 m ... +2 000 m) // Tmin ... (Tmax - 10 K) at 795 hPa ... 658 hPa (+2 000 m ... +3 500 m) // Tmin ... (Tmax -20 K) at 658 hPa ... 540 hPa (+3 500 m ... +5 000 m)
Relative humidity		
• With condensation, tested in accordance with IEC 60068-2-38, max.	100 %; RH incl. condensation / frost (no commissioning in bedewed state), horizontal installation	100 %; RH incl. condensation / frost (no commissioning in bedewed state), horizontal installation
Resistance		
Coolants and lubricants		
- Resistant to commercially available coolants and lubricants	Yes; Incl. diesel and oil droplets in the air	Yes; Incl. diesel and oil droplets in the air

Technical specifications

Article number	6AG1510-1DJ01-2AB0	6AG1510-1DJ01-7AB0
Based on	6ES7510-1DJ01-0AB0 SIPLUS ET 200SP CPU 1510SP-1 PN	6ES7510-1DJ01-0AB0 SIPLUS ET 200SP CPU 1510SP-1 PN
Use in stationary industrial systems		
- to biologically active substances according to EN 60721-3-3	Yes; Class 3B2 mold, fungus and dry rot spores (with the exception of fauna); Class 3B3 on request	Yes; Class 3B2 mold, fungus and dry rot spores (with the exception of fauna); Class 3B3 on request
- to chemically active substances according to EN 60721-3-3	Yes; Class 3C4 (RH < 75%) incl. salt spray according to EN 60068-2-52 (degree of severity 3). The supplied connector covers must remain on the unused interfaces during operation!	Yes; Class 3C4 (RH < 75 %) incl. salt spray acc. to EN 60068-2-52 (severity degree 3); *
- to mechanically active substances according to EN 60721-3-3	Yes; Class 3S4 incl. sand, dust. The supplied connector covers must remain on the unused interfaces during operation!	Yes; Class 3S4 incl. sand, dust, *
- Against mechanical environmental conditions acc. to EN 60721-3-3	Yes; Class 3M8 using the SIPLUS Mounting Kit ET 200SP (6AG1193-6AA00-0AA0)	
Use on ships/at sea		
- to biologically active substances according to EN 60721-3-6	Yes; Class 6B2 mold and fungal spores (excluding fauna); Class 6B3 on request	Yes; Class 6B2 mold, fungal and dry rot spores (excluding fauna)
- to chemically active substances according to EN 60721-3-6	Yes; Class 6C3 (RH < 75 %) incl. salt spray acc. to EN 60068-2-52 (severity degree 3); *	Yes; Class 6C3 (RH < 75 %) incl. salt spray acc. to EN 60068-2-52 (severity degree 3); *
- to mechanically active substances according to EN 60721-3-6	Yes; Class 6S3 incl. sand, dust; *	Yes; Class 6S3 incl. sand, dust; *
- Against mechanical environmental conditions acc. to EN 60721-3-6	Yes; Class 6M4 using the SIPLUS Mounting Kit ET 200SP (6AG1193-6AA00-0AA0)	
Usage in industrial process technology		
- Against chemically active substances acc. to EN 60654-4	Yes; Class 3 (excluding trichlorethylene)	Yes; Class 3 (excluding trichlorethylene)
- Environmental conditions for process, measuring and control systems acc. to ANSI/ISA-71.04	Yes; Level GX group A/B (excluding trichlorethylene; harmful gas concentrations up to the limits of EN 60721-3-3 class 3C4 permissible); level LC3 (salt spray) and level LB3 (oil)	Yes; Level GX group A/B (excluding trichlorethylene; harmful gas concentrations up to the limits of EN 60721-3-3 class 3C4 permissible); level LC3 (salt spray) and level LB3 (oil)
Remark		
- Note regarding classification of environmental conditions acc. to EN 60721, EN 60654-4 and ANSI/ISA-71.04	* The supplied plug covers must remain in place over the unused interfaces during operation!	* The supplied plug covers must remain in place over the unused interfaces during operation!
Conformal coating		
• Coatings for printed circuit board assemblies acc. to EN 61086	Yes; Class 2 for high availability	Yes; Class 2 for high availability
• Protection against fouling acc. to EN 60664-3	Yes; Type 1 protection	Yes; Type 1 protection
• Military testing according to MIL-I-46058C, Amendment 7	Yes; Discoloration of coating possible during service life	Yes; Discoloration of coating possible during service life
• Qualification and Performance of Electrical Insulating Compound for Printed Board Assemblies according to IPC-CC-830A	Yes; Conformal coating, Class A	Yes; Conformal coating, Class A

Distributed Controllers

based on ET 200SP

SIPLUS standard CPUs

SIPLUS CPU 1510SP-1 PN**Ordering data****Article No.****SIPLUS CPU 1510SP-1 PN**

(Extended temperature range and medial exposure)

Work memory 100 KB for program, 750 KB for data, PROFINET I/O IRT interface; SIMATIC Memory Card required

Temperature range -40 ... +60 °C

6AG1510-1DJ01-2AB0

Temperature range -40 ... +70 °C; No BusAdapter can be inserted

6AG1510-1DJ01-7AB0**Accessories****BA 2xRJ45 BusAdapter****6AG1193-6AR00-7AA0**

(Extended temperature range and medial exposure)

BA 2xFC BusAdapter for increased vibration and EMC loads**6AG1193-6AF00-7AA0**

(Extended temperature range and medial exposure)

IE FC RJ45 plugs

RJ45 plug connector for Industrial Ethernet with a rugged metal enclosure and integrated insulation displacement contacts for connecting Industrial Ethernet FC installation cables

IE FC RJ45 plug 180

(Extended temperature range and medial exposure)

180° cable outlet

1 unit

6AG1901-1BB10-7AA0**Other accessories**

See SIMATIC ET 200SP CPU 1510SP-1 PN, catalog ST 70 · 2019, page 7/4

Overview



- SIPLUS CPU 1512SP-1 PN for SIPLUS ET 200SP based on SIPLUS S7-1500 CPU 1513-1 PN
- For applications with medium requirements regarding the program scope and processing speed, for distributed setup via PROFINET IO or PROFIBUS DP.
- Increase in availability of systems and machines
- PROFINET IO controller for up to 128 IO devices

- PROFINET I-Device for connecting the CPU as an intelligent PROFINET device with a SIMATIC or non-Siemens PROFINET I/O controller
- PROFINET shared I-Device for 4 controllers
- PROFINET IO IRT interface with integrated 3-port switch
- Isochronous mode on PROFINET
- With multiple communication options: PG/OP communication, PROFINET IO, open IE communication (TCP, ISO-on-TCP and UDP), web server and S7 communication (with loadable FBs)
- Optional PROFIBUS DP master for 125 PROFIBUS DP slaves (with CM DP module 6ES7545-5DA00-0AB0)
- Optional PROFIBUS DP slave (with CM DP module 6ES7545-5DA00-0AB0)
- Configuration control (option handling)
- Integrated Motion Control functionalities for controlling speed-controlled and positioning axes, support for external encoders

Note

SIMATIC Memory Card required for operation of the CPU. BusAdapter is not included in scope of delivery and is to be ordered separately. No BusAdapter can be inserted with the variant for the temperature range -40...+70 °C.

SIPLUS extreme products are based on SIMATIC standard products. The contents listed here were taken from the respective standard products. SIPLUS extreme-specific information was added.

7

Technical specifications

Article number	6AG1512-1DK01-2AB0	6AG1512-1DK01-7AB0
Based on	6ES7512-1DK01-0AB0 SIPLUS ET 200SP CPU 1512SP-1 PN	6ES7512-1DK01-0AB0 SIPLUS ET 200SP CPU 1512SP-1 PN
Ambient conditions		
Ambient temperature during operation		
• horizontal installation, min.	-40 °C; = Tmin (incl. condensation/frost)	-40 °C; = Tmin
• horizontal installation, max.	60 °C; = Tmax	70 °C; = Tmax
• vertical installation, min.	-40 °C; = Tmin	-40 °C; = Tmin
• vertical installation, max.	50 °C; = Tmax	50 °C; = Tmax
Altitude during operation relating to sea level		
• Installation altitude above sea level, max.	5 000 m	5 000 m
• Ambient air temperature-barometric pressure-altitude	Tmin ... Tmax at 1 140 hPa ... 795 hPa (-1 000 m ... +2 000 m) // Tmin ... (Tmax - 10 K) at 795 hPa ... 658 hPa (+2 000 m ... +3 500 m) // Tmin ... (Tmax -20 K) at 658 hPa ... 540 hPa (+3 500 m ... +5 000 m)	Tmin ... Tmax at 1 140 hPa ... 795 hPa (-1 000 m ... +2 000 m) // Tmin ... (Tmax - 10 K) at 795 hPa ... 658 hPa (+2 000 m ... +3 500 m) // Tmin ... (Tmax -20 K) at 658 hPa ... 540 hPa (+3 500 m ... +5 000 m)
Relative humidity		
• With condensation, tested in accordance with IEC 60068-2-38, max.	100 %; RH incl. condensation / frost (no commissioning in bedewed state), horizontal installation	100 %; RH incl. condensation / frost (no commissioning in bedewed state), horizontal installation
Resistance		
Coolants and lubricants		
- Resistant to commercially available coolants and lubricants	Yes; Incl. diesel and oil droplets in the air	Yes; Incl. diesel and oil droplets in the air

Distributed Controllers

based on ET 200SP
SIPLUS standard CPUs

SIPLUS CPU 1512SP-1 PN**Technical specifications**

Article number	6AG1512-1DK01-2AB0	6AG1512-1DK01-7AB0
Based on	6ES7512-1DK01-0AB0 SIPLUS ET 200SP CPU 1512SP-1 PN	6ES7512-1DK01-0AB0 SIPLUS ET 200SP CPU 1512SP-1 PN
Use in stationary industrial systems		
- to biologically active substances according to EN 60721-3-3	Yes; Class 3B2 mold, fungus and dry rot spores (with the exception of fauna); Class 3B3 on request	Yes; Class 3B2 mold, fungus and dry rot spores (with the exception of fauna); Class 3B3 on request
- to chemically active substances according to EN 60721-3-3	Yes; Class 3C4 (RH < 75%) incl. salt spray according to EN 60068-2-52 (degree of severity 3). The supplied connector covers must remain on the unused interfaces during operation!	Yes; Class 3C4 (RH < 75 %) incl. salt spray acc. to EN 60068-2-52 (severity degree 3); *
- to mechanically active substances according to EN 60721-3-3	Yes; Class 3S4 incl. sand, dust. The supplied connector covers must remain on the unused interfaces during operation!	Yes; Class 3S4 incl. sand, dust, *
- Against mechanical environmental conditions acc. to EN 60721-3-3	Yes; Class 3M8 using the SIPLUS Mounting Kit ET 200SP (6AG1193-6AA00-0AA0)	
Use on ships/at sea		
- to biologically active substances according to EN 60721-3-6	Yes; Class 6B2 mold and fungal spores (excluding fauna); Class 6B3 on request	Yes; Class 6B2 mold, fungal and dry rot spores (excluding fauna)
- to chemically active substances according to EN 60721-3-6	Yes; Class 6C3 (RH < 75 %) incl. salt spray acc. to EN 60068-2-52 (severity degree 3); *	Yes; Class 6C3 (RH < 75 %) incl. salt spray acc. to EN 60068-2-52 (severity degree 3); *
- to mechanically active substances according to EN 60721-3-6	Yes; Class 6S3 incl. sand, dust; *	Yes; Class 6S3 incl. sand, dust; *
- Against mechanical environmental conditions acc. to EN 60721-3-6	Yes; Class 6M4 using the SIPLUS Mounting Kit ET 200SP (6AG1193-6AA00-0AA0)	
Usage in industrial process technology		
- Against chemically active substances acc. to EN 60654-4	Yes; Class 3 (excluding trichlorethylene)	Yes; Class 3 (excluding trichlorethylene)
- Environmental conditions for process, measuring and control systems acc. to ANSI/ISA-71.04	Yes; Level GX group A/B (excluding trichlorethylene; harmful gas concentrations up to the limits of EN 60721-3-3 class 3C4 permissible); level LC3 (salt spray) and level LB3 (oil)	Yes; Level GX group A/B (excluding trichlorethylene; harmful gas concentrations up to the limits of EN 60721-3-3 class 3C4 permissible); level LC3 (salt spray) and level LB3 (oil)
Remark		
- Note regarding classification of environmental conditions acc. to EN 60721, EN 60654-4 and ANSI/ISA-71.04	* The supplied plug covers must remain in place over the unused interfaces during operation!	* The supplied plug covers must remain in place over the unused interfaces during operation!
Conformal coating		
• Coatings for printed circuit board assemblies acc. to EN 61086	Yes; Class 2 for high availability	Yes; Class 2 for high availability
• Protection against fouling acc. to EN 60664-3	Yes; Type 1 protection	Yes; Type 1 protection
• Military testing according to MIL-I-46058C, Amendment 7	Yes; Discoloration of coating possible during service life	Yes; Discoloration of coating possible during service life
• Qualification and Performance of Electrical Insulating Compound for Printed Board Assemblies according to IPC-CC-830A	Yes; Conformal coating, Class A	Yes; Conformal coating, Class A

Ordering data	Article No.
SIPLUS CPU 1512SP-1 PN (Extended temperature range and medial exposure) Work memory 200 KB for program, 1 MB for data, PROFINET IO IRT interface; SIMATIC Memory Card required Temperature range -40 ... +60 °C Temperature range -40 ... +70 °C; No BusAdapter can be inserted	 6AG1512-1DK01-2AB0 6AG1512-1DK01-7AB0
Accessories	
BA 2xRJ45 BusAdapter (Extended temperature range and medial exposure)	6AG1193-6AR00-7AA0
BA 2xFC BusAdapter for increased vibration and EMC loads (Extended temperature range and medial exposure)	6AG1193-6AF00-7AA0
IE FC RJ45 plugs RJ45 plug connector for Industrial Ethernet with a rugged metal enclosure and integrated insulation displacement contacts for connecting Industrial Ethernet FC installation cables	
IE FC RJ45 plug 180 180° cable outlet 1 unit	6AG1901-1BB10-7AA0
Other accessories	See SIMATIC ET 200SP, CPU 1512SP-1 PN, catalog ST 70 · 2019, page 7/8

Distributed Controllers

based on ET 200SP

ET 200SP Open Controllers

Technology CPUs > CPU 1515SP PC2 T

Overview



ET 200SP Open Controller CPU 1515SP PC2 T combines robustness and compact dimensions with the flexibility of centralized or decentralized communication in the highest industrial functionality. Furthermore, the CPU offers the entire value added of the ET 200SP system, the S7-1500 controller family and the TIA world together.

- Rugged, compact control system
- Combines the functions of an ET 200SP controller with those of a PC-based platform
- Turnkey all-in-one controller
- High performance automation tasks with the use of new generation Intel Quad Core processors
- Connects high-level language applications and processes high data volumes with support from SIMATIC ODK 1500S

7

Technical specifications

Article number	6ES7677-2VB42-0GB0 CPU1515SP PC2 T
General information	
Product type designation	CPU 1515SP PC2 T
Engineering with	
• STEP 7 TIA Portal configurable/integrated as of version	V15 (FW V2.5)
Installed software	
• Visualization	No
• Control	S7-1500 Software Controller CPU 1505SP T
Supply voltage	
Type of supply voltage	24 V DC
Processor	
Processor type	Intel Atom E3940, 1.6 GHz, 4 cores
Memory	
Type of memory	DDR3L
Main memory	8 GB RAM
CFast memory card	Yes; 30 GB flash memory
Work memory	
• integrated (for program)	1 Mbyte
• integrated (for data)	5 Mbyte
• integrated (for CPU function library of CPU Runtime)	20 Mbyte
Load memory	
• integrated (on PC mass storage)	320 Mbyte
CPU processing times	
for bit operations, typ.	10 ns
for word operations, typ.	12 ns
for fixed point arithmetic, typ.	16 ns
for floating point arithmetic, typ.	64 ns
Counters, timers and their retentivity	
S7 counter	
• Number	2 048
IEC counter	
• Number	Any (only limited by the main memory)

Article number	6ES7677-2VB42-0GB0 CPU1515SP PC2 T
S7 times	
• Number	2 048
IEC timer	
• Number	Any (only limited by the main memory)
Data areas and their retentivity	
Flag	
• Number, max.	16 kbyte
Address area	
I/O address area	
• Inputs	32 kbyte; All inputs are in the process image
• Outputs	32 kbyte; All outputs are in the process image
Hardware configuration	
Integrated power supply	Yes
Time of day	
Clock	
• Type	Hardware clock
• Hardware clock (real-time)	Yes; Resolution: 1 s
Interfaces	
Number of industrial Ethernet interfaces	2
Number of RS 485 interfaces	1; Via CM DP module
Number of USB interfaces	4; 2x USB 2.0, 2x USB 3.0 on front side
Number of SD card slots	1
Video interfaces	
• Graphics interface	1x DisplayPort
1. Interface	
Interface type	PROFINET
automatic detection of transmission rate	Yes
Autonegotiation	Yes
Autocrossing	Yes
Number of connections	88

Technical specifications

Article number	6ES7677-2VB42-0GB0 CPU1515SP PC2 T
Interface types	
• Number of ports	2
• integrated switch	Yes
• RJ 45 (Ethernet)	Yes; Via BusAdapter BA 2x RJ45
- Transmission rate, max.	100 Mbit/s
- Industrial Ethernet status LED	Yes
• BusAdapter (PROFINET)	Yes; Compatible BusAdapter: BA 2x RJ45, BA 2x FC, BA 2x SCRJ (from FS03, V2.2), BA SCRJ / RJ45 (from FS03, V3.1), BA SCRJ / FC (from FS03, V3.1), BA 2x LC (from FS03, V3.3), BA LC / RJ45 (from FS03, V3.3), BA LC / FC (from FS03, V3.3)
Protocols	
• PROFINET IO Controller	Yes
• PROFINET IO Device	Yes
• SIMATIC communication	Yes
• Open IE communication	Yes
• Web server	Yes
PROFINET IO Controller	
Services	
- Isochronous mode	Yes
- shortest clock pulse	500 µs
- IRT	Yes
- MRP	Yes
- MRPD	Yes
- PROFIenergy	Yes
- Prioritized startup	Yes; Max. 32 PROFINET devices; if you want to use the "Prioritized startup" functionality in STEP 7 for the PROFINET interface of the CPU, the CPU and the device must be separated by means of a switch (e.g. SCALANCE X205)
- Number of connectable IO Devices, max.	128
- Of which IO devices with IRT, max.	64
- of which in line, max.	64
- Number of connectable IO Devices for RT, max.	128
- of which in line, max.	128
- Number of IO Devices that can be simultaneously activated/deactivated, max.	8
- IO Devices changing during operation (partner ports), supported	Yes
- Number of IO Devices per tool, max.	8
- Updating times	The minimum value of the update time also depends on communica- tion share set for PROFINET IO, on the number of IO devices, and on the quantity of configured user data
Update time for IRT	
- for send cycle of 500 µs	500 µs to 8 ms
- for send cycle of 1 ms	1 ms to 16 ms
- for send cycle of 2 ms	2 ms to 32 ms
- for send cycle of 4 ms	4 ms to 64 ms
- With IRT and parameterization of "odd" send cycles	Update time = set "odd" send clock (any multiple of 125 µs: 375 µs, 625 µs ... 3 875 µs)

Article number	6ES7677-2VB42-0GB0 CPU1515SP PC2 T
Update time for RT	
- for send cycle of 500 µs	500 µs to 256 ms
- for send cycle of 1 ms	1 ms to 512 ms
- for send cycle of 2 ms	2 ms to 512 ms
- for send cycle of 4 ms	4 ms to 512 ms
Address area	
- Inputs, max.	8 kbyte
- Outputs, max.	8 kbyte
PROFINET IO Device	
Services	
- Isochronous mode	No
- shortest clock pulse	500 µs
- IRT	Yes
- MRP	Yes
- MRPD	Yes
- PROFIenergy	Yes
- Prioritized startup	Yes
- Shared device	Yes
- Number of IO Controllers with shared device, max.	4
- Asset management record	Yes
2. Interface	
Interface type	Integrated Ethernet interface
automatic detection of transmission rate	Yes
Autonegotiation	Yes
Autocrossing	Yes
Interface types	
• Number of ports	1
• RJ 45 (Ethernet)	Yes; Integrated
- Transmission rate, max.	1 000 Mbit/s
- Industrial Ethernet status LED	No
3. Interface	
Interface type	PROFIBUS with CM DP
Number of connections via this interface	44
Interface types	
• RS 485	Yes
Protocols	
• PROFIBUS DP master	Yes
• PROFIBUS DP slave	Yes
• SIMATIC communication	Yes
PROFIBUS DP master	
• Number of DP slaves, max.	125
Services	
- Equidistance	No
- Isochronous mode	No
Address area	
- Inputs, max.	8 kbyte
- Outputs, max.	8 kbyte
PROFIBUS DP slave	
Services	
- Equidistance	No
- Isochronous mode	No

Distributed Controllers

based on ET 200SP

ET 200SP Open Controllers

Technology CPUs > CPU 1515SP PC2 T

Technical specifications

Article number	6ES7677-2VB42-0GB0 CPU1515SP PC2 T
Protocols	
Number of connections	
• Number of connections, max.	88
OPC UA	
• OPC UA client	Yes; From SW CPU 1505SP V2.6
• OPC UA server	Yes; Data access (read, write, subscribe), runtime license required
Supported technology objects	
Motion Control	Yes
• Number of available Motion Control resources for technology objects	2 400
• Required Motion Control resources	
- per speed-controlled axis	40; per axis
- per positioning axis	80; per axis
- per synchronous axis	160; per axis
- per external encoder	80; per external encoder
- per output cam	20; per cam
- per cam track	160; per cam track
- per probe	40; per probe
• Number of available Extended Motion Control resources for technology objects	120
• Required Extended Motion Control resources	
- for each cam	2
- for each set of kinematics	30
Controller	
• PID_Compact	Yes; Universal PID controller with integrated optimization
• PID_3Step	Yes; PID controller with integrated optimization for valves
• PID-Temp	Yes; PID controller with integrated optimization for temperature
Counting and measuring	
• High-speed counter	Yes
Ambient conditions	
Ambient temperature during operation	
• min.	-20 °C
• max.	Up to 60 °C with max. 32 ET 200SP modules; up to 55 °C with max. 64 ET 200SP modules
• horizontal installation, min.	-20 °C
• horizontal installation, max.	60 °C
• vertical installation, min.	-20 °C
• vertical installation, max.	50 °C; With max. 32 ET 200SP modules

Article number	6ES7677-2VB42-0GB0 CPU1515SP PC2 T
Operating systems	
pre-installed operating system	Windows 10 IoT Enterprise 2016 LTSC, 64bit, MUI
Configuration	
Programming	
Programming language	
- LAD	Yes
- FBD	Yes
- STL	Yes
- SCL	Yes
- CFC	No
- GRAPH	Yes
Know-how protection	
• User program protection/password protection	Yes
• Copy protection	Yes
• Block protection	Yes
Access protection	
• Protection level: Write protection	Yes
• Protection level: Read/write protection	Yes
• Protection level: Complete protection	Yes
Open Development interfaces	
• Size of ODK SO file, max.	5.8 Mbyte
Peripherals/Options	
SD card	Optionally for additional mass storage
Dimensions	
Width	160 mm
Height	117 mm
Depth	75 mm
Weights	
Weight, approx.	0.83 kg

7

Ordering data	Article No.	Article No.
SIMATIC ET 200SP Open Controller CPU 1515SP PC2 T ET 200SP central module with Windows 10 IoT Enterprise 64-bit and pre-installed SIMATIC S7-1500 Software Controller (with WinCC RT Advanced option); 8 GB RAM, 128 GB CFast card; with extended Motion Control functionality Type of delivery: en, de, fr, it, es, zh • CPU 1515SP PC2 T With pre-installed WinCC RT Advanced • CPU 1515SP PC2 T + HMI 128PT • CPU 1515SP PC2 T + HMI 512PT • CPU 1515SP PC2 T + HMI 2048PT	6ES7677-2VB42-0GB0 6ES7677-2VB42-0GK0 6ES7677-2VB42-0GL0 6ES7677-2VB42-0GM0	STEP 7 Professional V16 Target system: SIMATIC S7-1200, S7-1500, S7-300, S7-400, WinAC Requirement: Windows 7 Professional SP1 Windows 7 Enterprise SP1 Windows 7 Ultimate SP1 Windows 10 Professional Version 1809, 1903 Windows 10 Enterprise Version 1809, 1903 Windows 10 IoT Enterprise 2015 LTSB Windows 10 IoT Enterprise 2016 LTSB Windows 10 IoT Enterprise 2019 LTSC Windows Server 2012 R2 StdE (full installation) Windows Server 2016 Standard (full installation) Windows Server 2019 Standard (full installation) Type of delivery: German, English, Chinese, Italian, French, Spanish STEP 7 Professional V16, floating license STEP 7 Professional V16, floating license, software download including license key ¹⁾ Email address required for delivery
Accessories		
BusAdapter BA 2xRJ45	6ES7193-6AR00-0AA0	
BusAdapter BA 2xFC	6ES7193-6AF00-0AA0	
BusAdapter BA 2xSCRJ	6ES7193-6AP00-0AA0	
BusAdapter BA SCRJ/RJ45	6ES7193-6AP20-0AA0	6ES7822-1AA06-0YA5
BusAdapter BA SCRJ/FC	6ES7193-6AP40-0AA0	6ES7822-1AE06-0YA5
For increased vibration and EMC loads		
BusAdapter BA 2XLC	6ES7193-6AG00-0AA0	
BusAdapter BA LC/RJ45	6ES7193-6AG20-0AA0	
BusAdapter BA LC/FC	6ES7193-6AG40-0AA0	
CM DP for ET 200SP CPU	6ES7545-5DA00-0AB0	
PROFIBUS DP master with electrical interface for connecting the ET 200SP CPUs to PROFIBUS at up to 12 Mbps		
Server module	6ES7193-6PA00-0AA0	
Spare part		
Power supply connector	6ES7193-4JB00-0AA0	
Spare part; for connecting the 24 V DC supply voltage; with push-in terminals (10 units)		
Equipment labeling plate	6ES7193-6LF30-0AW0	
10 sheets of 16 plates		
Labeling strips		
500 labeling strips on roll, light gray, for inscription with thermal transfer roll printer	6ES7193-6LR10-0AA0	6AV2102-0AA06-0AA5
1 000 labeling strips DIN A4, light gray, card, for inscription with laser printer	6ES7193-6LA10-0AA0	6AV2102-0AA06-0AH5
		SIMATIC ODK 1500S Open Development Kit for support in developing Windows and real-time library functions for S7-1500 Software Controllers; supplied on DVD Open Development Kit for support in developing Windows and real-time library functions for S7-1500 Software Controllers; software download including license key ¹⁾ Email address required for delivery WinCC Advanced V16 Engineering software in the TIA Portal; in 6 languages: de, en, fr, es, it, zh; for configuring SIMATIC Panels, WinCC Runtime Advanced, WinCC Unified PC Runtime • Floating license; software and documentation on DVD; license key on USB flash drive • Floating license; software, documentation and license key for download ¹⁾; email address required for delivery

¹⁾ For up-to-date information and download availability, see: <http://www.siemens.com/tia-online-software-delivery>

Distributed Controllers

based on ET 200SP

ET 200SP Open Controllers

Technology CPUs > CPU 1515SP PC2 TF

Overview

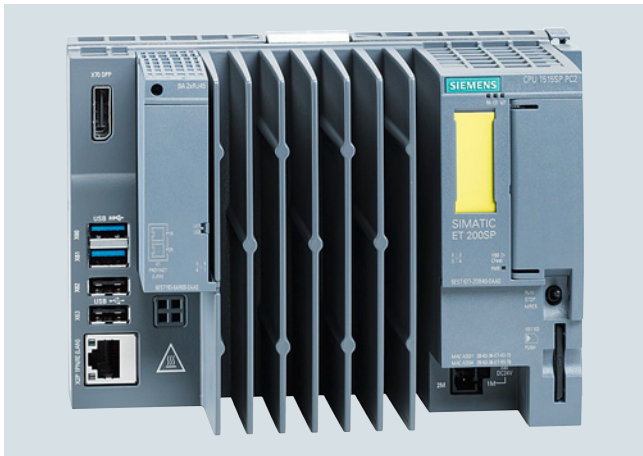

ET 200SP Open Controller, CPU 1515SP PC2 TF, combines robustness and compact dimensions with the flexibility of centralized or decentralized communication in the highest industrial functionality. Furthermore, the CPU offers the entire value added of the ET 200SP system, the S7-1500 controller family and the TIA world together.

- Rugged, compact control system
- Combines the functions of a ET 200SP controller with those of a PC-based platform
- Turnkey all-in-one controller
- Can be used up to safety class SIL3 (Safety Integrity Level) according to IEC 61508 2nd Edition or PL e (Performance Level) according to ISO 13849
- High performance automation tasks with the use of new generation Intel Quad Core processors
- Connects high-level language applications and processes high data volumes with support from SIMATIC ODK 1500S

7

Technical specifications

Article number	6ES7677-2WB42-0GB0 CPU1515SP PC2 TF
General information	
Product type designation	CPU 1515SP PC2 TF
Engineering with	
• STEP 7 TIA Portal configurable/integrated as of version	V15 (FW V2.5)
Installed software	
• Visualization	No
• Control	S7-1500 Software Controller CPU 1505SP TF
Supply voltage	
Type of supply voltage	24 V DC
Processor	
Processor type	Intel Atom E3940, 1.6 GHz, 4 cores
Memory	
Type of memory	DDR3L
Main memory	8 GB RAM
CFast memory card	Yes; 30 GB flash memory
Work memory	
• integrated (for program)	1.5 Mbyte
• integrated (for data)	5 Mbyte
• integrated (for CPU function library of CPU Runtime)	20 Mbyte
Load memory	
• integrated (on PC mass storage)	320 Mbyte
CPU processing times	
for bit operations, typ.	10 ns
for word operations, typ.	12 ns
for fixed point arithmetic, typ.	16 ns
for floating point arithmetic, typ.	64 ns
Counters, timers and their retentivity	
S7 counter	
• Number	2 048
IEC counter	
• Number	Any (only limited by the main memory)

Article number	6ES7677-2WB42-0GB0 CPU1515SP PC2 TF
S7 times	
• Number	2 048
IEC timer	
• Number	Any (only limited by the main memory)
Data areas and their retentivity	
Flag	
• Number, max.	16 kbyte
Address area	
I/O address area	
• Inputs	32 kbyte; All inputs are in the process image
• Outputs	32 kbyte; All outputs are in the process image
Hardware configuration	
Integrated power supply	Yes
Time of day	
Clock	
• Type	Hardware clock
• Hardware clock (real-time)	Yes; Resolution: 1 s
Interfaces	
Number of industrial Ethernet interfaces	2
Number of RS 485 interfaces	1; Via CM DP module
Number of USB interfaces	4; 2x USB 2.0, 2x USB 3.0 on front side
Number of SD card slots	1
Video interfaces	
• Graphics interface	1x DisplayPort
1. Interface	
Interface type	PROFINET
automatic detection of transmission rate	Yes
Autonegotiation	Yes
Autocrossing	Yes
Number of connections	88

Technical specifications

Article number	6ES7677-2WB42-0GB0 CPU1515SP PC2 TF
Interface types	
• Number of ports	2
• integrated switch	Yes
• RJ 45 (Ethernet)	Yes; Via BusAdapter BA 2x RJ45
- Transmission rate, max.	100 Mbit/s
- Industrial Ethernet status LED	Yes
• BusAdapter (PROFINET)	Yes; Compatible BusAdapter: BA 2x RJ45, BA 2x FC, BA 2x SCRJ (from FS03, V2.2), BA SCRJ / RJ45 (from FS03, V3.1), BA SCRJ / FC (from FS03, V3.1), BA 2x LC (from FS03, V3.3), BA LC / RJ45 (from FS03, V3.3), BA LC / FC (from FS03, V3.3)
Protocols	
• PROFINET IO Controller	Yes
• PROFINET IO Device	Yes
• SIMATIC communication	Yes
• Open IE communication	Yes
• Web server	Yes
PROFINET IO Controller	
Services	
- Isochronous mode	Yes
- shortest clock pulse	500 µs
- IRT	Yes
- MRP	Yes
- MRPD	Yes
- PROFIenergy	Yes
- Prioritized startup	Yes; Max. 32 PROFINET devices; if you want to use the "Prioritized startup" functionality in STEP 7 for the PROFINET interface of the CPU, the CPU and the device must be separated by means of a switch (e.g. SCALANCE X205)
- Number of connectable IO Devices, max.	128
- Of which IO devices with IRT, max.	64
- of which in line, max.	64
- Number of connectable IO Devices for RT, max.	128
- of which in line, max.	128
- Number of IO Devices that can be simultaneously activated/deactivated, max.	8
- IO Devices changing during operation (partner ports), supported	Yes
- Number of IO Devices per tool, max.	8
- Updating times	The minimum value of the update time also depends on communica- tion share set for PROFINET IO, on the number of IO devices, and on the quantity of configured user data
Update time for IRT	
- for send cycle of 500 µs	500 µs to 8 ms
- for send cycle of 1 ms	1 ms to 16 ms
- for send cycle of 2 ms	2 ms to 32 ms
- for send cycle of 4 ms	4 ms to 64 ms
- With IRT and parameterization of "odd" send cycles	Update time = set "odd" send clock (any multiple of 125 µs: 375 µs, 625 µs ... 3 875 µs)

Article number	6ES7677-2WB42-0GB0 CPU1515SP PC2 TF
Update time for RT	
- for send cycle of 500 µs	500 µs to 256 ms
- for send cycle of 1 ms	1 ms to 512 ms
- for send cycle of 2 ms	2 ms to 512 ms
- for send cycle of 4 ms	4 ms to 512 ms
Address area	
- Inputs, max.	8 kbyte
- Outputs, max.	8 kbyte
PROFINET IO Device	
Services	
- Isochronous mode	No
- shortest clock pulse	500 µs
- IRT	Yes
- MRP	Yes
- MRPD	Yes
- PROFIenergy	Yes
- Prioritized startup	Yes
- Shared device	Yes
- Number of IO Controllers with shared device, max.	4
- Asset management record	Yes
2. Interface	
Interface type	Integrated Ethernet interface
automatic detection of transmission rate	Yes
Autonegotiation	Yes
Autocrossing	Yes
Interface types	
• Number of ports	1
• RJ 45 (Ethernet)	Yes; Integrated
- Transmission rate, max.	1 000 Mbit/s
- Industrial Ethernet status LED	No
3. Interface	
Interface type	PROFIBUS with CM DP
Number of connections via this interface	44
Interface types	
• RS 485	Yes
Protocols	
• PROFIBUS DP master	Yes
• PROFIBUS DP slave	Yes
• SIMATIC communication	Yes
PROFIBUS DP master	
• Number of DP slaves, max.	125
Services	
- Equidistance	No
- Isochronous mode	No
Address area	
- Inputs, max.	8 kbyte
- Outputs, max.	8 kbyte
PROFIBUS DP slave	
Services	
- Equidistance	No
- Isochronous mode	No

Distributed Controllers

based on ET 200SP

ET 200SP Open Controllers

Technology CPUs > CPU 1515SP PC2 TF

Technical specifications

Article number	6ES7677-2WB42-0GB0 CPU1515SP PC2 TF
Protocols	
Number of connections	
• Number of connections, max.	88
OPC UA	
• OPC UA client	Yes; From SW CPU 1505SP V2.6
• OPC UA server	Yes; Data access (read, write, subscribe), runtime license required
Supported technology objects	
Motion Control	Yes
• Number of available Motion Control resources for technology objects	2 400
• Required Motion Control resources	
- per speed-controlled axis	40; per axis
- per positioning axis	80; per axis
- per synchronous axis	160; per axis
- per external encoder	80; per external encoder
- per output cam	20; per cam
- per cam track	160; per cam track
- per probe	40; per probe
• Number of available Extended Motion Control resources for technology objects	120
• Required Extended Motion Control resources	
- for each cam	2
- for each set of kinematics	30
Controller	
• PID_Compact	Yes; Universal PID controller with integrated optimization
• PID_3Step	Yes; PID controller with integrated optimization for valves
• PID-Temp	Yes; PID controller with integrated optimization for temperature
Counting and measuring	
• High-speed counter	Yes
Standards, approvals, certificates	
Highest safety class achievable in safety mode	
• Performance level according to ISO 13849-1	PLe
• SIL acc. to IEC 61508	SIL 3
Probability of failure (for service life of 20 years and repair time of 100 hours)	
- Low demand mode: PFDavg in accordance with SIL3	< 2.00E-05
- High demand/continuous mode: PFH in accordance with SIL3	< 1.00E-09 1/h

Article number	6ES7677-2WB42-0GB0 CPU1515SP PC2 TF
Ambient conditions	
Ambient temperature during operation	
• min.	-20 °C
• max.	Up to 60 °C with max. 32 ET 200SP modules; up to 55 °C with max. 64 ET 200SP modules
• horizontal installation, min.	-20 °C
• horizontal installation, max.	60 °C
• vertical installation, min.	-20 °C
• vertical installation, max.	50 °C; With max. 32 ET 200SP modules
Operating systems	
pre-installed operating system	Windows 10 IoT Enterprise 2016 LTSC, 64bit, MUI
Configuration	
Programming	
Programming language	
- LAD	Yes; incl. failsafe
- FBD	Yes; incl. failsafe
- STL	Yes
- SCL	Yes
- CFC	No
- GRAPH	Yes
Know-how protection	
• User program protection/password protection	Yes
• Copy protection	Yes
• Block protection	Yes
Access protection	
• Protection level: Write protection	Yes
• Protection level: Read/write protection	Yes
• Protection level: Complete protection	Yes
Open Development interfaces	
• Size of ODK SO file, max.	5.8 Mbyte
Peripherals/Options	
SD card	Optionally for additional mass storage
Dimensions	
Width	160 mm
Height	117 mm
Depth	75 mm
Weights	
Weight, approx.	0.83 kg

7

Distributed Controllers

based on ET 200SP

SIPLUS ET 200SP Open Controllers

SIPLUS standard CPUs > SIPLUS CPU 1515SP PC2

Overview



SIPLUS ET 200SP Open Controller, SIPLUS CPU 1515SP PC2, combines robustness and compact dimensions with the flexibility of centralized or decentralized communication in the highest industrial functionality. Furthermore, the CPU offers the entire value added of the SIPLUS ET 200SP system, the SIPLUS S7-1500 controller family and the TIA world together.

- Rugged, compact control system
- Combines the functions of a SIPLUS ET 200SP controller with those of a PC-based platform
- Turnkey all-in-one controller
- High performance automation tasks with the use of new generation Intel Quad Core processors
- Connects high-level language applications and processes high data volumes with support from SIMATIC ODK 1500S

Note

SIPLUS extreme products are based on SIMATIC standard products. The contents listed here were adopted from the respective standard products. SIPLUS extreme-specific information was added.

Technical specifications

Article number	6AG1677-2DB42-2GB0	6AG1677-2DB40-2AA0
Based on	6ES7677-2DB42-0GB0 SIPLUS ET 200SP CPU1515SP PC2	6AG1677-2DB40-0AA0 SIPLUS ET 200SP CPU1515SP PC2
Ambient conditions		
Ambient temperature during operation		
• min.	-40 °C; = Tmin (incl. condensation/frost)	-40 °C; = Tmin (incl. condensation/frost)
• max.	Up to 60 °C with max. 32 ET 200SP modules; up to 55 °C with max. 64 ET 200SP modules	Up to 60 °C with max. 32 ET 200SP modules; up to 55 °C with max. 64 ET 200SP modules
• horizontal installation, min.	-40 °C; = Tmin (incl. condensation/frost)	-40 °C; = Tmin (incl. condensation/frost)
• horizontal installation, max.	60 °C; = Tmax	60 °C; = Tmax
• vertical installation, min.	-40 °C; = Tmin (incl. condensation/frost)	-40 °C; = Tmin (incl. condensation/frost)
• vertical installation, max.	50 °C; With max. 32 ET 200SP modules	50 °C; With max. 32 ET 200SP modules
Altitude during operation relating to sea level		
• Installation altitude above sea level, max.	2 000 m	2 000 m
• Ambient air temperature-barometric pressure-altitude	Tmin ... Tmax at 1 140 hPa ... 795 hPa (-1 000 m ... +2 000 m)	Tmin ... Tmax at 1 140 hPa ... 795 hPa (-1 000 m ... +2 000 m)
Relative humidity		
• With condensation, tested in accordance with IEC 60068-2-38, max.	100 %; RH incl. condensation / frost (no commissioning in bedewed state), horizontal installation	100 %; RH incl. condensation / frost (no commissioning in bedewed state), horizontal installation
Resistance		
Coolants and lubricants		
- Resistant to commercially available coolants and lubricants	Yes; Incl. diesel and oil droplets in the air	Yes; Incl. diesel and oil droplets in the air
Use in stationary industrial systems		
- to biologically active substances according to EN 60721-3-3	Yes; Class 3B2 mold, fungus and dry rot spores (with the exception of fauna); Class 3B3 on request	Yes; Class 3B2 mold, fungus and dry rot spores (with the exception of fauna); Class 3B3 on request
- to chemically active substances according to EN 60721-3-3	Yes; Class 3C4 (RH < 75 %) incl. salt spray acc. to EN 60068-2-52 (severity degree 3); *	Yes; Class 3C4 (RH < 75 %) incl. salt spray acc. to EN 60068-2-52 (severity degree 3); *
- to mechanically active substances according to EN 60721-3-3	Yes; Class 3S4 incl. sand, dust, *	Yes; Class 3S4 incl. sand, dust, *
- Against mechanical environmental conditions acc. to EN 60721-3-3	Yes; Class 3M8 using the SIPLUS Mounting Kit ET 200SP (6AG1193-6AA00-0AA0)	Yes; Class 3M8 using the SIPLUS Mounting Kit ET 200SP (6AG1193-6AA00-0AA0)

Technical specifications

Article number	6AG1677-2DB42-2GB0	6AG1677-2DB40-2AA0
Based on	6ES7677-2DB42-0GB0 SIPLUS ET 200SP CPU1515SP PC2	6AG1677-2DB40-0AA0 SIPLUS ET 200SP CPU1515SP PC2
Use on ships/at sea		
- to biologically active substances according to EN 60721-3-6	Yes; Class 6B2 mold, fungal and dry rot spores (excluding fauna)	Yes; Class 6B2 mold, fungal and dry rot spores (excluding fauna)
- to chemically active substances according to EN 60721-3-6	Yes; Class 6C3 (RH < 75 %) incl. salt spray acc. to EN 60068-2-52 (severity degree 3); *	Yes; Class 6C3 (RH < 75 %) incl. salt spray acc. to EN 60068-2-52 (severity degree 3); *
- to mechanically active substances according to EN 60721-3-6	Yes; Class 6S3 incl. sand, dust; *	Yes; Class 6S3 incl. sand, dust; *
- Against mechanical environmental conditions acc. to EN 60721-3-6	Yes; Class 6M4 using the SIPLUS Mounting Kit ET 200SP (6AG1193-6AA00-0AA0)	Yes; Class 6M4 using the SIPLUS Mounting Kit ET 200SP (6AG1193-6AA00-0AA0)
Usage in industrial process technology		
- Against chemically active substances acc. to EN 60654-4	Yes; Class 3 (excluding trichlorethylene)	Yes; Class 3 (excluding trichlorethylene)
- Environmental conditions for process, measuring and control systems acc. to ANSI/ISA-71.04	Yes; Level GX group A/B (excluding trichlorethylene; harmful gas concentrations up to the limits of EN 60721-3-3 class 3C4 permissible); level LC3 (salt spray) and level LB3 (oil)	Yes; Level GX group A/B (excluding trichlorethylene; harmful gas concentrations up to the limits of EN 60721-3-3 class 3C4 permissible); level LC3 (salt spray) and level LB3 (oil)
Remark		
- Note regarding classification of environmental conditions acc. to EN 60721, EN 60654-4 and ANSI/ISA-71.04	* The supplied plug covers must remain in place over the unused interfaces during operation!	* The supplied plug covers must remain in place over the unused interfaces during operation!
Conformal coating		
• Coatings for printed circuit board assemblies acc. to EN 61086	Yes; Class 2 for high availability	Yes; Class 2 for high availability
• Protection against fouling acc. to EN 60664-3	Yes; Type 1 protection	Yes; Type 1 protection
• Military testing according to MIL-I-46058C, Amendment 7	Yes; Discoloration of coating possible during service life	Yes; Discoloration of coating possible during service life
• Qualification and Performance of Electrical Insulating Compound for Printed Board Assemblies according to IPC-CC-830A	Yes; Conformal coating, Class A	Yes; Conformal coating, Class A

Ordering data

SIPLUS ET 200SP Open Controller – CPU 1515SP PC2

(Extended temperature range and exposure to media)

SIPLUS ET 200SP CPU with Windows 10 IoT Enterprise 64-bit and pre-installed SIMATIC S7-1500 Software Controller; 8 GB RAM, 30 GB CFast card

Type of delivery:

English, German, Chinese, Italian, French, Spanish

• SIPLUS CPU 1515SP PC2

Spare part, without CFast card

• SIPLUS CPU 1515SP PC2

Article No.

6AG1677-2DB42-2GB0

6AG1677-2DB40-2AA0

Article No.

Accessories

BusAdapter BA 2xRJ45

(Extended temperature range and exposure to media)

6AG1193-6AR00-7AA0

SIPLUS BusAdapter BA 2xFC

(Extended temperature range and exposure to media)

6AG1193-6AF00-7AA0

BusAdapter BA 2xSCRJ

(Extended temperature range and exposure to media)

6AG1193-6AP00-2AA0

BusAdapter BA 2xLC

(Extended temperature range and exposure to media)

6AG1193-6AG00-2AA0

Further accessories

See SIMATIC CPU 1515SP PC2, catalog ST 70 · 2019, page 7/37

Distributed Controllers

based on ET 200SP

SIPLUS ET 200SP Open Controllers

SIPLUS fail-safe CPUs > SIPLUS CPU 1515SP PC2 F

Overview

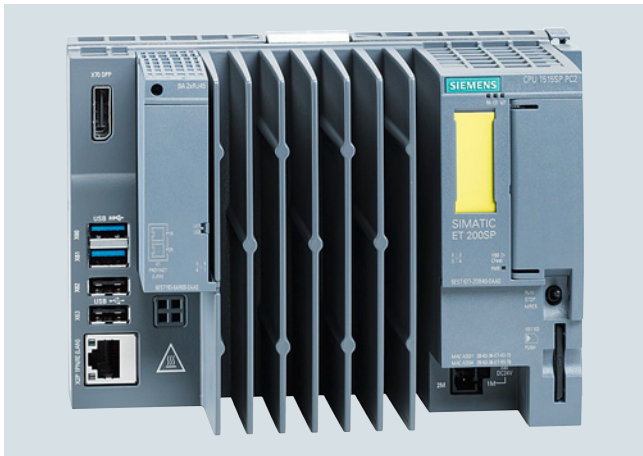

SIPLUS ET 200SP Open Controller, SIPLUS CPU 1515SP PC2 F, combines robustness and compact dimensions with the flexibility of centralized or decentralized communication in the highest industrial functionality. Furthermore, the CPU offers the entire value added of the SIPLUS ET 200SP system, the SIPLUS S7-1500 controller family and the TIA world together.

- Rugged, compact control system
- Combines the functions of a SIPLUS ET 200SP controller with those of a PC-based platform
- Turnkey all-in-one controller
- Can be used up to safety class SIL3 (Safety Integrity Level) according to IEC 61508 2nd Edition or PL e (Performance Level) according to ISO 13849
- High performance automation tasks with the use of new generation Intel Quad Core processors
- Connects high-level language applications and processes high data volumes with support from SIMATIC ODK 1500S

Note

SIPLUS extreme products are based on SIMATIC standard products. The contents listed here were adopted from the respective standard products. SIPLUS extreme-specific information was added.

Technical specifications

Article number	6AG1677-2SB42-2GB0
Based on	6ES7677-2SB42-0GB0 SIPLUS ET 200SP CPU1515SP PC2 F
Ambient conditions	
Ambient temperature during operation	
• min.	-40 °C; = Tmin (incl. condensation/frost)
• max.	60 °C; Up to 60 °C with max. 32 ET 200SP modules; up to 55 °C with max. 64 ET 200SP modules
• horizontal installation, min.	-40 °C; = Tmin (incl. condensation/frost)
• horizontal installation, max.	60 °C; = Tmax
• vertical installation, min.	-40 °C; = Tmin (incl. condensation/frost)
• vertical installation, max.	50 °C; With max. 32 ET 200SP modules
Altitude during operation relating to sea level	
• Installation altitude above sea level, max.	2 000 m
• Ambient air temperature-barometric pressure-altitude	Tmin ... Tmax at 1 140 hPa ... 795 hPa (-1 000 m ... +2 000 m)
Relative humidity	
• With condensation, tested in accordance with IEC 60068-2-38, max.	100 %; RH incl. condensation / frost (no commissioning in bedewed state), horizontal installation
Resistance	
Coolants and lubricants	
- Resistant to commercially available coolants and lubricants	Yes; Incl. diesel and oil droplets in the air

Article number	6AG1677-2SB42-2GB0
Based on	6ES7677-2SB42-0GB0 SIPLUS ET 200SP CPU1515SP PC2 F
Use in stationary industrial systems	
- to biologically active substances according to EN 60721-3-3	Yes; Class 3B2 mold, fungus and dry rot spores (with the exception of fauna); Class 3B3 on request
- to chemically active substances according to EN 60721-3-3	Yes; Class 3C4 (RH < 75 %) incl. salt spray acc. to EN 60068-2-52 (severity degree 3); *
- to mechanically active substances according to EN 60721-3-3	Yes; Class 3S4 incl. sand, dust, *
- Against mechanical environmental conditions acc. to EN 60721-3-3	Yes; Class 3M8 using the SIPLUS Mounting Kit ET 200SP (6AG1193-6AA00-0AA0)
Use on ships/at sea	
- to biologically active substances according to EN 60721-3-6	Yes; Class 6B2 mold, fungal and dry rot spores (excluding fauna)
- to chemically active substances according to EN 60721-3-6	Yes; Class 6C3 (RH < 75 %) incl. salt spray acc. to EN 60068-2-52 (severity degree 3); *
- to mechanically active substances according to EN 60721-3-6	Yes; Class 6S3 incl. sand, dust; *
- Against mechanical environmental conditions acc. to EN 60721-3-6	Yes; Class 6M4 using the SIPLUS Mounting Kit ET 200SP (6AG1193-6AA00-0AA0)
Usage in industrial process technology	
- Against chemically active substances acc. to EN 60654-4	Yes; Class 3 (excluding trichlorethylene)
- Environmental conditions for process, measuring and control systems acc. to ANSI/ISA-71.04	Yes; Level GX group A/B (excluding trichlorethylene; harmful gas concentrations up to the limits of EN 60721-3-3 class 3C4 permissible); level LC3 (salt spray) and level LB3 (oil)

Technical specifications		Ordering data	Article No.
Article number	6AG1677-2SB42-2GB0	SIPLUS ET 200SP Open Controller CPU 1515SP PC2 F	
Based on	6ES7677-2SB42-0GB0 SIPLUS ET 200SP CPU1515SP PC2 F		
Remark		(Extended temperature range and exposure to media)	
- Note regarding classification of environmental conditions acc. to EN 60721, EN 60654-4 and ANSI/ISA-71.04	* The supplied plug covers must remain in place over the unused interfaces during operation!	Fail-safe ET 200SP CPU with Windows 10 IoT Enterprise 64-bit and pre-installed SIMATIC S7-1500 Failsafe Software Controller (with WinCC RT Advanced option); 8 GB RAM, 30 GB CFast card;	
Conformal coating		Type of delivery: English, German, Chinese, Italian, French, Spanish	
• Coatings for printed circuit board assemblies acc. to EN 61086	Yes; Class 2 for high availability	• SIPLUS CPU 1515SP PC2 F	6AG1677-2SB42-2GB0
• Protection against fouling acc. to EN 60664-3	Yes; Type 1 protection	Accessories	
• Military testing according to MIL-I-46058C, Amendment 7	Yes; Discoloration of coating possible during service life	BusAdapter BA 2xRJ45	6AG1193-6AR00-7AA0
• Qualification and Performance of Electrical Insulating Compound for Printed Board Assemblies according to IPC-CC-830A	Yes; Conformal coating, Class A	(Extended temperature range and exposure to media)	
		SIPLUS BusAdapter BA 2xFC	6AG1193-6AF00-7AA0
		(Extended temperature range and exposure to media)	
		BusAdapter BA 2xSCRJ	6AG1193-6AP00-2AA0
		(Extended temperature range and exposure to media)	
		BusAdapter BA 2xLC	6AG1193-6AG00-2AA0
		(Extended temperature range and exposure to media)	
		Further accessories	See SIMATIC CPU 1515SP PC2 F, catalog ST 70 · 2019, page 7/47

Distributed Controllers

based on ET 200Pro
Standard CPUs

CPU 1513pro-2 PN

Overview



- CPU 1513pro-2 PN for SIMATIC ET 200pro based on S7-1500 CPU 1513-1 PN
- For applications with medium requirements on the program scope and processing speed, for distributed setup via PROFINET IO.
- PROFINET IO controller for operating distributed I/O on PROFINET
- PROFINET I-Device for connecting the CPU as an intelligent PROFINET device with a SIMATIC or non-Siemens PROFINET IO controller
- PROFINET shared I-Device for 4 controllers
- PROFINET IO RT/IRT interface with integrated 3-port switch
- Additional PROFINET IO RT interface with separate IP address
- Isochronous mode on PROFINET
- Integrated Motion Control functionalities for controlling speed-controlled and positioning axes, support for external encoders, output cams/cam tracks and probes
- OPC UA server and client (data access) as runtime option for the easy connection of SIMATIC ET 200pro to non-Siemens devices/systems
- Integrated web server with the option of creating user-defined web pages

Note

SIMATIC Memory Card required for operation of the CPU.

Technical specifications

Article number	6ES7513-2PL00-0AB0 ET 200pro: CPU 1513pro-2 PN
General information	
Product type designation	CPU 1513pro-2 PN
Product function	
• Isochronous mode	Yes; Via X1, with minimum OB 6x cycle of 500 µs
Engineering with	
• STEP 7 TIA Portal configurable/integrated as of version	V16
Supply voltage	
Type of supply voltage	24 V DC
Memory	
Work memory	
• integrated (for program)	300 kbyte
• integrated (for data)	1.5 Mbyte
Load memory	
• Plug-in (SIMATIC Memory Card), max.	32 Gbyte
CPU processing times	
for bit operations, typ.	40 ns
for word operations, typ.	48 ns
for fixed point arithmetic, typ.	64 ns
for floating point arithmetic, typ.	256 ns
Counters, timers and their retentivity	
S7 counter	
• Number	2 048
IEC counter	
• Number	Any (only limited by the main memory)

Article number	6ES7513-2PL00-0AB0 ET 200pro: CPU 1513pro-2 PN
S7 times	
• Number	2 048
IEC timer	
• Number	Any (only limited by the main memory)
Data areas and their retentivity	
Flag	
• Number, max.	16 kbyte
Address area	
I/O address area	
• Inputs	32 kbyte; All inputs are in the process image
• Outputs	32 kbyte; All outputs are in the process image
Time of day	
Clock	
• Type	Hardware clock
1. Interface	
Interface types	
• Number of ports	3; 2x M12 + 1x RJ45
• integrated switch	Yes
• RJ 45 (Ethernet)	Yes; X1 P3

Technical specifications

Article number	6ES7513-2PL00-0AB0 ET 200pro: CPU 1513pro-2 PN
Protocols	
• IP protocol	Yes; IPv4
• PROFINET IO Controller	Yes
• PROFINET IO Device	Yes
• SIMATIC communication	Yes
• Open IE communication	Yes; Optionally also encrypted
• Web server	Yes
• Media redundancy	Yes; MRP Automanager according to IEC 62439-2 Edition 2.0
PROFINET IO Controller	
Services	
- PG/OP communication	Yes
- S7 routing	Yes
- Isochronous mode	Yes
- Direct data exchange	Yes; Requirement: IRT and isochronous mode (MRPD optional)
- IRT	Yes
- MRP	Yes; as MRP redundancy manager and/or MRP client; max. number of devices in the ring: 50
- MRPD	Yes; Requirement: IRT
- PROFlenergy	Yes
- Prioritized startup	Yes; Max. 32 PROFINET devices
- Number of connectable IO Devices, max.	128; In total, up to 512 distributed I/O devices can be connected via AS-i, PROFIBUS or PROFINET
- Of which IO devices with IRT, max.	64
- Number of connectable IO Devices for RT, max.	128
- of which in line, max.	128
- Number of IO Devices that can be simultaneously activated/deactivated, max.	8; in total across all interfaces
- Number of IO Devices per tool, max.	8
- Updating times	The minimum value of the update time also depends on communication share set for PROFINET IO, on the number of IO devices, and on the quantity of configured user data
PROFINET IO Device	
Services	
- PG/OP communication	Yes
- S7 routing	Yes
- Isochronous mode	No
- IRT	Yes
- MRP	Yes; as MRP redundancy manager and/or MRP client; max. number of devices in the ring: 50
- MRPD	Yes; Requirement: IRT
- PROFlenergy	Yes; per user program
- Prioritized startup	No
- Shared device	Yes
- Number of IO Controllers with shared device, max.	4
- Asset management record	Yes; per user program

Article number	6ES7513-2PL00-0AB0 ET 200pro: CPU 1513pro-2 PN
2. Interface	
Interface types	
• Number of ports	1; 1x M12
• integrated switch	No
• RJ 45 (Ethernet)	No
Protocols	
• IP protocol	Yes; IPv4
• PROFINET IO Controller	Yes
• PROFINET IO Device	Yes
• SIMATIC communication	Yes
• Open IE communication	Yes; Optionally also encrypted
• Web server	Yes
• Media redundancy	No
PROFINET IO Controller	
Services	
- PG/OP communication	Yes
- S7 routing	Yes
- Isochronous mode	No
- Direct data exchange	No
- IRT	No
- MRP	No
- MRPD	No
- PROFlenergy	Yes
- Prioritized startup	No
- Number of connectable IO Devices, max.	32; In total, up to 512 distributed I/O devices can be connected via AS-i, PROFIBUS or PROFINET
- Number of connectable IO Devices for RT, max.	32
- of which in line, max.	32
- Number of IO Devices that can be simultaneously activated/deactivated, max.	8; in total across all interfaces
- Number of IO Devices per tool, max.	8
- Updating times	The minimum value of the update time also depends on communication share set for PROFINET IO, on the number of IO devices, and on the quantity of configured user data
PROFINET IO Device	
Services	
- PG/OP communication	Yes
- S7 routing	Yes
- Isochronous mode	No
- IRT	No
- MRP	No
- MRPD	No
- PROFlenergy	Yes; per user program
- Prioritized startup	No
- Shared device	Yes
- Number of IO Controllers with shared device, max.	4
- Asset management record	Yes; per user program

Distributed Controllers

based on ET 200Pro

Standard CPUs

CPU 1513pro-2 PN

Technical specifications

Article number	6ES7513-2PL00-0AB0 ET 200pro: CPU 1513pro-2 PN
Protocols	
Number of connections	
• Number of connections, max.	128; Via integrated interfaces of the CPU
OPC UA	
• OPC UA client	Yes; Data access (read, write), method call, custom address space
• OPC UA server	Yes; Data access (read, write, subscribe), method call, custom address space; embedded 2017 UA server profile V1.02
Supported technology objects	
Motion Control	Yes; Note: The number of axes affects the cycle time of the PLC program; selection guide via the TIA Selection Tool or SIZER
• Number of available Motion Control resources for technology objects	800
• Required Motion Control resources	
- per speed-controlled axis	40
- per positioning axis	80
- per synchronous axis	160
- per external encoder	80
- per output cam	20
- per cam track	160
- per probe	40
Controller	
• PID_Compact	Yes; Universal PID controller with integrated optimization
• PID_3Step	Yes; PID controller with integrated optimization for valves
• PID-Temp	Yes; PID controller with integrated optimization for temperature
Counting and measuring	
• High-speed counter	Yes

Article number	6ES7513-2PL00-0AB0 ET 200pro: CPU 1513pro-2 PN
Ambient conditions	
Ambient temperature during operation	
• horizontal installation, min.	-25 °C
• horizontal installation, max.	55 °C
• vertical installation, min.	-25 °C
• vertical installation, max.	55 °C
Altitude during operation relating to sea level	
• Installation altitude above sea level, max.	5 000 m; Restrictions for installation altitudes > 2 000 m, see manual
Configuration	
Programming	
Programming language	
- LAD	Yes
- FBD	Yes
- STL	Yes
- SCL	Yes
- GRAPH	Yes
Know-how protection	
• User program protection/password protection	Yes
• Copy protection	Yes
• Block protection	Yes
Access protection	
• Protection level: Write protection	Yes
• Protection level: Read/write protection	Yes
• Protection level: Complete protection	Yes
Dimensions	
Width	135 mm
Height	130 mm
Depth	65 mm
Weights	
Weight, approx.	614 g

7

Ordering data	Article No.	Article No.
CPU 1513pro-2 PN 300 KB work memory for program, 1.5 MB for data, PROFINET IO IRT interface, PROFINET IO RT interface, SIMATIC Memory Card required	6ES7513-2PL00-0AB0	
Accessories		
SIMATIC Memory Card 4 MB ¹⁾ 12 MB ¹⁾ 24 MB ¹⁾ 256 MB ¹⁾ 2 GB ¹⁾ 32 GB ¹⁾	6ES7954-8LC03-0AA0 6ES7954-8LE03-0AA0 6ES7954-8LF03-0AA0 6ES7954-8LL03-0AA0 6ES7954-8LP02-0AA0 6ES7954-8LT03-0AA0	
Terminal module CM CPU 2PN M12 / 7/8"; With 3 x M12 and 2 x 7/8", for connecting 2 x PROFINET	6ES7194-4AP00-0AA0	
Industrial Ethernet FC RJ45 plug 180 RJ45 plug connector for Industrial Ethernet with a rugged metal enclosure and integrated insulation displacement contacts for connecting Industrial Ethernet FC installation cables; with 180° cable outlet <ul style="list-style-type: none"> • 1 unit • 10 units • 50 units 	6GK1901-1BB10-2AA0 6GK1901-1BB10-2AB0 6GK1901-1BB10-2AE0	
Industrial Ethernet FastConnect installation cables <ul style="list-style-type: none"> • FastConnect standard cable • FastConnect trailing cable • FastConnect marine cable 	6XV1840-2AH10 6XV1840-3AH10 6XV1840-4AH10	
Industrial Ethernet FastConnect installation cables <ul style="list-style-type: none"> • IE FC TP trailing cable GP 2 x 2; sold by the meter, max. delivery unit 1 000 m; minimum order quantity 20 m. • IE TP torsion cable GP 2 x 2; sold by the meter, max. delivery unit 1 000 m; minimum order quantity 20 m. 	6XV1870-2D 6XV1870-2F	
Industrial Ethernet FastConnect Stripping Tool	6GK1901-1GA00	
		IE connecting cable M12-180/M12-180 <ul style="list-style-type: none"> • Preassembled IE FC TP trailing cable GP 2 x 2 (PROFINET Type C) with two 4-pin M12 plugs (4-pin, D-coded), degree of protection IP65/IP67, in various lengths: <ul style="list-style-type: none"> • 0.3 m • 0.5 m • 1.0 m • 1.5 m • 2.0 m • 3.0 m • 5.0 m • 10 m • 15 m • PROFINET M12 trailing connecting cable, preassembled at both ends with angled M12 connectors (male contact insert), in various lengths: <ul style="list-style-type: none"> • 3.0 m • 5.0 m • 10 m • PROFINET M12 trailing connecting cable, preassembled at one end with angled M12 connector (male contact insert at one end, other end open), in various lengths: <ul style="list-style-type: none"> • 3.0 m • 5.0 m • 10 m
		6XV1870-8AE30 6XV1870-8AE50 6XV1870-8AH10 6XV1870-8AH15 6XV1870-8AH20 6XV1870-8AH30 6XV1870-8AH50 6XV1870-8AN10 6XV1870-8AN15
		3RK1902-2NB30 3RK1902-2NB50 3RK1902-2NC10
		3RK1902-2HB30 3RK1902-2HB50 3RK1902-2HC10
		IE FC M12 plug PRO PROFINET M12 plug connector, D-coded with fast connection system, axial cable outlet. <ul style="list-style-type: none"> • 1 unit • 8 units • PROFINET M12 plug connector, D-coded, angled.
		6GK1901-0DB20-6AA0 6GK1901-0DB20-6AA8 3RK1902-2DA00
		IE panel feedthrough Cabinet feedthrough for converting from the M12 connection system (D-coded, IP65/IP67) to the RJ45 connection system (IP20), 1 pack = 5 units.
		6GK1901-0DM20-2AA5

¹⁾ An MMC is essential for operating the CPU

Distributed Controllers

based on ET 200Pro

Standard CPUs

CPU 1513pro-2 PN

Ordering data

Article No.

7/8" connecting cable to power supply

5-wire, 5 x 1.5 mm², trailing, preassembled with two 7/8" connectors (axial cable outlet), 5-pin, up to 50 m, in various lengths:

- 1.5 m
- 2.0 m
- 3.0 m
- 5.0 m
- 10 m
- 15 m
- Other special lengths with 90° or 180° cable outlet.

- Trailing power cable, 5 x 1.5 mm², preassembled at both ends with 7/8" angled connectors (female contact insert at one end, male contact insert at the other end), in various lengths:

- 3.0 m
- 5.0 m
- 10 m
- Trailing power cable, 5 x 1.5 mm², preassembled at one end with 7/8" angled connector with female contact insert (female contact insert at one end, other end open), in various lengths:

- 3.0 m
- 5.0 m
- 10 m

Power line

5-wire, 5 x 1.5 mm², trailing type, sold by the meter, minimum order quantity 20 m, maximum order quantity 1 000 m.

6XV1822-5BH15
6XV1822-5BH20
6XV1822-5BH30
6XV1822-5BH50
6XV1822-5BN10
6XV1822-5BN15

See

<http://support.automation.siemens.com/WWW/view/en/26999294>

3RK1902-3NB30
3RK1902-3NB50
3RK1902-3NC10

3RK1902-3GB30
3RK1902-3GB50
3RK1902-3GC10

6XV1830-8AH10

Article No.

7/8" connection plug

For ET 200eco, with axial cable outlet

- With male contact insert, 5-pack
- With female contact insert, 5-pack
- Angled, with female contact insert, 1 unit
- Angled, with male contact insert, 1 unit

7/8" cover cap, 10 per pack

6GK1905-0FA00
6GK1905-0FB00
3RK1902-3DA00

3RK1902-3BA00

6ES7194-3JA00-0AA0

Twisted Pair cables 4x2 with RJ45 connectors

0.5 m
1 m
2 m
6 m
10 m

6XV1870-3QE50
6XV1870-3QH10
6XV1870-3QH20
6XV1870-3QH60
6XV1870-3QN10

Crossed Twisted Pair cables 4x2 with RJ45 connectors

0.5 m
1 m
2 m
6 m
10 m

6XV1870-3RE50
6XV1870-3RH10
6XV1870-3RH20
6XV1870-3RH60
6XV1870-3RN10

M12 sealing cap

For protection of unused M12 connections with ET 200pro

3RX9802-0AA00

M12 sealing caps with female thread

5 units

6ES7194-4JD60-0AA0

Overview

- Fail-safe CPU 1513pro F-2 PN for SIMATIC ET 200pro based on S7-1500 CPU 1513F-1 PN
- For applications with medium requirements on the program scope and processing speed, for distributed setup via PROFINET IO.
- Can be used for safety functions up to SIL 3 according to IEC 61508 and up to PLe according to ISO 13849

- PROFINET IO controller for operating distributed I/O on PROFINET
- PROFINET I-Device for connecting the CPU as an intelligent PROFINET device with a SIMATIC or non-Siemens PROFINET IO controller
- PROFIsafe in centralized and distributed configurations
- PROFINET shared I-Device for 4 controllers
- PROFINET IO RT/IRT interface with integrated 3-port switch
- Additional PROFINET IO RT interface with separate IP address
- Isochronous mode on PROFINET
- Integrated Motion Control functionalities for controlling speed-controlled and positioning axes, support for external encoders
- OPC UA server and client (data access) as runtime option for the easy connection of SIMATIC ET 200pro to non-Siemens devices/systems
- Integrated web server with the option of creating user-defined web pages

Note

SIMATIC Memory Card required for operation of the CPU.

7

Technical specifications

Article number	6ES7513-2GL00-0AB0
	ET 200pro: CPU 1513pro F-2 PN
General information	
Product type designation	CPU 1513pro F-2 PN
Product function	
• Isochronous mode	Yes; Via X1, with minimum OB 6x cycle of 500 µs
Engineering with	
• STEP 7 TIA Portal configurable/integrated as of version	V16
Supply voltage	
Type of supply voltage	24 V DC
Memory	
Work memory	
• integrated (for program)	450 kbyte
• integrated (for data)	1.5 Mbyte
Load memory	
• Plug-in (SIMATIC Memory Card), max.	32 Gbyte
CPU processing times	
for bit operations, typ.	40 ns
for word operations, typ.	48 ns
for fixed point arithmetic, typ.	64 ns
for floating point arithmetic, typ.	256 ns
Counters, timers and their retentivity	
S7 counter	
• Number	2 048
IEC counter	
• Number	Any (only limited by the main memory)

Article number	6ES7513-2GL00-0AB0
	ET 200pro: CPU 1513pro F-2 PN
S7 times	
• Number	2 048
IEC timer	
• Number	Any (only limited by the main memory)
Data areas and their retentivity	
Flag	
• Number, max.	16 kbyte
Address area	
I/O address area	
• Inputs	32 kbyte; All inputs are in the process image
• Outputs	32 kbyte; All outputs are in the process image
1. Interface	
Interface types	
• Number of ports	3; 2x M12 + 1x RJ45
• integrated switch	Yes
• RJ 45 (Ethernet)	Yes; X1 P3
Protocols	
• IP protocol	Yes; IPv4
• PROFINET IO Controller	Yes
• PROFINET IO Device	Yes
• SIMATIC communication	Yes
• Open IE communication	Yes; Optionally also encrypted
• Web server	Yes
• Media redundancy	Yes; MRP Automanager according to IEC 62439-2 Edition 2.0

Distributed Controllers

based on ET 200Pro

Fail-safe CPUs

CPU 1513pro F-2 PN

Technical specifications

Article number	6ES7513-2GL00-0AB0 ET 200pro: CPU 1513pro F-2 PN
PROFINET IO Controller	
Services	
- PG/OP communication	Yes
- S7 routing	Yes
- Isochronous mode	Yes
- Direct data exchange	Yes; Requirement: IRT and isochronous mode (MRPD optional)
- Open IE communication	Yes
- IRT	Yes
- MRP	Yes; as MRP redundancy manager and/or MRP client; max. number of devices in the ring: 50
- MRPD	Yes; Requirement: IRT
- PROFinergy	Yes
- Prioritized startup	Yes; Max. 32 PROFINET devices
- Number of connectable IO Devices, max.	128; In total, up to 512 distributed I/O devices can be connected via AS-i, PROFIBUS or PROFINET
- Of which IO devices with IRT, max.	64
- Number of connectable IO Devices for RT, max.	128
- of which in line, max.	128
- Number of IO Devices that can be simultaneously activated/deactivated, max.	8; in total across all interfaces
- Number of IO Devices per tool, max.	8
- Updating times	The minimum value of the update time also depends on communication share set for PROFINET IO, on the number of IO devices, and on the quantity of configured user data
PROFINET IO Device	
Services	
- PG/OP communication	Yes
- S7 routing	Yes
- Isochronous mode	No
- Open IE communication	Yes
- IRT	Yes
- MRP	Yes; as MRP redundancy manager and/or MRP client; max. number of devices in the ring: 50
- MRPD	Yes; Requirement: IRT
- PROFinergy	Yes; per user program
- Prioritized startup	No
- Shared device	Yes
- Number of IO Controllers with shared device, max.	4
- Asset management record	Yes; per user program
2. Interface	
Interface types	
• Number of ports	1; 1x M12
• integrated switch	No
• RJ 45 (Ethernet)	No

Article number	6ES7513-2GL00-0AB0 ET 200pro: CPU 1513pro F-2 PN
Protocols	
• IP protocol	Yes; IPv4
• PROFINET IO Controller	Yes
• PROFINET IO Device	Yes
• SIMATIC communication	Yes
• Open IE communication	Yes; Optionally also encrypted
• Web server	Yes
• Media redundancy	No
PROFINET IO Controller	
Services	
- PG/OP communication	Yes
- S7 routing	Yes
- Isochronous mode	No
- Direct data exchange	No
- IRT	No
- MRP	No
- MRPD	No
- PROFinergy	Yes
- Prioritized startup	No
- Number of connectable IO Devices, max.	32; In total, up to 512 distributed I/O devices can be connected via AS-i, PROFIBUS or PROFINET
- Number of connectable IO Devices for RT, max.	32
- of which in line, max.	32
- Number of IO Devices that can be simultaneously activated/deactivated, max.	8; in total across all interfaces
- Number of IO Devices per tool, max.	8
- Updating times	The minimum value of the update time also depends on communication share set for PROFINET IO, on the number of IO devices, and on the quantity of configured user data
PROFINET IO Device	
Services	
- PG/OP communication	Yes
- S7 routing	Yes
- Isochronous mode	No
- Open IE communication	Yes
- IRT	No
- MRP	No
- MRPD	No
- PROFinergy	Yes; per user program
- Prioritized startup	No
- Shared device	Yes
- Number of IO Controllers with shared device, max.	4
- Asset management record	Yes; per user program

Technical specifications

Article number	6ES7513-2GL00-0AB0 ET 200pro: CPU 1513pro F-2 PN
Protocols	
Number of connections	
• Number of connections, max.	128; Via integrated interfaces of the CPU
PROFINET IO Controller	
Services	
- Number of connectable IO Devices, max.	256
- Of which IO devices with IRT, max.	64
- Number of connectable IO Devices for RT, max.	256
OPC UA	
• OPC UA client	Yes
• OPC UA server	Yes; Data access (read, write, subscribe), method call, custom address space
Supported technology objects	
Motion Control	Yes; Note: The number of axes affects the cycle time of the PLC program; selection guide via the TIA Selection Tool or SIZER
• Number of available Motion Control resources for technology objects	800
• Required Motion Control resources	
- per speed-controlled axis	40
- per positioning axis	80
- per synchronous axis	160
- per external encoder	80
- per output cam	20
- per cam track	160
- per probe	40
Controller	
• PID_Compact	Yes; Universal PID controller with integrated optimization
• PID_3Step	Yes; PID controller with integrated optimization for valves
• PID-Temp	Yes; PID controller with integrated optimization for temperature
Counting and measuring	
• High-speed counter	Yes

Article number	6ES7513-2GL00-0AB0 ET 200pro: CPU 1513pro F-2 PN
Standards, approvals, certificates	
Highest safety class achievable in safety mode	
Probability of failure (for service life of 20 years and repair time of 100 hours)	
- Low demand mode: PFDavg in accordance with SIL3	< 2.00E-05
- High demand/continuous mode: PFH in accordance with SIL3	< 1.00E-09
Ambient conditions	
Ambient temperature during operation	
• horizontal installation, min.	-25 °C
• horizontal installation, max.	55 °C
• vertical installation, min.	-25 °C
• vertical installation, max.	55 °C
Altitude during operation relating to sea level	
• Installation altitude above sea level, max.	5 000 m; Restrictions for installation altitudes > 2 000 m, see manual
Configuration	
Programming	
Programming language	
- LAD	Yes; incl. failsafe
- FBD	Yes; incl. failsafe
- STL	Yes
- SCL	Yes
- GRAPH	Yes
Know-how protection	
• User program protection/password protection	Yes
• Copy protection	Yes
• Block protection	Yes
Access protection	
• Protection level: Write protection	Yes
• Protection level: Read/write protection	Yes
• Protection level: Complete protection	Yes
Dimensions	
Width	135 mm
Height	130 mm
Depth	65 mm
Weights	
Weight, approx.	614 g

Distributed Controllers

based on ET 200Pro

Fail-safe CPUs

CPU 1513pro F-2 PN

Ordering data	Article No.	Article No.
CPU 1513pro F-2 PN 450 KB work memory for program, 1.5 MB for data, PROFINET IO IRT interface, PROFINET IO RT interface, SIMATIC Memory Card required	6ES7513-2GL00-0AB0	
Accessories		
SIMATIC Memory Card 4 MB ¹⁾ 12 MB ¹⁾ 24 MB ¹⁾ 256 MB ¹⁾ 2 GB ¹⁾ 32 GB ¹⁾	6ES7954-8LC03-0AA0 6ES7954-8LE03-0AA0 6ES7954-8LF03-0AA0 6ES7954-8LL03-0AA0 6ES7954-8LP02-0AA0 6ES7954-8LT03-0AA0	
Terminal module CM CPU 2PN M12 / 7/8"; With 3 x M12 and 2 x 7/8", for connecting 2 x PROFINET	6ES7194-4AP00-0AA0	
Industrial Ethernet FC RJ45 plug 180 RJ45 plug connector for Industrial Ethernet with a rugged metal enclosure and integrated insulation displacement contacts for connecting Industrial Ethernet FC installation cables; with 180° cable outlet <ul style="list-style-type: none"> • 1 unit • 10 units • 50 units 	6GK1901-1BB10-2AA0 6GK1901-1BB10-2AB0 6GK1901-1BB10-2AE0	
Industrial Ethernet FastConnect installation cables <ul style="list-style-type: none"> • FastConnect standard cable • FastConnect trailing cable • FastConnect marine cable 	6XV1840-2AH10 6XV1840-3AH10 6XV1840-4AH10	
Industrial Ethernet FastConnect installation cables <ul style="list-style-type: none"> • IE FC TP trailing cable GP 2 x 2; sold by the meter, max. delivery unit 1 000 m; minimum order quantity 20 m. • IE TP torsion cable GP 2 x 2; sold by the meter, max. delivery unit 1 000 m; minimum order quantity 20 m. 	6XV1870-2D 6XV1870-2F	
Industrial Ethernet FastConnect Stripping Tool	6GK1901-1GA00	
		IE connecting cable M12-180/M12-180 Preassembled IE FC TP trailing cable GP 2 x 2 (PROFINET Type C) with two 4-pin M12 plugs (4-pin, D-coded), degree of protection IP65/IP67, in various lengths: <ul style="list-style-type: none"> • 0.3 m • 0.5 m • 1.0 m • 1.5 m • 2.0 m • 3.0 m • 5.0 m • 10 m • 15 m PROFINET M12 trailing connecting cable, preassembled at both ends with angled M12 connectors (male contact insert), in various lengths: <ul style="list-style-type: none"> • 3.0 m • 5.0 m • 10 m PROFINET M12 trailing connecting cable, preassembled at one end with angled M12 connector (male contact insert at one end, other end open), in various lengths: <ul style="list-style-type: none"> • 3.0 m • 5.0 m • 10 m
		6XV1870-8AE30 6XV1870-8AE50 6XV1870-8AH10 6XV1870-8AH15 6XV1870-8AH20 6XV1870-8AH30 6XV1870-8AH50 6XV1870-8AN10 6XV1870-8AN15
		3RK1902-2NB30 3RK1902-2NB50 3RK1902-2NC10
		3RK1902-2HB30 3RK1902-2HB50 3RK1902-2HC10
		IE FC M12 plug PRO PROFINET M12 plug connector, D-coded with fast connection system, axial cable outlet. <ul style="list-style-type: none"> • 1 unit • 8 units • PROFINET M12 plug connector, D-coded, angled.
		6GK1901-0DB20-6AA0 6GK1901-0DB20-6AA8 3RK1902-2DA00
		IE panel feedthrough Cabinet feedthrough for converting from the M12 connection system (D-coded, IP65/IP67) to the RJ45 connection system (IP20), 1 pack = 5 units.
		6GK1901-0DM20-2AA5

¹⁾ An MMC is essential for operating the CPU

Ordering data	Article No.	Ordering data	Article No.
7/8" connecting cable to power supply 5-wire, 5 x 1.5 mm ² , trailing, preassembled with two 7/8" connectors (axial cable outlet), 5-pin, up to 50 m, in various lengths: <ul style="list-style-type: none"> • 1.5 m • 2.0 m • 3.0 m • 5.0 m • 10 m • 15 m • Other special lengths with 90° or 180° cable outlet. 	6XV1822-5BH15 6XV1822-5BH20 6XV1822-5BH30 6XV1822-5BH50 6XV1822-5BN10 6XV1822-5BN15 See: http://support.automation.siemens.com/WW/view/en/26999294	7/8" connection plug For ET 200eco, with axial cable outlet <ul style="list-style-type: none"> • With male contact insert, 5-pack • With female contact insert, 5-pack • Angled, with female contact insert, 1 unit • Angled, with male contact insert, 1 unit 	6GK1905-0FA00 6GK1905-0FB00 3RK1902-3DA00 3RK1902-3BA00
Trailing power cable, 5 x 1.5 mm ² , preassembled at both ends with 7/8" angled connectors (female contact insert at one end, male contact insert at the other end), in various lengths: <ul style="list-style-type: none"> • 3.0 m • 5.0 m • 10 m 	3RK1902-3NB30 3RK1902-3NB50 3RK1902-3NC10	7/8" cover cap, 10 per pack	6ES7194-3JA00-0AA0
Trailing power cable, 5 x 1.5 mm ² , preassembled at one end with 7/8" angled connector with female contact insert (female contact insert at one end, other end open), in various lengths: <ul style="list-style-type: none"> • 3.0 m • 5.0 m • 10 m 	3RK1902-3GB30 3RK1902-3GB50 3RK1902-3GC10	Twisted Pair cables 4x2 with RJ45 connectors 0.5 m 1 m 2 m 6 m 10 m	6XV1870-3QE50 6XV1870-3QH10 6XV1870-3QH20 6XV1870-3QH60 6XV1870-3QN10
Power line 5-wire, 5 x 1.5 mm ² , trailing type, sold by the meter, minimum order quantity 20 m, maximum order quantity 1 000 m.	6XV1830-8AH10	Crossed Twisted Pair cables 4x2 with RJ45 connectors 0.5 m 1 m 2 m 6 m 10 m	6XV1870-3RE50 6XV1870-3RH10 6XV1870-3RH20 6XV1870-3RH60 6XV1870-3RN10
		M12 sealing cap For protection of unused M12 connections with ET 200pro	3RX9802-0AA00
		M12 sealing caps with female thread 5 units	6ES7194-4JD60-0AA0

Distributed Controllers

Notes

7



8/2

SIMATIC S7-1500 Software Controllers

8/2

Add-on applications

8/2

ODK 1500S serial driver

Software Controllers

SIMATIC S7-1500 Software Controllers

Add-on applications

ODK 1500S serial driver

Overview

Note

This catalog entry contains non-binding information about supplementary application software for the SIMATIC S7-1500 Software Controller and the SIMATIC ET 200SP Open Controller.

Overview

The ODK 1500S serial driver enables serial communication from the STEP 7 user program via the integrated serial interface of a SIMATIC IPC or, depending on the application environment, via a USB-to-serial adapter. All serial interfaces of the PC are supported, which are addressed in Windows as COM n interface, e.g. RS232, RS422 or RS485.

Application

Function blocks (FBs) such as ODK1500S_Serial_P_SEND for sending data and ODK1500S_Serial_P_RCV for receiving data are available to the user. The FBs are interface-compatible with the CP340-RS232-C and support ASCII communication.

The use of a USB-to-serial adapter or of the integrated serial interface of an IPC is a cost-effective solution for connecting IO devices such as scanners, scales, and temperature loggers to an S7-1500 Software Controller using a serial interface.

More information

If you are interested, please contact your sales representative:
<http://www.automation.siemens.com/partner/>

You can find Service and Support at:
<https://support.industry.siemens.com/cs/ww/en/view/109479259>

Drive Controllers



9/2

Introduction

9/3

Technology CPUs

9/3

CPU 1504D TF

9/9

CPU 1507D TF

Drive Controllers

Introduction

Drive Controllers

Overview



The SIMATIC Drive Controller sets standards in terms of a perfect integration of SIMATIC S7-1500 controller and SINAMICS S120 drive system. It integrates Motion Control, technology and PLC functionalities directly into the modular SINAMICS S120 multi-axis drive system – and that without requiring additional space in the control cabinet for the control system. In addition, the assembly and wiring effort is reduced and the data management for the control system and integrated drive control takes place centrally on a SIMATIC Memory Card.

The SIMATIC Drive Controller is available in two performance classes and both fail-safe technology CPUs (CPU 1504D TF and CPU 1507D TF) meet even the most demanding Motion Control needs.

The fail-safe CPUs permit the processing of standard and safety programs on the same controller.

As technology CPUs, they also have extensive Motion Control functions such as:

- Speed and positioning axes
- Synchronous operation functions
 - Synchronizing with/without specifying the synchronization position
 - Actual value coupling
 - Shifting of the master value at following axis
 - Camming
 - Cross-PLC synchronous operation
- Cam
- Cyclic specification of the motion vector from the application (MotionIn interface)
- Kinematics
 - With up to 4 interpolating axes (e.g. cartesian portal, delta picker, roller picker, articulated arm, cylindrical robot, tripod picker and SCARA)
 - User-defined kinematics
- External encoders, output cams and measuring inputs

The extensive integrated interfaces and technology I/Os are consistently available in all performance classes and enable the efficient implementation of compact and modular automation solutions with Motion Control based on the SINAMICS S120 drive system.

Thanks to fast system response times, the SIMATIC Drive Controller is the ideal solution wherever axes with high configuration limits and the shortest cycle times for high machine cycle rates and optimum product quality through deterministic and reproducible machine behavior are required.

The SIMATIC Drive Controller is configured in the TIA Portal V16 or higher with the SIMATIC STEP 7 Professional engineering software and SINAMICS Startdrive.

The SIMATIC Drive Controller can be extended with components from the modular SINAMICS S120 drive system and SIMATIC automation components such as HMI and I/O systems. Additional drive systems such as e.g. SINAMICS S210 or SINAMICS G can easily be integrated via PROFINET.

Videos

- [SIMATIC Drive Controller video](#)

Overview



CPU 1504D TF

- For standard and fail-safe applications with medium requirements for program scope and processing speed
- Ultra-compact due to the integration of fail-safe SIMATIC S7-1500 technology CPU, SINAMICS S120 drive control and technology I/Os in a single device
- Extensive integrated communication interfaces and technology I/Os for the efficient implementation of automation solutions with Motion Control
- Proven engineering in the TIA Portal

Technical specifications

Article number	6ES7615-4DF10-0AB0 SIMATIC Drive Controller, CPU 1504D TF
General information	
Product type designation	CPU 1504D TF
Engineering with	
• STEP 7 TIA Portal configurable/ integrated as of version	V16
Integrated drive control	
• Number of axes for servo control, max.	6
• Number of axes for vector control, max.	6
• Number of axes for V/f control, max.	12
• Remark	Alternative control modes; drive control based on SINAMICS S120 CU320-2 (firmware version V5.x); functional subset compared to CU320-2: no DCC/DCB, EPOS, free function blocks, etc.); see manual for details
Supply voltage	
Type of supply voltage	24 V DC
Memory	
Work memory	
• integrated (for program)	2 Mbyte
• integrated (for data)	4 Mbyte
Load memory	
• Plug-in (SIMATIC Memory Card), required	12 Mbyte; Recommended at least when integrated drive is used
• Plug-in (SIMATIC Memory Card), max.	32 Gbyte
Counters, timers and their retentivity	
S7 counter	
• Number	2 048
IEC counter	
• Number	Any (only limited by the main memory)

Article number	6ES7615-4DF10-0AB0 SIMATIC Drive Controller, CPU 1504D TF
S7 times	
• Number	2 048
IEC timer	
• Number	Any (only limited by the main memory)
Data areas and their retentivity	
Flag	
• Number, max.	16 kbyte
Address area	
I/O address area	
• Inputs	32 kbyte; All inputs are in the process image
• Outputs	32 kbyte; All outputs are in the process image
Time of day	
Clock	
• Type	Hardware clock
Digital inputs	
integrated channels (DI)	28; max. depending on parameterization
Digital outputs	
integrated channels (DO)	16; max. depending on parameterization
Digital outputs, parameterizable	Yes; 8 DI/DQ (X122/X132, SINAMICS Integrated) + 8 DI/DQ (X142, PLC)
Short-circuit protection	Yes; electronic/thermal
1. Interface	
Interface types	
• Number of ports	3
• integrated switch	Yes
• RJ 45 (Ethernet)	Yes; X150

Drive Controllers

Technology CPUs

CPU 1504D TF

Technical specifications

Article number	6ES7615-4DF10-0AB0 SIMATIC Drive Controller, CPU 1504D TF
Protocols	
• IP protocol	Yes; IPv4
• PROFINET IO Controller	Yes
• PROFINET IO Device	Yes
• SIMATIC communication	Yes
• Open IE communication	Yes; Optionally also encrypted
• Web server	Yes
• Media redundancy	Yes; MRP Automanager according to IEC 62439-2 Edition 2.0
PROFINET IO Controller	
Services	
- PG/OP communication	Yes
- S7 routing	Yes
- Isochronous mode	Yes
- Direct data exchange	Yes; Requirement: IRT and isochronous mode (MRPD optional)
- shortest clock pulse	500 µs
- Open IE communication	Yes
- IRT	Yes
- MRP	Yes; MRP Automanager acc. to IEC 62439-2 Edition 2.0; MRP Manager; MRP Client; max. number of devices in the ring: 50
- MRPD	Yes; Requirement: IRT
- PROFINergy	Yes
- Prioritized startup	Yes; Max. 32 PROFINET devices
- Number of connectable IO Devices, max.	256; In total, up to 1 000 distributed I/O devices can be connected via AS-i, PROFIBUS or PROFINET
- Of which IO devices with IRT, max.	64
- Number of connectable IO Devices for RT, max.	256
- of which in line, max.	256
- Number of IO Devices that can be simultaneously activated/deactivated, max.	8; in total across all interfaces
- Number of IO Devices per tool, max.	8
- Updating times	The minimum value of the update time also depends on communication share set for PROFINET IO, on the number of IO devices, and on the quantity of configured user data
Update time for IRT	
- for send cycle of 500 µs	500 µs to 8 ms
- for send cycle of 1 ms	1 ms to 16 ms
- for send cycle of 2 ms	2 ms to 32 ms
- for send cycle of 4 ms	4 ms to 64 ms
- With IRT and parameterization of "odd" send cycles	Update time = set "odd" send clock (any multiple of 125 µs: 375 µs, 625 µs ... 3 875 µs)
Update time for RT	
- for send cycle of 500 µs	500 µs to 256 ms
- for send cycle of 1 ms	1 ms to 512 ms
- for send cycle of 2 ms	2 ms to 512 ms
- for send cycle of 4 ms	4 ms to 512 ms

Article number	6ES7615-4DF10-0AB0 SIMATIC Drive Controller, CPU 1504D TF
PROFINET IO Device	
Services	
- PG/OP communication	Yes
- S7 routing	Yes
- Isochronous mode	No
- shortest clock pulse	500 µs
- Open IE communication	Yes
- IRT	Yes
- MRP	Yes; MRP Automanager acc. to IEC 62439-2 Edition 2.0; MRP Manager; MRP Client; max. number of devices in the ring: 50
- MRPD	Yes; Requirement: IRT
- PROFINergy	Yes; per user program
- Shared device	Yes
- Number of IO Controllers with shared device, max.	4
- Asset management record	Yes; per user program
2. Interface	
Interface types	
• Number of ports	1
• integrated switch	No
• RJ 45 (Ethernet)	Yes; X160
Protocols	
• IP protocol	Yes; IPv4
• PROFINET IO Controller	Yes
• PROFINET IO Device	Yes
• SIMATIC communication	Yes
• Open IE communication	Yes; Optionally also encrypted
• Web server	Yes
• Media redundancy	No
PROFINET IO Controller	
Services	
- PG/OP communication	Yes
- S7 routing	Yes
- Isochronous mode	No
- Direct data exchange	No
- Open IE communication	Yes
- IRT	No
- MRP	No
- MRPD	No
- PROFINergy	Yes
- Prioritized startup	No
- Number of connectable IO Devices, max.	128; In total, up to 1 000 distributed I/O devices can be connected via AS-i, PROFIBUS or PROFINET
- Number of connectable IO Devices for RT, max.	128
- of which in line, max.	128
- Number of IO Devices that can be simultaneously activated/deactivated, max.	8; in total across all interfaces
- Number of IO Devices per tool, max.	8
- Updating times	The minimum value of the update time also depends on communication share set for PROFINET IO, on the number of IO devices, and on the quantity of configured user data

Technical specifications

Article number	6ES7615-4DF10-0AB0 SIMATIC Drive Controller, CPU 1504D TF
Update time for RT - for send cycle of 1 ms	1 ms to 512 ms
PROFINET IO Device	
Services	
- PG/OP communication	Yes
- S7 routing	Yes
- Isochronous mode	No
- Open IE communication	Yes
- IRT	No
- MRP	No
- MRPD	No
- PROFinergy	Yes; per user program
- Prioritized startup	No
- Shared device	Yes
- Number of IO Controllers with shared device, max.	4
- Asset management record	Yes; per user program
3. Interface	
Interface types	
• Number of ports	1
• integrated switch	No
• RJ 45 (Ethernet)	Yes; X130
Protocols	
• IP protocol	Yes; IPv4
• PROFINET IO Controller	No
• PROFINET IO Device	No
• SIMATIC communication	Yes
• Open IE communication	Yes
• Web server	Yes
4. Interface	
Interface types	
• Number of ports	1
• RS 485	Yes; X126
Protocols	
• PROFIBUS DP master	Yes
• PROFIBUS DP slave	No
• SIMATIC communication	Yes
Protocols	
Number of connections	
• Number of connections, max.	320; Via integrated interfaces of the CPU
PROFIBUS DP master	
Services	
- Number of DP slaves	125; In total, up to 1 000 distributed I/O devices can be connected via AS-i, PROFIBUS or PROFINET
OPC UA	
• OPC UA client	Yes
• OPC UA server	Yes; Data access (read, write, subscribe), method call, custom address space
Isochronous mode	
Isochronous operation (application synchronized up to terminal)	Yes; With minimum OB 6x cycle of 500 µs

Article number	6ES7615-4DF10-0AB0 SIMATIC Drive Controller, CPU 1504D TF
Supported technology objects	
Motion Control	Yes
• Number of available Motion Control resources for technology objects	2 400
• Required Motion Control resources	
- per speed-controlled axis	40
- per positioning axis	80
- per synchronous axis	160
- per external encoder	80
- per output cam	20
- per cam track	160
- per probe	40
• Number of available Extended Motion Control resources for technology objects	120
• Required Extended Motion Control resources	
- for each cam	2
- for each set of kinematics	30
- Per leading axis proxy	3
Controller	
• PID_Compact	Yes; Universal PID controller with integrated optimization
• PID_3Step	Yes; PID controller with integrated optimization for valves
• PID-Temp	Yes; PID controller with integrated optimization for temperature
Counting and measuring	
• High-speed counter	Yes
Standards, approvals, certificates	
Highest safety class achievable in safety mode	
Probability of failure (for service life of 20 years and repair time of 100 hours)	
- Low demand mode: PFDavg in accordance with SIL2	< 14.00E-04
- Low demand mode: PFDavg in accordance with SIL3 (if exclusively F-CPU is used)	< 2.00E-05 PLd
- High demand/continuous mode: PFH in accordance with SIL2	< 14.00E-09
- High demand/continuous mode: PFH in accordance with SIL3 (if exclusively F-CPU is used)	< 1.00E-09
Ambient conditions	
Ambient temperature during operation	
• min.	0 °C
• max.	55 °C
Altitude during operation relating to sea level	
• Installation altitude above sea level, max.	4 000 m; Above an altitude of 2 000 m, the max. ambient temperature decreases by 7 °C every 1 000 m
• Ambient air temperature-barometric pressure-altitude	Permissible air pressure: 620 hPa ... 1 060 hPa

Drive Controllers

Technology CPUs

CPU 1504D TF

Technical specifications

Article number	6ES7615-4DF10-0AB0 SIMATIC Drive Controller, CPU 1504D TF
Configuration	
Programming	
Programming language	
- LAD	Yes; incl. failsafe
- FBD	Yes; incl. failsafe
- STL	Yes
- SCL	Yes
- GRAPH	Yes
Know-how protection	
• User program protection/password protection	Yes
• Copy protection	Yes
• Block protection	Yes

Article number	6ES7615-4DF10-0AB0 SIMATIC Drive Controller, CPU 1504D TF
Access protection	
• Protection level: Write protection	Yes
• Protection level: Read/write protection	Yes
• Protection level: Write protection for Failsafe	Yes
• Protection level: Complete protection	Yes
Dimensions	
Width	50 mm
Height	300 mm
Depth	226 mm; 270 mm with spacer (included in scope of supply)
Weights	
Weight, approx.	2 200 g
Other	
Note:	fanless operation

Ordering data

Article No.	Article No.
SIMATIC S7-1500 CPU 1504D TF drive controller With SINAMICS S120 Integrated; Fail-safe technology CPU; Work memory: 2 MB for program, 4 MB for data; Interfaces: 12 DI, 16 DI/DQ, 4 DRIVE-CLiQ, 3 PROFINET; 3+1+1 ports, 1 PROFIBUS; SIMATIC Memory Card required	6ES7615-4DF10-0AB0
Accessories	
SIMATIC Memory Card ¹⁾	
• 4 MB	6ES7954-8LC03-0AA0
• 12 MB	6ES7954-8LE03-0AA0
• 24 MB	6ES7954-8LF03-0AA0
• 256 MB	6ES7954-8LL03-0AA0
• 2 GB	6ES7954-8LP02-0AA0
• 32 GB	6ES7954-8LT03-0AA0
<i>Drive licenses for integrated drive control</i>	
Safety Integrated Extended Functions License certificate for a SINAMICS S120 axis	6SL3074-0AA10-0AA0
Safety Integrated Advanced Functions License certificate for a SINAMICS S120 axis Additional SINAMICS licenses (technology extension VIBX, ...) available soon.	6SL3074-0AA20-0AA0

Article No.

<i>Control licenses</i>	
SIMATIC OPC UA S7-1500 Small Required for CPU 1504D TF Single runtime license	
• License certificate for OPC UA server (data access and OPC UA client)	6ES7823-0BA00-1BA0
• Download incl. license certificate for OPC UA server (data access and OPC UA client) ³⁾ Email address required for delivery	6ES7823-0BE00-1BA0
<i>Accessories for PROFIBUS (interface X126)</i>	
PROFIBUS RS485 bus connection plug With angular cable outlet (35°) with screw-type terminals, max. transmission rate 12 Mbps	
• Without PG/PC interface	6ES7972-0BA42-0XA0
• With PG/PC interface	6ES7972-0BB42-0XA0

¹⁾ When using the integrated SINAMICS S120 drive control, a memory card size of at least 12 MB is recommended. A memory card size of at least 256 MB is required for firmware updates.

³⁾ For up-to-date information and download availability, see: <http://www.siemens.com/tia-online-software-delivery>

Ordering data	Article No.	Article No.
PROFIBUS FastConnect RS485 bus connection plug With angular cable outlet (35°) with insulation displacement technology, max. transmission rate 12 Mbps <ul style="list-style-type: none"> Without PG/PC interface With PG/PC interface 	6ES7972-0BA61-0XA0 6ES7972-0BB61-0XA0	<i>Other accessories</i>
FastConnect cables for PROFIBUS (sold by the meter; max. length 1 000 m; minimum order quantity 20 m) <ul style="list-style-type: none"> FC standard cable GP FC robust cable FC flexible cable FC trailing cable, sheath color: Petrol FC trailing cable, sheath color: Violet FC food cable FC ground cable FC FRNC cable GP 	6XV1830-0EH10 6XV1830-0JH10 6XV1831-2K 6XV1830-3EH10 6XV1831-2L 6XV1830-0GH10 6XV1830-3FH10 6XV1830-0LH10	PROFIBUS FastConnect Stripping Tool 6GK1905-6AA00 Pre-adjusted Stripping Tool for fast stripping of PROFIBUS FastConnect bus cables IE FC Stripping Tool 6GK1901-1GA00 Pre-adjusted Stripping Tool for fast stripping of Industrial Ethernet FC cables Dust protection blanking plugs 6SL3066-4CA00-0AA0 For sealing unused DRIVE-CLiQ and PROFINET ports; blanking plug (50 units)
<i>Accessories for PROFINET (interface X150 and X160; X130 only up to 100 Mbps)</i>		<i>PLC Engineering Software</i>
IE FC RJ45 plug 145 145° cable outlet (10/100 Mbps) <ul style="list-style-type: none"> 1 unit 10 units 50 units 	6GK1901-1BB30-0AA0 6GK1901-1BB30-0AB0 6GK1901-1BB30-0AE0	STEP 7 Professional V16 <i>Target system:</i> SIMATIC S7-1200, S7-1500, S7-300, S7-400, WinAC <i>Requirement:</i> Windows 7 Professional SP1 Windows 7 Enterprise SP1 Windows 7 Ultimate SP1 Windows 10 Professional Version 1809, 1903 Windows 10 Enterprise Version 1809, 1903 Windows 10 IoT Enterprise 2015 LTSB Windows 10 IoT Enterprise 2016 LTSB Windows 10 IoT Enterprise 2019 LTSC Windows Server 2012 R2 StdE (full installation) Windows Server 2016 Standard (full installation) Windows Server 2019 Standard (full installation) <i>Type of delivery:</i> German, English, Chinese, Italian, French, Spanish
FastConnect cables for Industrial Ethernet/PROFINET (sold by the meter; max. length 1 000 m; minimum order quantity 20 m) <ul style="list-style-type: none"> IE FC standard cable GP 2x2 IE FC flexible cable GP 2x2 IE FC trailing cable GP 2x2 IE FC trailing cable 2x2 IE FC marine cable 2x2 	6XV1840-2AH10 6XV1870-2B 6XV1870-2D 6XV1840-3AH10 6XV1840-4AH10	6ES7822-1AA06-0YA5 6ES7822-1AE06-0YA5
<i>Accessories for PROFINET²⁾ (interface X130, for up to 1 000 Mbps)</i>		STEP 7 Professional V16, floating license STEP 7 Professional V16, floating license, software download including license key ³⁾ Email address required for delivery
IE FC RJ45 plug 180 180° cable outlet (10/100/1 000 Mbps) <ul style="list-style-type: none"> 1 unit 10 units 50 units 	6GK1901-1BB11-2AA0 6GK1901-1BB11-2AB0 6GK1901-1BB11-2AE0	
FastConnect cables for Industrial Ethernet/PROFINET (sold by the meter; max. length 1 000 m; minimum order quantity 20 m) <ul style="list-style-type: none"> IE FC standard cable GP 4x2 IE FC flexible cable GP 4x2 	6XV1878-2A 6XV1878-2B	

²⁾ The Ethernet interface X130 supports 10, 100 and 1 000 Mbps. For 1 000 Mbps, 8-wire cables (4x2) and the 180° FastConnect connector in 1 000 Mbps version must be used.

³⁾ For up-to-date information and download availability, see: <http://www.siemens.com/tia-online-software-delivery>

Drive Controllers

Technology CPUs

CPU 1504D TF

Ordering data

STEP 7 Safety Advanced V16

Task:

Engineering tool for configuring and programming fail-safe user programs for SIMATIC S7-1200 FC, S7-1500F, S7-1500F Software Controller, S7-300F, S7-400F, WinAC RTX F, ET 200SP F Controller and the fail-safe ET 200SP, ET 200MP, ET 200S, ET 200M, ET 200iSP, ET 200pro and ET 200eco I/O

Requirement:

STEP 7 Professional V16

Note:

As from TIA Portal V16, the SIMATIC STEP 7 Safety software is an integral part of the SIMATIC STEP 7 product setup. The functionality of SIMATIC STEP 7 Safety is activated by means of the license key supplied in each case.

Floating license for 1 user;
license key on USB flash drive

6ES7833-1FA16-0YA5

Floating license for 1 user,
license key for download ³⁾;
email address required for delivery

6ES7833-1FA16-0YH5

Documentation

SIMATIC Manual Collection

6ES7998-8XC01-8YE0

Electronic manuals on DVD,
multilingual

SIMATIC Manual Collection Update service for 1 year

6ES7998-8XC01-8YE2

Current Manual Collection DVD and
the three subsequent updates

Article No.

*Engineering software
for SINAMICS drives*

SINAMICS Startdrive ⁴⁾ Basic V16

TIA Portal engineering and
commissioning tool for
SINAMICS drives

- DVD
- OSD / software download ³⁾
Email address required
for delivery

6SL3072-4GA02-0XA0
6SL3072-4GA02-0XG0

SINAMICS Startdrive Advanced V16

TIA Portal engineering and
commissioning tool for
SINAMICS drives;
Advanced version including
safety acceptance testing for the
SINAMICS G120, SINAMICS S120
and SINAMICS S210 converter
series

- DVD
- OSD / software download ³⁾
Email address required
for delivery

6SL3072-4GA02-0XA5
6SL3072-4GA02-0XG5

³⁾ For up-to-date information and download availability, see:
<http://www.siemens.com/tia-online-software-delivery>

⁴⁾ The SINAMICS Startdrive Basic commissioning tool is available for free on
the Internet at: <https://www.siemens.com/startdrive>

Overview

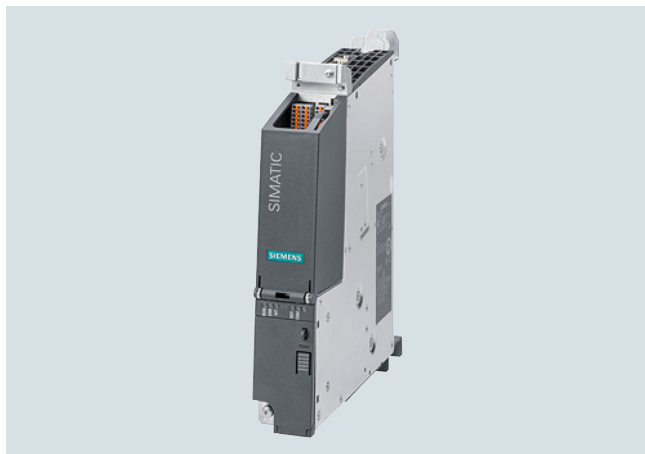

CPU 1507D TF

- For standard and fail-safe applications with high to very high requirements for program scope and processing speed
- Ultra-compact due to the integration of fail-safe SIMATIC S7-1500 technology CPU, SINAMICS S120 drive control and technology I/Os in a single device
- Extensive integrated communication interfaces and technology I/Os for the efficient implementation of automation solutions with Motion Control
- Proven engineering in the TIA Portal

Technical specifications

Article number	6ES7615-7DF10-0AB0 SIMATIC Drive Controller, CPU 1507D TF
General information	
Product type designation	CPU 1507D TF
Engineering with	
• STEP 7 TIA Portal configurable/ integrated as of version	V16
Integrated drive control	
• Number of axes for servo control, max.	6
• Number of axes for vector control, max.	6
• Number of axes for V/f control, max.	12
• Remark	Alternative control modes; drive control based on SINAMICS S120 CU320-2 (firmware version V5.x); functional subset compared to CU320-2: no DCC/DCB, EPOS, free function blocks, etc.); see manual for details
Supply voltage	
Type of supply voltage	24 V DC
Memory	
Work memory	
• integrated (for program)	6 Mbyte
• integrated (for data)	20 Mbyte
Load memory	
• Plug-in (SIMATIC Memory Card), required	12 Mbyte; Recommended at least when integrated drive is used
• Plug-in (SIMATIC Memory Card), max.	32 Gbyte
Counters, timers and their retentivity	
S7 counter	
• Number	2 048
IEC counter	
• Number	Any (only limited by the main memory)

Article number	6ES7615-7DF10-0AB0 SIMATIC Drive Controller, CPU 1507D TF
S7 times	
• Number	2 048
IEC timer	
• Number	Any (only limited by the main memory)
Data areas and their retentivity	
Flag	
• Number, max.	16 kbyte
Address area	
I/O address area	
• Inputs	32 kbyte; All inputs are in the process image
• Outputs	32 kbyte; All outputs are in the process image
Time of day	
Clock	
• Type	Hardware clock
Digital inputs	
integrated channels (DI)	28; max. depending on parameterization
Digital outputs	
integrated channels (DO)	16; max. depending on parameterization
Digital outputs, parameterizable	Yes; 8 DI/DQ (X122/X132, SINAMICS Integrated) + 8 DI/DQ (X142, PLC)
Short-circuit protection	Yes; electronic/thermal
1. Interface	
Interface types	
• Number of ports	3
• integrated switch	Yes
• RJ 45 (Ethernet)	Yes; X150

Drive Controllers

Technology CPUs

CPU 1507D TF

Technical specifications

Article number	6ES7615-7DF10-0AB0 SIMATIC Drive Controller, CPU 1507D TF
Protocols	
• IP protocol	Yes; IPv4
• PROFINET IO Controller	Yes
• PROFINET IO Device	Yes
• SIMATIC communication	Yes
• Open IE communication	Yes; Optionally also encrypted
• Web server	Yes
• Media redundancy	Yes; MRP Automanager according to IEC 62439-2 Edition 2.0
PROFINET IO Controller	
Services	
- PG/OP communication	Yes
- S7 routing	Yes
- Isochronous mode	Yes
- Direct data exchange	Yes; Requirement: IRT and isochronous mode (MRPD optional)
- shortest clock pulse	500 µs
- Open IE communication	Yes
- IRT	Yes
- MRP	Yes; MRP Automanager acc. to IEC 62439-2 Edition 2.0; MRP Manager; MRP Client; max. number of devices in the ring: 50
- MRPD	Yes; Requirement: IRT
- PROFINergy	Yes
- Prioritized startup	Yes; Max. 32 PROFINET devices
- Number of connectable IO Devices, max.	256; In total, up to 1 000 distributed I/O devices can be connected via AS-i, PROFIBUS or PROFINET
- Of which IO devices with IRT, max.	64
- Number of connectable IO Devices for RT, max.	256
- of which in line, max.	256
- Number of IO Devices that can be simultaneously activated/deactivated, max.	8; in total across all interfaces
- Number of IO Devices per tool, max.	8
- Updating times	The minimum value of the update time also depends on communication share set for PROFINET IO, on the number of IO devices, and on the quantity of configured user data
Update time for IRT	
- for send cycle of 500 µs	500 µs to 8 ms
- for send cycle of 1 ms	1 ms to 16 ms
- for send cycle of 2 ms	2 ms to 32 ms
- for send cycle of 4 ms	4 ms to 64 ms
- With IRT and parameterization of "odd" send cycles	Update time = set "odd" send clock (any multiple of 125 µs: 375 µs, 625 µs ... 3 875 µs)
Update time for RT	
- for send cycle of 500 µs	500 µs to 256 ms
- for send cycle of 1 ms	1 ms to 512 ms
- for send cycle of 2 ms	2 ms to 512 ms
- for send cycle of 4 ms	4 ms to 512 ms

Article number	6ES7615-7DF10-0AB0 SIMATIC Drive Controller, CPU 1507D TF
PROFINET IO Device	
Services	
- PG/OP communication	Yes
- S7 routing	Yes
- Isochronous mode	No
- shortest clock pulse	500 µs
- Open IE communication	Yes
- IRT	Yes
- MRP	Yes; MRP Automanager acc. to IEC 62439-2 Edition 2.0; MRP Manager; MRP Client; max. number of devices in the ring: 50
- MRPD	Yes; Requirement: IRT
- PROFINergy	Yes; per user program
- Shared device	Yes
- Number of IO Controllers with shared device, max.	4
- Asset management record	Yes; per user program
2. Interface	
Interface types	
• Number of ports	1
• integrated switch	No
• RJ 45 (Ethernet)	Yes; X160
Protocols	
• IP protocol	Yes; IPv4
• PROFINET IO Controller	Yes
• PROFINET IO Device	Yes
• SIMATIC communication	Yes
• Open IE communication	Yes; Optionally also encrypted
• Web server	Yes
• Media redundancy	No
PROFINET IO Controller	
Services	
- PG/OP communication	Yes
- S7 routing	Yes
- Isochronous mode	No
- Direct data exchange	No
- Open IE communication	Yes
- IRT	No
- MRP	No
- MRPD	No
- PROFINergy	Yes
- Prioritized startup	No
- Number of connectable IO Devices, max.	128; In total, up to 1 000 distributed I/O devices can be connected via AS-i, PROFIBUS or PROFINET
- Number of connectable IO Devices for RT, max.	128
- of which in line, max.	128
- Number of IO Devices that can be simultaneously activated/deactivated, max.	8; in total across all interfaces
- Number of IO Devices per tool, max.	8
- Updating times	The minimum value of the update time also depends on communication share set for PROFINET IO, on the number of IO devices, and on the quantity of configured user data

Technical specifications

Article number	6ES7615-7DF10-0AB0 SIMATIC Drive Controller, CPU 1507D TF
Update time for RT - for send cycle of 1 ms	1 ms to 512 ms
PROFINET IO Device	
Services	
- PG/OP communication	Yes
- S7 routing	Yes
- Isochronous mode	No
- Open IE communication	Yes
- IRT	No
- MRP	No
- MRPD	No
- PROFinergy	Yes; per user program
- Prioritized startup	No
- Shared device	Yes
- Number of IO Controllers with shared device, max.	4
- Asset management record	Yes; per user program
3. Interface	
Interface types	
• Number of ports	1
• integrated switch	No
• RJ 45 (Ethernet)	Yes; X130
Protocols	
• IP protocol	Yes; IPv4
• PROFINET IO Controller	No
• PROFINET IO Device	No
• SIMATIC communication	Yes
• Open IE communication	Yes
• Web server	Yes
4. Interface	
Interface types	
• Number of ports	1
• RS 485	Yes; X126
Protocols	
• PROFIBUS DP master	Yes
• PROFIBUS DP slave	No
• SIMATIC communication	Yes
Protocols	
Number of connections	
• Number of connections, max.	320; Via integrated interfaces of the CPU
PROFIBUS DP master	
Services	
- Number of DP slaves	125; In total, up to 1 000 distributed I/O devices can be connected via AS-i, PROFIBUS or PROFINET
OPC UA	
• OPC UA client	Yes
• OPC UA server	Yes; Data access (read, write, subscribe), method call, custom address space
Isochronous mode	
Isochronous operation (application synchronized up to terminal)	Yes; With minimum OB 6x cycle of 500 µs

Article number	6ES7615-7DF10-0AB0 SIMATIC Drive Controller, CPU 1507D TF
Supported technology objects	
Motion Control	Yes
• Number of available Motion Control resources for technology objects	12 800
• Required Motion Control resources	
- per speed-controlled axis	40
- per positioning axis	80
- per synchronous axis	160
- per external encoder	80
- per output cam	20
- per cam track	160
- per probe	40
• Number of available Extended Motion Control resources for technology objects	420
• Required Extended Motion Control resources	
- for each cam	2
- for each set of kinematics	30
- Per leading axis proxy	3
Controller	
• PID_Compact	Yes; Universal PID controller with integrated optimization
• PID_3Step	Yes; PID controller with integrated optimization for valves
• PID-Temp	Yes; PID controller with integrated optimization for temperature
Counting and measuring	
• High-speed counter	Yes
Standards, approvals, certificates	
Highest safety class achievable in safety mode	
Probability of failure (for service life of 20 years and repair time of 100 hours)	
- Low demand mode: PFDavg in accordance with SIL2	< 14.00E-04
- Low demand mode: PFDavg in accordance with SIL3 (if exclusively F-CPU is used)	< 2.00E-05 PLd
- High demand/continuous mode: PFH in accordance with SIL2	< 14.00E-09
- High demand/continuous mode: PFH in accordance with SIL3	< 1.00E-09 (if exclusively F-CPU is used)
Ambient conditions	
Ambient temperature during operation	
• min.	0 °C
• max.	55 °C
Altitude during operation relating to sea level	
• Installation altitude above sea level, max.	4 000 m; Above an altitude of 2 000 m, the max. ambient temperature decreases by 7 °C every 1 000 m
• Ambient air temperature-barometric pressure-altitude	Permissible air pressure: 620 hPa ... 1 060 hPa

Drive Controllers

Technology CPUs

CPU 1507D TF

Technical specifications

Article number	6ES7615-7DF10-0AB0 SIMATIC Drive Controller, CPU 1507D TF
Configuration	
Programming	
Programming language	
- LAD	Yes; incl. failsafe
- FBD	Yes; incl. failsafe
- STL	Yes
- SCL	Yes
- GRAPH	Yes
Know-how protection	
• User program protection/password protection	Yes
• Copy protection	Yes
• Block protection	Yes

Article number	6ES7615-7DF10-0AB0 SIMATIC Drive Controller, CPU 1507D TF
Access protection	
• Protection level: Write protection	Yes
• Protection level: Read/write protection	Yes
• Protection level: Write protection for Failsafe	Yes
• Protection level: Complete protection	Yes
Dimensions	
Width	50 mm
Height	300 mm
Depth	226 mm; 270 mm with spacer (included in scope of supply)
Weights	
Weight, approx.	2 200 g
Other	
Note:	fanless operation

Ordering data

Article No.	Article No.
SIMATIC S7-1500 CPU 1507D TF drive controller With SINAMICS S120 Integrated; Fail-safe technology CPU; Work memory: 6 MB for program, 20 MB for data; Interfaces: 12 DI, 16 DI/DQ, 4 DRIVE-CLiQ, 3 PROFINET; 3+1+1 ports, 1 PROFIBUS; SIMATIC Memory Card required	6ES7615-7DF10-0AB0
Accessories	
SIMATIC Memory Card ¹⁾	
• 4 MB	6ES7954-8LC03-0AA0
• 12 MB	6ES7954-8LE03-0AA0
• 24 MB	6ES7954-8LF03-0AA0
• 256 MB	6ES7954-8LL03-0AA0
• 2 GB	6ES7954-8LP02-0AA0
• 32 GB	6ES7954-8LT03-0AA0
<i>Drive licenses for integrated drive control</i>	
Safety Integrated Extended Functions License certificate for a SINAMICS S120 axis	6SL3074-0AA10-0AA0
Safety Integrated Advanced Functions License certificate for a SINAMICS S120 axis Additional SINAMICS licenses (technology extension VIBX, ...) available soon.	6SL3074-0AA20-0AA0

Article No.	Article No.
<i>Control licenses</i>	
SIMATIC OPC UA S7-1500 Large Required for CPU 1507D TF Single runtime license	
• License certificate for OPC UA server (data access and OPC UA client)	6ES7823-0BA00-1DA0
• Download incl. license certificate for OPC UA server (data access and OPC UA client) ³⁾ Email address required for delivery	6ES7823-0BE00-1DA0
<i>Accessories for PROFIBUS (interface X126)</i>	
PROFIBUS RS485 bus connection plug With angular cable outlet (35°) with screw-type terminals, max. transmission rate 12 Mbps	
• Without PG/PC interface	6ES7972-0BA42-0XA0
• With PG/PC interface	6ES7972-0BB42-0XA0

¹⁾ When using the integrated SINAMICS S120 drive control, a memory card size of at least 12 MB is recommended. A memory card size of at least 256 MB is required for firmware updates.

³⁾ For up-to-date information and download availability, see: <http://www.siemens.com/tia-online-software-delivery>

Ordering data	Article No.	Article No.
PROFIBUS FastConnect RS485 bus connection plug With angular cable outlet (35°) with insulation displacement technology, max. transmission rate 12 Mbps <ul style="list-style-type: none"> Without PG/PC interface With PG/PC interface 	6ES7972-0BA61-0XA0 6ES7972-0BB61-0XA0	IE FC Stripping Tool Pre-adjusted Stripping Tool for fast stripping of Industrial Ethernet FC cables
FastConnect cables for PROFIBUS (sold by the meter; max. length 1 000 m; minimum order quantity 20 m) <ul style="list-style-type: none"> FC standard cable GP FC robust cable FC flexible cable FC trailing cable, sheath color: Petrol FC trailing cable, sheath color: Violet FC food cable FC ground cable FC FRNC cable GP 	6XV1830-0EH10 6XV1830-0JH10 6XV1831-2K 6XV1830-3EH10 6XV1831-2L 6XV1830-0GH10 6XV1830-3FH10 6XV1830-0LH10	Dust protection blanking plugs For sealing unused DRIVE-CLiQ and PROFINET ports; blanking plug (50 units)
<i>Accessories for PROFINET (interface X150 and X160; X130 only up to 100 Mbps)</i>		<i>PLC Engineering Software</i>
IE FC RJ45 plug 145 145° cable outlet (10/100 Mbps) <ul style="list-style-type: none"> 1 unit 10 units 50 units 	6GK1901-1BB30-0AA0 6GK1901-1BB30-0AB0 6GK1901-1BB30-0AE0	STEP 7 Professional V16 <i>Target system:</i> SIMATIC S7-1200, S7-1500, S7-300, S7-400, WinAC <i>Requirement:</i> Windows 7 Professional SP1 Windows 7 Enterprise SP1 Windows 7 Ultimate SP1 Windows 10 Professional Version 1809, 1903 Windows 10 Enterprise Version 1809, 1903 Windows 10 IoT Enterprise 2015 LTSB Windows 10 IoT Enterprise 2016 LTSB Windows 10 IoT Enterprise 2019 LTSC Windows Server 2012 R2 StdE (full installation) Windows Server 2016 Standard (full installation) Windows Server 2019 Standard (full installation) <i>Type of delivery:</i> German, English, Chinese, Italian, French, Spanish
FastConnect cables for Industrial Ethernet/PROFINET (sold by the meter; max. length 1 000 m; minimum order quantity 20 m) <ul style="list-style-type: none"> IE FC standard cable GP 2x2 IE FC flexible cable GP 2x2 IE FC trailing cable GP 2x2 IE FC trailing cable 2x2 IE FC marine cable 2x2 	6XV1840-2AH10 6XV1870-2B 6XV1870-2D 6XV1840-3AH10 6XV1840-4AH10	6ES7822-1AA06-0YA5 6ES7822-1AE06-0YA5
<i>Accessories for PROFINET²⁾ (interface X130, for up to 1 000 Mbps)</i>		STEP 7 Professional V16, floating license STEP 7 Professional V16, floating license, software download including license key ³⁾ Email address required for delivery
IE FC RJ45 plug 180 180° cable outlet (10/100/1 000 Mbps) <ul style="list-style-type: none"> 1 unit 10 units 50 units 	6GK1901-1BB11-2AA0 6GK1901-1BB11-2AB0 6GK1901-1BB11-2AE0	
FastConnect cables for Industrial Ethernet/PROFINET (sold by the meter; max. length 1 000 m; minimum order quantity 20 m) <ul style="list-style-type: none"> IE FC standard cable GP 4x2 IE FC flexible cable GP 4x2 	6XV1878-2A 6XV1878-2B	
<i>Other accessories</i>		
PROFIBUS FastConnect Stripping Tool Pre-adjusted Stripping Tool for fast stripping of PROFIBUS FastConnect bus cables	6GK1905-6AA00	

²⁾ The Ethernet interface X130 supports 10, 100 and 1 000 Mbps. For 1 000 Mbps, 8-wire cables (4x2) and the 180° FastConnect connector in 1 000 Mbps version must be used.

³⁾ For up-to-date information and download availability, see: <http://www.siemens.com/tia-online-software-delivery>

Drive Controllers

Technology CPUs

CPU 1507D TF

Ordering data

STEP 7 Safety Advanced V16

Task:

Engineering tool for configuring and programming fail-safe user programs for SIMATIC S7-1200 FC, S7-1500F, S7-1500F Software Controller, S7-300F, S7-400F, WinAC RTX F, ET 200SP F Controller and the fail-safe ET 200SP, ET 200MP, ET 200S, ET 200M, ET 200iSP, ET 200pro and ET 200eco I/O

Requirement:

STEP 7 Professional V16

Note:

As from TIA Portal V16, the SIMATIC STEP 7 Safety software is an integral part of the SIMATIC STEP 7 product setup. The functionality of SIMATIC STEP 7 Safety is activated by means of the license key supplied in each case.

Floating license for 1 user;
license key on USB flash drive

Floating license for 1 user,
license key for download ³⁾;
email address required for delivery

Documentation

SIMATIC Manual Collection

Electronic manuals on DVD,
multilingual

SIMATIC Manual Collection Update service for 1 year

Current Manual Collection DVD and
the three subsequent updates

Article No.

6ES7833-1FA16-0YA5

6ES7833-1FA16-0YH5

6ES7998-8XC01-8YE0

6ES7998-8XC01-8YE2

Article No.

*Engineering software for
SINAMICS drives*

SINAMICS Startdrive ⁴⁾ Basic V16

TIA Portal engineering and
commissioning tool for
SINAMICS drives

- DVD
- OSD / software download ³⁾
Email address required
for delivery

6SL3072-4GA02-0XA0
6SL3072-4GA02-0XG0

SINAMICS Startdrive Advanced V16

TIA Portal engineering and
commissioning tool for SINAMICS
drives;
Advanced version including safety
acceptance testing for the
SINAMICS G120,
SINAMICS S120 and
SINAMICS S210 converter series

- DVD
- OSD / software download ³⁾
Email address required
for delivery

6SL3072-4GA02-0XA5
6SL3072-4GA02-0XG5

³⁾ For up-to-date information and download availability, see:
<http://www.siemens.com/tia-online-software-delivery>

⁴⁾ The SINAMICS Startdrive Basic commissioning tool is available for free on
the Internet at: <https://www.siemens.com/startdrive>

I/O systems



10/2	SIMATIC ET 200 systems for the control cabinet
10/2	SIMATIC ET 200SP
10/2	<u>Interface modules</u>
10/2	SIPLUS interface modules
10/5	<u>I/O modules</u>
10/5	Analog output modules
10/13	SIPLUS analog inputs
10/20	Technology modules
10/20	- TM Count 1x24V counter module
10/24	- SIWAREX WP351
10/26	- SIPLUS ET 200SP ECC charging controller
10/28	- SIPLUS SIWAREX WP321
10/31	Communication
10/31	- CM 1xDALI
10/33	- CM CAN
10/34	Fail-safe I/O modules
10/34	- Analog F-input modules
10/38	- SIPLUS analog F-input modules
10/40	SIMATIC ET 200SP drive controllers
10/40	- SIMATIC MICRO-DRIVE F-TM ServoDrive
10/42	ET 200SP motor starters
10/52	Accessories
10/52	- SIPLUS server module
10/53	SIMATIC ET 200SP HA
10/54	Interface module
10/56	Digital I/O modules
10/63	Analog I/O modules
10/68	Analog/digital module
10/71	Carrier modules
10/74	Terminal blocks
10/77	BusAdapter
10/79	SIMATIC ET 200MP
10/79	Interface modules
10/79	- SIPLUS IM 155-5 PN
10/81	- SIPLUS IM 155-5 DP
10/82	Active backplane bus
10/83	SIMATIC ET 200M
10/83	Interface modules
10/83	- SIPLUS ET 200M IM 153-4 PN IO
10/85	SIMATIC ET 200iSP
10/85	Stainless steel wall enclosure
10/86	IO systems for heating elements
10/86	IO systems for heating elements with integrated power outputs - modular design
10/86	SIPLUS HCS4200 heating control system
10/86	- Central Interface Module (CIM)
10/89	SIPLUS HCS4300 heating control system
10/89	- Power Output Module (POM)
10/94	Network transitions
10/94	Power Line Booster
10/97	SIPLUS PN/CAN LINK

I/O systems

SIMATIC ET 200 systems for the control cabinet
SIMATIC ET 200SP

Interface modules > SIPLUS interface modules

Overview



- Interface module for linking the I/O modules to a higher-level controller with PROFINET or PROFIBUS
- Server module included in the scope of supply
- Station expansion with IP67 I/O system ET 200AL via ET-connection to BU-Send / BA-Send
- PROFINET bus connection
 - 2 ports for line configuration
 - PN connection selected via BusAdapter (ST, HF)
 - Two integrated RJ45 sockets (BA)
- PROFIBUS bus connection
 - 9-pin sub D socket
 - PROFIBUS connector included in scope of supply
 - Hot swapping (module replacement during operation)
 - Startup and operation with gaps
 - Dynamic re-parameterization in RUN mode
 - Configuration control (option handling)
 - Pluggable 24 V DC supply connector
 - Electronically readable rating plate (I&M data)

Note:

SIPLUS extreme products are based on SIMATIC standard products. The contents listed here were taken from the respective standard products. SIPLUS extreme-specific information was added.

Technical specifications

Article number	6AG1155-6AA01-7BNO	6AG1155-6AU01-2CNO	6AG1155-6AU01-7CNO	6AG1155-6AU01-7BNO	6AG1155-6BA01-7CNO
Based on	6ES7155-6AA01-0BNO	6ES7155-6AU01-0CNO	6ES7155-6AU01-0CNO	6ES7155-6AU01-0BNO	6ES7155-6BA01-0CNO
	SIPLUS ET 200SP IM155-6PN ST / BA	SIPLUS ET 200SP IM155-6PN HF	SIPLUS ET 200SP IM155-6PN HF	SIPLUS ET 200SP IM155-6PN ST	SIPLUS ET 200SP IM155-6DP HF
Ambient conditions					
Ambient temperature during operation					
• horizontal installation, min.	-40 °C; = Tmin (incl. condensation/frost)	-40 °C; = Tmin (incl. condensation/frost)	-40 °C; = Tmin (incl. condensation/frost)	-40 °C; = Tmin (incl. condensation/frost)	-40 °C; = Tmin (incl. condensation/frost)
• horizontal installation, max.	70 °C; = Tmax	60 °C; = Tmax	70 °C; = Tmax	70 °C; = Tmax	70 °C; = Tmax
• vertical installation, min.	-40 °C; = Tmin	-40 °C; = Tmin (incl. condensation/frost)	-40 °C; = Tmin (incl. condensation/frost)	-40 °C; = Tmin	-40 °C; = Tmin (incl. condensation/frost)
• vertical installation, max.	50 °C; = Tmax	50 °C; = Tmax	50 °C; = Tmax	50 °C; = Tmax	50 °C; = Tmax
Altitude during operation relating to sea level					
• Installation altitude above sea level, max.	5 000 m	5 000 m	5 000 m	5 000 m	5 000 m
• Ambient air temperature-barometric pressure-altitude	Tmin ... Tmax at 1 140 hPa ... 795 hPa (-1 000 m ... +2 000 m) // Tmin ... (Tmax - 10 K) at 795 hPa ... 658 hPa (+2 000 m ... +3 500 m) // Tmin ... (Tmax -20 K) at 658 hPa ... 540 hPa (+3 500 m ... +5 000 m)	Tmin ... Tmax at 1 140 hPa ... 795 hPa (-1 000 m ... +2 000 m) // Tmin ... (Tmax - 10 K) at 795 hPa ... 658 hPa (+2 000 m ... +3 500 m) // Tmin ... (Tmax -20 K) at 658 hPa ... 540 hPa (+3 500 m ... +5 000 m)	Tmin ... Tmax at 1 140 hPa ... 795 hPa (-1 000 m ... +2 000 m) // Tmin ... (Tmax - 10 K) at 795 hPa ... 658 hPa (+2 000 m ... +3 500 m) // Tmin ... (Tmax -20 K) at 658 hPa ... 540 hPa (+3 500 m ... +5 000 m)	Tmin ... Tmax at 1 140 hPa ... 795 hPa (-1 000 m ... +2 000 m) // Tmin ... (Tmax - 10 K) at 795 hPa ... 658 hPa (+2 000 m ... +3 500 m) // Tmin ... (Tmax -20 K) at 658 hPa ... 540 hPa (+3 500 m ... +5 000 m)	Tmin ... Tmax at 1 140 hPa ... 795 hPa (-1 000 m ... +2 000 m) // Tmin ... (Tmax - 10 K) at 795 hPa ... 658 hPa (+2 000 m ... +3 500 m) // Tmin ... (Tmax -20 K) at 658 hPa ... 540 hPa (+3 500 m ... +5 000 m)
Relative humidity					
• With condensation, tested in accordance with IEC 60068-2-38, max.	100 %; RH incl. condensation / frost (no commissioning in bedewed state), horizontal installation	100 %; RH incl. condensation / frost (no commissioning in bedewed state), horizontal installation	100 %; RH incl. condensation / frost (no commissioning in bedewed state), horizontal installation	100 %; RH incl. condensation / frost (no commissioning in bedewed state), horizontal installation	100 %; RH incl. condensation / frost (no commissioning in bedewed state), horizontal installation
Resistance					
Coolants and lubricants					
- Resistant to commercially available coolants and lubricants	Yes; Incl. diesel and oil droplets in the air	Yes; Incl. diesel and oil droplets in the air	Yes; Incl. diesel and oil droplets in the air	Yes; Incl. diesel and oil droplets in the air	Yes; Incl. diesel and oil droplets in the air

Technical specifications

Article number	6AG1155-6AA01-7BNO	6AG1155-6AU01-2CNO	6AG1155-6AU01-7CNO	6AG1155-6AU01-7BNO	6AG1155-6BA01-7CNO
Based on	6ES7155-6AA01-0BNO	6ES7155-6AU01-0CNO	6ES7155-6AU01-0CNO	6ES7155-6AU01-0BNO	6ES7155-6BA01-0CNO
	SIPLUS ET 200SP IM155-6PN ST / BA	SIPLUS ET 200SP IM155-6PN HF	SIPLUS ET 200SP IM155-6PN HF	SIPLUS ET 200SP IM155-6PN ST	SIPLUS ET 200SP IM155-6DP HF
Use in stationary industrial systems					
- to biologically active substances according to EN 60721-3-3	Yes; Class 3B2 mold, fungus and dry rot spores (with the exception of fauna); Class 3B3 on request	Yes; Class 3B2 mold, fungus and dry rot spores (with the exception of fauna); Class 3B3 on request	Yes; Class 3B2 mold, fungus and dry rot spores (with the exception of fauna); Class 3B3 on request	Yes; Class 3B2 mold, fungus and dry rot spores (with the exception of fauna); Class 3B3 on request	Yes; Class 3B2 mold, fungus and dry rot spores (with the exception of fauna); Class 3B3 on request
- to chemically active substances according to EN 60721-3-3	Yes; Class 3C4 (RH < 75 %) incl. salt spray acc. to EN 60068-2-52 (severity degree 3); *	Yes; Class 3C4 (RH < 75 %) incl. salt spray acc. to EN 60068-2-52 (severity degree 3); *	Yes; Class 3C4 (RH < 75 %) incl. salt spray acc. to EN 60068-2-52 (severity degree 3); *	Yes; Class 3C4 (RH < 75 %) incl. salt spray acc. to EN 60068-2-52 (severity degree 3); *	Yes; Class 3C4 (RH < 75 %) incl. salt spray acc. to EN 60068-2-52 (severity degree 3); *
- to mechanically active substances according to EN 60721-3-3	Yes; Class 3S4 incl. sand, dust, *	Yes; Class 3S4 incl. sand, dust, *	Yes; Class 3S4 incl. sand, dust, *	Yes; Class 3S4 incl. sand, dust, *	Yes; Class 3S4 incl. sand, dust, *
- Against mechanical environmental conditions acc. to EN 60721-3-3		Yes; Class 3M8 using the SIPLUS Mounting Kit ET 200SP (6AG1193-6AA00-0AA0)	Yes; Class 3M8 using the SIPLUS Mounting Kit ET 200SP (6AG1193-6AA00-0AA0)	Yes; Class 3M8 using the SIPLUS Mounting Kit ET 200SP (6AG1193-6AA00-0AA0)	Yes; Class 3M8 using the SIPLUS Mounting Kit ET 200SP (6AG1193-6AA00-0AA0)
Use on ships/at sea					
- to biologically active substances according to EN 60721-3-6	Yes; Class 6B2 mold and fungal spores (excluding fauna); Class 6B3 on request	Yes; Class 6B2 mold, fungal and dry rot spores (excluding fauna)	Yes; Class 6B2 mold, fungal and dry rot spores (excluding fauna)	Yes; Class 6B2 mold and fungal spores (excluding fauna); Class 6B3 on request	Yes; Class 6B2 mold, fungal and dry rot spores (excluding fauna)
- to chemically active substances according to EN 60721-3-6	Yes; Class 6C3 (RH < 75 %) incl. salt spray acc. to EN 60068-2-52 (severity degree 3); *	Yes; Class 6C3 (RH < 75 %) incl. salt spray acc. to EN 60068-2-52 (severity degree 3); *	Yes; Class 6C3 (RH < 75 %) incl. salt spray acc. to EN 60068-2-52 (severity degree 3); *	Yes; Class 6C3 (RH < 75 %) incl. salt spray acc. to EN 60068-2-52 (severity degree 3); *	Yes; Class 6C3 (RH < 75 %) incl. salt spray acc. to EN 60068-2-52 (severity degree 3); *
- to mechanically active substances according to EN 60721-3-6	Yes; Class 6S3 incl. sand, dust; *	Yes; Class 6S3 incl. sand, dust; *	Yes; Class 6S3 incl. sand, dust; *	Yes; Class 6S3 incl. sand, dust; *	Yes; Class 6S3 incl. sand, dust; *
- Against mechanical environmental conditions acc. to EN 60721-3-6		Yes; Class 6M4 using the SIPLUS Mounting Kit ET 200SP (6AG1193-6AA00-0AA0)	Yes; Class 6M4 using the SIPLUS Mounting Kit ET 200SP (6AG1193-6AA00-0AA0)	Yes; Class 6M4 using the SIPLUS Mounting Kit ET 200SP (6AG1193-6AA00-0AA0)	Yes; Class 6M4 using the SIPLUS Mounting Kit ET 200SP (6AG1193-6AA00-0AA0)
Usage in industrial process technology					
- Against chemically active substances acc. to EN 60654-4	Yes; Class 3 (excluding trichlorethylene)	Yes; Class 3 (excluding trichlorethylene)	Yes; Class 3 (excluding trichlorethylene)	Yes; Class 3 (excluding trichlorethylene)	Yes; Class 3 (excluding trichlorethylene)
- Environmental conditions for process, measuring and control systems acc. to ANSI/ISA-71.04	Yes; Level GX group A/B (excluding trichlorethylene; harmful gas concentrations up to the limits of EN 60721-3-3 class 3C4 permissible); level LC3 (salt spray) and level LB3 (oil)	Yes; Level GX group A/B (excluding trichlorethylene; harmful gas concentrations up to the limits of EN 60721-3-3 class 3C4 permissible); level LC3 (salt spray) and level LB3 (oil)	Yes; Level GX group A/B (excluding trichlorethylene; harmful gas concentrations up to the limits of EN 60721-3-3 class 3C4 permissible); level LC3 (salt spray) and level LB3 (oil)	Yes; Level GX group A/B (excluding trichlorethylene; harmful gas concentrations up to the limits of EN 60721-3-3 class 3C4 permissible); level LC3 (salt spray) and level LB3 (oil)	Yes; Level GX group A/B (excluding trichlorethylene; harmful gas concentrations up to the limits of EN 60721-3-3 class 3C4 permissible); level LC3 (salt spray) and level LB3 (oil)
Remark					
- Note regarding classification of environmental conditions acc. to EN 60721, EN 60654-4 and ANSI/ISA-71.04	* The supplied plug covers must remain in place over the unused interfaces during operation!	* The supplied plug covers must remain in place over the unused interfaces during operation!	* The supplied plug covers must remain in place over the unused interfaces during operation!	* The supplied plug covers must remain in place over the unused interfaces during operation!	* The supplied plug covers must remain in place over the unused interfaces during operation!

I/O systems

SIMATIC ET 200 systems for the control cabinet
SIMATIC ET 200SP

Interface modules > SIPLUS interface modules

Technical specifications

Article number	6AG1155-6AA01-7BN0	6AG1155-6AU01-2CN0	6AG1155-6AU01-7CN0	6AG1155-6AU01-7BN0	6AG1155-6BA01-7CN0
Based on	6ES7155-6AA01-0BN0	6ES7155-6AU01-0CN0	6ES7155-6AU01-0CN0	6ES7155-6AU01-0BN0	6ES7155-6BA01-0CN0
	SIPLUS ET 200SP IM155-6PN ST / BA	SIPLUS ET 200SP IM155-6PN HF	SIPLUS ET 200SP IM155-6PN HF	SIPLUS ET 200SP IM155-6PN ST	SIPLUS ET 200SP IM155-6DP HF
Conformal coating					
• Coatings for printed circuit board assemblies acc. to EN 61086	Yes; Class 2 for high availability	Yes; Class 2 for high availability	Yes; Class 2 for high availability	Yes; Class 2 for high availability	Yes; Class 2 for high availability
• Protection against fouling acc. to EN 60664-3	Yes; Type 1 protection	Yes; Type 1 protection	Yes; Type 1 protection	Yes; Type 1 protection	Yes; Type 1 protection
• Military testing according to MIL-I-46058C, Amendment 7	Yes; Discoloration of coating possible during service life	Yes; Discoloration of coating possible during service life	Yes; Discoloration of coating possible during service life	Yes; Discoloration of coating possible during service life	Yes; Discoloration of coating possible during service life
• Qualification and Performance of Electrical Insulating Compound for Printed Board Assemblies according to IPC-CC-830A	Yes; Conformal coating, Class A	Yes; Conformal coating, Class A	Yes; Conformal coating, Class A	Yes; Conformal coating, Class A	Yes; Conformal coating, Class A

Ordering data

Article No.

SIPLUS PROFINET IM155-6PN Standard interface module

(Extended temperature range and medial exposure)

IM 155-6PN ST, with server module and installed BA 2xRJ45 BusAdapter, plus extended power failure backup time

6AG1155-6AA01-7BN0

SIPLUS interface module High Feature

(Extended temperature range and medial exposure)

IM 155-6DP HF, with server module, with multi-hot-swap, incl. PROFIBUS connector

IM 155-6PN HF, incl. server module, without BusAdapter

- Temperature range -40...+60 °C
- Temperature range -40...+70 °C

IM 155-6PN HF, including server module, without BusAdapter, plus extended power failure backup time

6AG1155-6BA01-7CN0

6AG1155-6AU01-2CN0

6AG1155-6AU01-7CN0

6AG1155-6AU01-7BN0

Accessories

See SIMATIC ET 200SP, IM 155-6 interface module, catalog ST 70 · 2019, page 9/14

Overview



- 2 and 4-channel analog output (AQ) modules
- Apart from the standard type of delivery in an individual package, selected I/O modules and BaseUnits are also available in a pack of 10 units. The pack of 10 units enables the amount of waste to be reduced considerably, as well as saving the time and cost of unpacking individual modules.

For different requirements, the analog output modules offer:

- Function classes Standard, High Feature and High-Speed
- BaseUnits for single or multiple-conductor connection with automatic slot coding
- Potential distributor modules for system-integrated expansion with potential terminals

- Individual system-integrated load group formation with self-assembling voltage distribution bars (a separate power module is no longer required for ET 200SP)
- Option for connecting current and voltage actuators
- Clear labeling on front of module
- LEDs for diagnostics, status, supply voltage and faults
- Electronically readable and non-volatile writable rating plate (I&M data 0 to 3)
- Extended functions and additional operating modes in some cases
 - Oversampling operating mode (n-fold equidistant output of an analog value within one PN cycle and thus the precisely timed output of an analog value or a sequence of analog values)
 - Isochronous mode (simultaneous equidistant output of analog values)
 - Output of substitute value in the event of interruptions to communication (shutdown, output adjustable substitute value, or keep last value)
 - Calibration during runtime
 - Re-parameterization during operation
 - Firmware update
 - Diagnostics of wire break, short circuit, overflow, underflow
 - Value status (optional binary validity information of the analog value status in the process image)
 - Supports the PROFlenergy profile
- Optional accessories
 - Labeling strips (film or card)
 - Equipment labeling plate
 - Color-coded label with module-specific CC code
 - Shielding terminal

A quick and clear comparison of the functions of the AQ modules is offered by the TIA Selection Tool.

Overview of analog output modules

Analog output	PU	Article No.	CC code	BU type
AQ 2 x U ST	1	6ES7135-6FB00-0BA1	CC00	A0, A1
AQ 2 x I ST	1	6ES7135-6GB00-0BA1	CC00	A0, A1
AQ 4 x U/I ST	1	6ES7135-6HD00-0BA1	CC00	A0, A1
AQ 2 x U/I HF	1	6ES7135-6HB00-0CA1	CC00	A0, A1
AQ 2xU/I HS	1	6ES7135-6HB00-0DA1	CC00	A0, A1
With two operating modes:				
• High-speed isochronous AQ				
• Oversampling				
AQ 4xI HART HF	1	6ES7135-6TD00-0CA1	CC00	A0, A1

I/O systemsSIMATIC ET 200 systems for the control cabinet
SIMATIC ET 200SP**I/O modules > Analog output modules****Overview****Overview of BaseUnits**

BaseUnit	PU	Article No.	CC codes for push-in terminals	CC codes for AUX terminals
BU type A0 • New load group (light) • 16 push-in terminals • With 10 AUX terminals	1	6ES7193-6BP20-0DA0	CC01 to CC05	CC71 to CC73
BU type A0 • New load group (light) • 16 push-in terminals • With 10 AUX terminals	10	6ES7193-6BP20-2DA0	CC01 to CC05	CC71 to CC73
BU type A0 • New load group (light) • 16 push-in terminals • Without AUX terminals	1	6ES7193-6BP00-0DA0	CC01 to CC05	--
BU type A0 • New load group (light) • 16 push-in terminals • Without AUX terminals	10	6ES7193-6BP00-2DA0	CC01 to CC05	--
BU type A0 • Forwarding of load group (dark) • 16 push-in terminals • With 10 AUX terminals	1	6ES7193-6BP20-0BA0	CC01 to CC05	CC71 to CC73
BU type A0 • Forwarding of load group (dark) • 16 push-in terminals • With 10 AUX terminals	10	6ES7193-6BP20-2BA0	CC01 to CC05	CC71 to CC73
BU type A0 • Forwarding of load group (dark) • 16 push-in terminals • Without AUX terminals	1	6ES7193-6BP00-0BA0	CC01 to CC05	--
BU type A0 • Forwarding of load group (dark) • 16 push-in terminals • Without AUX terminals	10	6ES7193-6BP00-2BA0	CC01 to CC05	--
BU type A1 • New load group (light) • With temperature sensor • 16 push-in terminals • With 2x5 additional terminals	1	6ES7193-6BP40-0DA1	CC01 to CC05	CC74
BU type A1 • New load group (light) • With temperature sensor • 16 push-in terminals • Without 2x5 additional terminals	1	6ES7193-6BP00-0DA1	CC01 to CC05	--
BU type A1 • Forwarding of load group (dark) • With temperature sensor • 16 push-in terminals • With 2x5 additional terminals	1	6ES7193-6BP40-0BA1	CC01 to CC05	CC74
BU type A1 • Forwarding of load group (dark) • With temperature sensor • 16 push-in terminals • Without 2x5 additional terminals	1	6ES7193-6BP00-0BA1	CC01 to CC05	--

Overview

Overview of potential distributor modules

Potential distributor module	PU	Article No.	CC codes for push-in terminals
PotDis BU Type P1 (light), 17x P1 potential, 1x P2 potential, for starting a new load group (max. 10 A)	1	6ES7193-6UP00-0DP1	CC00, CC62
PotDis BU Type P1 (dark), 17x P1 potential, 1x P2 potential, for continuing the load group	1	6ES7193-6UP00-0BP1	CC00, CC62
PotDis BU Type P2 (light), 1x P1 potential, 17x P2 potential, for starting a new load group (max. 10 A)	1	6ES7193-6UP00-0DP2	CC00, CC63
PotDis BU Type P2 (dark), 1x P1 potential, 17x P2 potential, for continuing the load group	1	6ES7193-6UP00-0BP2	CC00, CC63
PotDis TB Type BR-W, 18x internally jumpered terminals, without reference to P1, P2 or AUX, (total current max. 10 A)	1	6ES7193-6TP00-0TP0	CC10 to CC13
PotDis TB Type P1-R, 18x P1 potential, (total current max. 10 A)	1	6ES7193-6TP00-0TP1	CC10, CC12
PotDis TB Type P2-B, 18x P2 potential, (total current max. 10 A)	1	6ES7193-6TP00-0TP2	CC10, CC13
PotDis TB Type n.c.-G, 18x n.c. (not connected) terminals, without reference to P1, P2 or AUX	1	6ES7193-6TP00-0TN0	CC10

10

Technical specifications

Article number	6ES7135-6FB00-0BA1	6ES7135-6GB00-0BA1	6ES7135-6HD00-0BA1	6ES7135-6HB00-0DA1	6ES7135-6HB00-0CA1
	ET 200SP, AQ 2xU Standard, PU 1	ET 200SP, AQ 2xI Standard, PU 1	ET 200SP, AQ 4xU/I ST	ET 200SP, AQ 2 X U/I High Speed	ET 200SP, AQ 2 X U/I High Feature
General information					
Product type designation	AQ 2xU ST	AQ 2xI ST	AQ 4xU/I ST	AQ 2xU/I HS	AQ 2xU/I HF
Product function					
• I&M data	Yes; I&M0 to I&M3	Yes; I&M0 to I&M3	Yes; I&M0 to I&M3	Yes; I&M0 to I&M3	Yes; I&M0 to I&M3
• Output range scalable	No	No	No		
Engineering with					
• STEP 7 TIA Portal configurable/integrated as of version	V13 SP1 / -	V13 SP1 / -	V11 SP2 / V13	V13 SP1	V13 / V13
• STEP 7 configurable/integrated as of version	V5.5 SP3 / -	V5.5 SP3 / -	V5.5 SP3 / -	V5.5 SP3 / -	V5.5 SP3 / -
• PCS 7 configurable/integrated as of version			V8.1 SP1		V8.1 SP1
• PROFIBUS as of GSD version/GSD revision	GSD Revision 5	GSD Revision 5	One GSD file each, Revision 3 and 5 and higher	GSD Revision 5	GSD Revision 5
• PROFINET as of GSD version/GSD revision	GSDML V2.3	GSDML V2.3	GSDML V2.3	GSDML V2.3	GSDML V2.3
Operating mode					
• Oversampling	No	No	No	Yes; 2 channels per module	No
• MSO	No	No	No	No	No

I/O systemsSIMATIC ET 200 systems for the control cabinet
SIMATIC ET 200SP**I/O modules > Analog output modules****Technical specifications**

Article number	6ES7135-6FB00-0BA1 ET 200SP, AQ 2xU Standard, PU 1	6ES7135-6GB00-0BA1 ET 200SP, AQ 2xI Standard, PU 1	6ES7135-6HD00-0BA1 ET 200SP, AQ 4xU/I ST	6ES7135-6HB00-0DA1 ET 200SP, AQ 2 X U/I High Speed	6ES7135-6HB00-0CA1 ET 200SP, AQ 2 X U/I High Feature
Supply voltage					
Rated value (DC)	24 V	24 V	24 V	24 V	24 V
Reverse polarity protection	Yes	Yes	Yes	Yes	Yes
Analog outputs					
Number of analog outputs	2	2	4	2	2
Cycle time (all channels), min.	1 ms	1 ms	5 ms	125 µs	750 µs
Analog output with oversampling	No	No	No	Yes	
• Values per cycle, max.				16	
• Resolution, min.				45 µs; (2 channels), 35 µs (1 channel)	
Output ranges, voltage					
• 0 to 10 V	Yes; 15 bit		Yes; 15 bit	Yes; 15 bit	Yes; 15 bit
• 1 V to 5 V	Yes; 13 bit		Yes; 13 bit	Yes; 13 bit	Yes; 13 bit
• -5 V to +5 V	Yes; 15 bit incl. sign		Yes; 15 bit incl. sign	Yes; 15 bit incl. sign	Yes; 15 bit incl. sign
• -10 V to +10 V	Yes; 16 bit incl. sign		Yes; 16 bit incl. sign	Yes; 16 bit incl. sign	Yes; 16 bit incl. sign
Output ranges, current					
• 0 to 20 mA		Yes; 15 bit	Yes; 15 bit	Yes; 15 bit	Yes; 15 bit
• -20 mA to +20 mA		Yes; 16 bit incl. sign	Yes; 16 bit incl. sign	Yes; 16 bit incl. sign	Yes; 16 bit incl. sign
• 4 mA to 20 mA		Yes; 14 bit	Yes; 14 bit	Yes; 14 bit	Yes; 14 bit
Connection of actuators					
• for voltage output two-wire connection	Yes		Yes	Yes	Yes
• for voltage output four-wire connection	No		Yes	Yes	Yes
• for current output two-wire connection		Yes	Yes	Yes	Yes
Load impedance (in rated range of output)					
• with voltage outputs, min.	2 kΩ		2 kΩ	2 kΩ	2 kΩ
• with voltage outputs, capacitive load, max.	1 µF		1 µF	1 µF	1 µF
• with current outputs, max.		500 Ω	500 Ω	500 Ω	500 Ω
• with current outputs, inductive load, max.		1 mH	1 mH	1 mH	1 mH
Cable length					
• shielded, max.	200 m	1 000 m	1 000 m; 200 m for voltage output	1 000 m; 200 m for voltage output	1 000 m; 200 m for voltage output
Analog value generation for the outputs					
Integration and conversion time/resolution per channel					
• Resolution with overrange (bit including sign), max.	16 bit	16 bit	16 bit	16 bit	16 bit
Settling time					
• for resistive load	0.1 ms	0.1 ms; Typical value	0.1 ms	0.05 ms	0.05 ms
• for capacitive load	1 ms		1 ms	0.05 ms; Max. 47 nF and 20 m cable length	0.05 ms; Max. 47 nF and 20 m cable length
• for inductive load		0.5 ms	0.5 ms	0.05 ms	0.05 ms

Technical specifications

Article number	6ES7135-6FB00-0BA1	6ES7135-6GB00-0BA1	6ES7135-6HD00-0BA1	6ES7135-6HB00-0DA1	6ES7135-6HB00-0CA1
	ET 200SP, AQ 2xU Standard, PU 1	ET 200SP, AQ 2xI Standard, PU 1	ET 200SP, AQ 4xU/I ST	ET 200SP, AQ 2 X U/I High Speed	ET 200SP, AQ 2 X U/I High Feature
Errors/accuracies					
Basic error limit (operational limit at 25 °C)					
• Voltage, relative to output range, (+/-)	0.3 %	0.3 %	0.3 %	0.1 %	0.1 %
• Current, relative to output range, (+/-)	0.3 %	0.3 %	0.3 %	0.1 %	0.1 %
Isochronous mode					
Execution and activation time (TCO), min.				70 µs	500 µs
Bus cycle time (TDP), min.				125 µs	750 µs
Interrupts/diagnostics/status information					
Diagnostics function	Yes	Yes	Yes	Yes	Yes
Substitute values connectable	Yes	Yes	Yes	Yes	Yes
Alarms					
• Diagnostic alarm	Yes	Yes	Yes	Yes	Yes
Diagnostic messages					
• Monitoring the supply voltage	Yes	Yes	Yes	Yes	Yes
• Wire-break		Yes	Yes	Yes; channel-by-channel, only for output type "current"	Yes; channel-by-channel, only for output type "current"
• Short-circuit	Yes		Yes	Yes; channel-by-channel, only for output type "voltage"	Yes; channel-by-channel, only for output type "voltage"
• Group error	Yes	Yes	Yes	Yes	Yes
• Overflow/underflow	Yes	Yes	Yes	Yes	Yes
Diagnostics indication LED					
• Monitoring of the supply voltage (PWR-LED)	Yes; green PWR LED	Yes; green PWR LED	Yes; green PWR LED	Yes; green PWR LED	Yes; green PWR LED
• Channel status display	Yes; green LED	Yes; green LED	Yes; green LED	Yes; green LED	Yes; green LED
• for channel diagnostics	No	No	No	Yes; red LED	Yes; red LED
• for module diagnostics	Yes; green/red DIAG LED	Yes; green/red DIAG LED	Yes; green/red DIAG LED	Yes; green/red DIAG LED	Yes; green/red DIAG LED
Potential separation					
Potential separation channels					
• between the channels and backplane bus	Yes	Yes	Yes	Yes	Yes
Ambient conditions					
Ambient temperature during operation					
• horizontal installation, min.	-30 °C	-30 °C	-30 °C	-30 °C	-30 °C
• horizontal installation, max.	60 °C	60 °C	60 °C; Observe derating	60 °C	60 °C
• vertical installation, min.	-30 °C	-30 °C	-30 °C	-30 °C	-30 °C
• vertical installation, max.	50 °C	50 °C	50 °C; Observe derating	50 °C	50 °C
Altitude during operation relating to sea level					
• Installation altitude above sea level, max.	2 000 m; On request: Installation altitudes greater than 2 000 m	2 000 m; On request: Installation altitudes greater than 2 000 m	2 000 m; On request: Installation altitudes greater than 2 000 m	2 000 m; On request: Installation altitudes greater than 2 000 m	2 000 m; On request: Installation altitudes greater than 2 000 m
Dimensions					
Width	15 mm	15 mm	15 mm	15 mm	15 mm
Height	73 mm	73 mm	73 mm	73 mm	73 mm
Depth	58 mm	58 mm	58 mm	58 mm	58 mm
Weights					
Weight, approx.	31 g	31 g	31 g	31 g	31 g

I/O systemsSIMATIC ET 200 systems for the control cabinet
SIMATIC ET 200SP**I/O modules > Analog output modules****Technical specifications**

Article number	6ES7135-6TD00-0CA1 ET 200SP, AQ 4xI HART HF
General information	
Product type designation	AQ 4xI HART HF
Product function	
• I&M data	Yes; I&M0 to I&M3
Engineering with	
• STEP 7 TIA Portal configurable/ integrated as of version	V15 SP1
• STEP 7 configurable/integrated as of version	V5.6 and higher
• PCS 7 configurable/integrated as of version	V9.0 SP1
• PROFIBUS as of GSD version/ GSD revision	V04.02.14
• PROFINET as of GSD version/ GSD revision	GSDML V2.34
Supply voltage	
Rated value (DC)	24 V
Reverse polarity protection	Yes
Analog outputs	
Number of analog outputs	4
Cycle time (all channels), min.	3 ms
Output ranges, current	
• 0 to 20 mA	Yes; 16 bit incl. sign
• -20 mA to +20 mA	No
• 4 mA to 20 mA	Yes; 16 bit incl. sign
Connection of actuators	
• for current output two-wire connection	Yes
Load impedance (in rated range of output)	
• with current outputs, max.	750 Ω
• with current outputs, inductive load, max.	10 mH
Cable length	
• shielded, max.	800 m
Settling time	
• for resistive load	2 ms; 750 ohm
• for capacitive load	2 ms
• for inductive load	2 ms
Errors/accuracies	
Basic error limit (operational limit at 25 °C)	
• Current, relative to output range, (+/-)	0.1 %
Protocols	
HART protocol	Yes

Article number	6ES7135-6TD00-0CA1 ET 200SP, AQ 4xI HART HF
Interrupts/diagnostics/ status information	
Diagnostics function	Yes
Substitute values connectable	Yes
Alarms	
• Diagnostic alarm	Yes
Diagnostic messages	
• Monitoring the supply voltage	Yes; Module-wise
• Wire-break	Yes; channel by channel
• Short-circuit	Yes
• Overflow/underflow	Yes; channel by channel
Diagnostics indication LED	
• Monitoring of the supply voltage (PWR-LED)	Yes; green PWR LED
• Channel status display	Yes; green LED
• for channel diagnostics	Yes; red LED
• for module diagnostics	Yes; green/red DIAG LED
Potential separation	
Potential separation channels	
• between the channels and backplane bus	Yes
Ambient conditions	
Ambient temperature during operation	
• horizontal installation, min.	-30 °C
• horizontal installation, max.	60 °C
• vertical installation, min.	-30 °C
• vertical installation, max.	50 °C
Altitude during operation relating to sea level	
• Installation altitude above sea level, max.	2 000 m; On request: Installation altitudes greater than 2 000 m
Dimensions	
Width	15 mm
Height	73 mm
Depth	58 mm
Weights	
Weight, approx.	31 g

Ordering data	Article No.	Article No.
Analog output modules		BU15-P16+A10+2B
Analog output module AQ 2xU Standard, BU type A0 or A1, color code CC00, 16-bit	6ES7135-6FB00-0BA1	BU type A0; BaseUnit (dark) with 16 process terminals (1 ... 16) to the module and an additional 10 internally jumpered AUX terminals (1 A to 10 A); for continuing the load group • 1 unit • 10 units
Analog output module AQ 2xl Standard, BU type A0 or A1, color code CC00, 16-bit	6ES7135-6GB00-0BA1	6ES7193-6BP20-0BA0 6ES7193-6BP20-2BA0
Analog output module AQ 4xU/I Standard, BU type A0 or A1, color code CC00, 16-bit, ± 0.3%	6ES7135-6HD00-0BA1	BU15-P16+A0+2B
Analog output module AQ 2xU/I High Feature, BU type A0 or A1, color code CC00, 16-bit, ±0.1%	6ES7135-6HB00-0CA1	BU type A0; BaseUnit (dark) with 16 process terminals to the module; for continuing the load group • 1 unit • 10 units
Analog output module AQ 2xU/I High Speed, BU type A0 or A1, color code CC00, 16-bit, ±0.3%	6ES7135-6HB00-0DA1	2BU15-P16+A0+2B
Analog output module AQ 4xl HART High Feature, BU type A0 or A1, color code CC00, 16-bit, ±0.3%	6ES7135-6TD00-0CA1	Double BaseUnit for holding 2 I/O modules; BU type A0; BaseUnit (dark/dark) with 16 push-in terminals to the module; for continuing the load group • 1 unit
Usable type A0 BaseUnits		Usable type A1 BaseUnits (temperature detection)
Type of delivery: Apart from the standard type of delivery in an individual package, selected BaseUnits are also available in a pack of 10 units. The pack of 10 units enables the amount of waste to be reduced considerably, as well as saving the time and cost of unpacking individual modules. The number of modules required is the number of modules ordered. The type of packaging is chosen by selecting the article number. Packs of 10 can therefore only be ordered in integer multiples of 10.		BU15-P16+A0+12D/T
		BU type A1; BaseUnit (light) with 16 push-in terminals (1 ... 16) to the module and 2x5 internally jumpered additional terminals (1 B to 5 B and 1 C to 5 C); for starting a new load group (max. 10 A)
		BU15-P16+A0+2D/T
		BU type A1; BaseUnit (light) with 16 process terminals to the module; for starting a new load group (max. 10 A)
BU15-P16+A10+2D		BU15-P16+A0+12B/T
BU type A0; BaseUnit (light) with 16 process terminals (1 ... 16) to the module and an additional 10 internally jumpered AUX terminals (1 A to 10 A); for starting a new load group (max. 10 A) • 1 unit • 10 units	6ES7193-6BP20-0DA0 6ES7193-6BP20-2DA0	BU type A1; BaseUnit (dark) with 16 process terminals (1 ... 16) to the module and 2x5 internally jumpered additional terminals (1 B to 5 B and 1 C to 5 C); for continuing the load group
BU15-P16+A0+2D		BU15-P16+A0+2B/T
BU type A0; BaseUnit (light) with 16 process terminals to the module; for starting a new load group (max. 10 A) • 1 unit • 10 units	6ES7193-6BP00-0DA0 6ES7193-6BP00-2DA0	BU type A1; BaseUnit (dark) with 16 process terminals to the module; for continuing the load group
2BU15-P16+A0+2DB		Potential distributor modules
Double BaseUnit for holding 2 I/O modules; BU type A0; BaseUnit (light/dark) with 16 process terminals to the module; for starting a new load group (max. 10 A) • 1 unit	6ES7193-6BP60-0DA0	PotDis BU
		PotDis BU, type P1 (light), 17x P1 potential, 1x P2 potential, for starting a new load group (max. 10 A)
		PotDis BU, type P1 (dark), 17x P1 potential, 1x P2 potential, for continuing the load group
		PotDis BU, type P2 (light), 1x P1 potential, 17x P2 potential, for starting a new load group (max. 10 A)
		PotDis BU, type P2 (dark), 1x P1 potential, 17x P2 potential, for continuing the load group

I/O systemsSIMATIC ET 200 systems for the control cabinet
SIMATIC ET 200SP**I/O modules > Analog output modules****Ordering data****Article No.****PotDis TB**

PotDis TB, type BR-W, 18x internally jumpered terminals, without reference to P1, P2 or AUX, (total current max. 10 A)

6ES7193-6TP00-0TP0

PotDis TB, type P1-R, 18x P1 potential, (total current max. 10 A)

6ES7193-6TP00-0TP1

PotDis TB, type P2-B, 18x P2 potential, (total current max. 10 A)

6ES7193-6TP00-0TP2

PotDis TB, type n.c.-G, 18x n.c. (not connected) terminals, without reference to P1, P2 or AUX

6ES7193-6TP00-0TN0**Accessories****Equipment labeling plates**

10 sheets of 16 plates, for printing with thermal transfer card printer or plotter

6ES7193-6LF30-0AW0**Labeling strips**

500 labeling strips on roll, light gray, for inscription with thermal transfer roll printer

6ES7193-6LR10-0AA0

500 labeling strips on roll, yellow, for inscription with thermal transfer roll printer

6ES7193-6LR10-0AG0

1 000 labeling strips DIN A4, light gray, card, perforated, for inscription with laser printer

6ES7193-6LA10-0AA0

1 000 labeling strips DIN A4, yellow, card, perforated, for inscription with laser printer

6ES7193-6LA10-0AG0**BU cover**

For covering empty slots (gaps); 5 units

- 15 mm
- 20 mm

6ES7133-6CV15-1AM0**6ES7133-6CV20-1AM0****Shield connection**

5 shield supports and 5 shield terminals

6ES7193-6SC00-1AM0**Article No.****Color-coded labels**

Color code CC00, for 16 push-in terminals, BU type A0, A1, gray (terminals 1 to 8), red (terminals 9 to 16); 10 units

6ES7193-6CP00-2MA0

Color code CC71, for 10 AUX terminals, BU type A0, yellow/green (terminals 1 A to 10 A); 10 units

6ES7193-6CP71-2AA0

Color code CC72, for 10 AUX terminals, BU type A0, red (terminals 1 A to 10 A); 10 units

6ES7193-6CP72-2AA0

Color code CC73, for 10 AUX terminals, BU type A0, blue (terminals 1 A to 10 A); 10 units

6ES7193-6CP73-2AA0

Color code CC74, for 2x5 additional terminals, BU type A1, red (terminals 1B to 5B), blue (terminals 1C to 5C); 10 units

6ES7193-6CP74-2AA0**Color-coded labels for PotDis BU**

Color code CC62, for 16 push-in terminals, PotDis BU type P1, red (terminals 1 to 16); 10 units

6ES7193-6CP62-2MA0

Color code CC63, for 16 push-in terminals, PotDis BU type P2, blue (terminals 1 to 16); 10 units

6ES7193-6CP63-2MA0**Color-coded labels for PotDis TB**

Color code CC10, for 18 push-in terminals, PotDis TB, gray (terminals 1 to 18); 10 units

6ES7193-6CP10-2MT0

Color code CC11, for 18 push-in terminals, PotDis TB, yellow-green (terminals 1 to 18); 10 units

6ES7193-6CP11-2MT0

Color code CC12, for 18 push-in terminals, PotDis TB, type P1 and BR, red (terminals 1 to 18); 10 units

6ES7193-6CP12-2MT0

Color code CC13, for 18 push-in terminals, PotDis TB, type P2 and BR, blue (terminals 1 to 18); 10 units

6ES7193-6CP13-2MT0

Overview



- 2, 4 and 8-channel AI modules
- Measuring ranges for current, voltage, thermocouples, resistance thermometer, resistor and PTC
- BaseUnits for 2, 3 and 4-conductor connection
- Function classes Basic, Standard, High Feature and High Speed
- Clear labeling on front of module
- LEDs for diagnostics, status and errors
- Individual system-integrated load group formation with self-assembling potential multi-terminal busbars (power module not required for ET 200SP)
- Electronically readable rating plate (I&M data)
- Additional operating modes in some cases
- Optional accessories:
 - Labeling strips
 - Equipment marking label
 - Color-coded label with module-specific CC code
 - Shielding terminal

Overview of SIPLUS analog input modules

Analog input	PU	Article No.	CC code	BU type
AI 8 x I 2/4-wire BA	1	6AG1134-6GF00-7AA1	CC01	A0, A1
AI 8 x U BA	1	6AG1134-6FF00-2AA1	CC02	A0, A1
AI 4 x U/I 2-wire ST	1	6AG1134-6HD01-7BA1	CC03	A0, A1
AI 4 x I 2/4-wire ST	1	6AG1134-6GD01-7BA1	CC03	A0, A1
AI 4 x I 2-wire 4 ... 20 mA HART	1	6AG1134-6TD00-2CA1	CC03	A0, A1
AI 2 x U/I 2/4-wire HF	1	6AG1134-6HB00-2CA1	CC05	A0, A1
AI 2xU/I 2/4-wire HS	1	6AG1134-6HB00-2DA1	CC00	A0, A1
With two operating modes: • High-speed isochronous AI • Oversampling				
AI 8 x RTD/TC 2-wire HF	1	6AG1134-6JF00-2CA1	CC00	A0, A1
AI 4 x RTD/TC 2/3/4-wire HF	1	6AG1134-6JD00-2CA1	CC00	A0, A1
AI Energy Meter 480 V AC ST	1	6AG1134-6PA20-7BD0	--	D0

Note:

SIPLUS extreme products are based on SIMATIC standard products. The contents listed here were adopted from the respective standard products. SIPLUS extreme-specific information was added.

I/O systemsSIMATIC ET 200 systems for the control cabinet
SIMATIC ET 200SP**I/O modules > SIPLUS analog inputs****Technical specifications**

Article number	6AG1134-6GF00-7AA1	6AG1134-6FF00-2AA1	6AG1134-6HD01-7BA1	6AG1134-6GD01-7BA1	6AG1134-6TD00-2CA1
Based on	6ES7134-6GF00-0AA1 SIPLUS ET 200SP AI 8xI 2-/4-WIRE BA	6ES7134-6FF00-0AA1 SIPLUS ET 200SP AI 8xU BASIC	6ES7134-6HD01-0BA1 SIPLUS ET 200SP AI 4xU/I 2-w ST	6ES7134-6GD01-0BA1 SIPLUS ET 200SP AI 4xI 2-/4-w ST	6ES7134-6TD00-0CA1 SIPLUS ET 200SP AI 4xI 2-WIRE 4...20MA H
Ambient conditions					
Ambient temperature during operation					
• horizontal installation, min.	-40 °C; = Tmin (incl. condensation/frost)	-40 °C; = Tmin (incl. condensation/frost)	-40 °C; = Tmin (incl. condensation/frost)	-40 °C; = Tmin (incl. condensation/frost)	-40 °C; = Tmin (incl. condensation/frost); start-up @ -25 °C
• horizontal installation, max.	70 °C; = Tmax	60 °C; = Tmax	70 °C; = Tmax; > 60 °C max. 1x ±20 mA or 4x ±10 V permissible	70 °C; = Tmax; > 60 °C max. 1x ±20 mA permissible	60 °C; = Tmax
• vertical installation, min.			-40 °C; = Tmin	-40 °C; = Tmin	-40 °C; = Tmin; Startup @ -25 °C
• vertical installation, max.			50 °C; = Tmax	50 °C; = Tmax	50 °C; = Tmax
Altitude during operation relating to sea level					
• Installation altitude above sea level, max.	5 000 m	5 000 m	5 000 m	5 000 m	5 000 m
• Ambient air temperature-barometric pressure-altitude	Tmin ... Tmax at 1 140 hPa ... 795 hPa (-1 000 m ... +2 000 m) // Tmin ... (Tmax - 10 K) at 795 hPa ... 658 hPa (+2 000 m ... +3 500 m) // Tmin ... (Tmax -20 K) at 658 hPa ... 540 hPa (+3 500 m ... +5 000 m)	Tmin ... Tmax at 1 140 hPa ... 795 hPa (-1 000 m ... +2 000 m) // Tmin ... (Tmax - 10 K) at 795 hPa ... 658 hPa (+2 000 m ... +3 500 m) // Tmin ... (Tmax -20 K) at 658 hPa ... 540 hPa (+3 500 m ... +5 000 m)	Tmin ... Tmax at 1 140 hPa ... 795 hPa (-1 000 m ... +2 000 m) // Tmin ... (Tmax - 10 K) at 795 hPa ... 658 hPa (+2 000 m ... +3 500 m) // Tmin ... (Tmax -20 K) at 658 hPa ... 540 hPa (+3 500 m ... +5 000 m)	Tmin ... Tmax at 1 140 hPa ... 795 hPa (-1 000 m ... +2 000 m) // Tmin ... (Tmax - 10 K) at 795 hPa ... 658 hPa (+2 000 m ... +3 500 m) // Tmin ... (Tmax -20 K) at 658 hPa ... 540 hPa (+3 500 m ... +5 000 m)	Tmin ... Tmax at 1 140 hPa ... 795 hPa (-1 000 m ... +2 000 m) // Tmin ... (Tmax - 10 K) at 795 hPa ... 658 hPa (+2 000 m ... +3 500 m) // Tmin ... (Tmax -20 K) at 658 hPa ... 540 hPa (+3 500 m ... +5 000 m)
Relative humidity					
• With condensation, tested in accordance with IEC 60068-2-38, max.	100 %; RH incl. condensation / frost (no commissioning in bedewed state), horizontal installation	100 %; RH incl. condensation / frost (no commissioning in bedewed state), horizontal installation	100 %; RH incl. condensation / frost (no commissioning in bedewed state), horizontal installation	100 %; RH incl. condensation / frost (no commissioning in bedewed state), horizontal installation	100 %; RH incl. condensation/frost (no commissioning under condensation conditions)
Resistance					
Coolants and lubricants					
- Resistant to commercially available coolants and lubricants	Yes; Incl. diesel and oil droplets in the air	Yes; Incl. diesel and oil droplets in the air	Yes; Incl. diesel and oil droplets in the air	Yes; Incl. diesel and oil droplets in the air	Yes; Incl. diesel and oil droplets in the air
Use in stationary industrial systems					
- to biologically active substances according to EN 60721-3-3	Yes; Class 3B2 mold, fungus and dry rot spores (with the exception of fauna); Class 3B3 on request	Yes; Class 3B2 mold, fungus and dry rot spores (with the exception of fauna); Class 3B3 on request	Yes; Class 3B2 mold, fungus and dry rot spores (with the exception of fauna); Class 3B3 on request	Yes; Class 3B2 mold, fungus and dry rot spores (with the exception of fauna); Class 3B3 on request	Yes; Class 3B2 mold, fungus and dry rot spores (with the exception of fauna); Class 3B3 on request
- to chemically active substances according to EN 60721-3-3	Yes; Class 3C4 (RH < 75 %) incl. salt spray acc. to EN 60068-2-52 (severity degree 3); *	Yes; Class 3C4 (RH < 75 %) incl. salt spray acc. to EN 60068-2-52 (severity degree 3); *	Yes; Class 3C4 (RH < 75 %) incl. salt spray acc. to EN 60068-2-52 (severity degree 3); *	Yes; Class 3C4 (RH < 75 %) incl. salt spray acc. to EN 60068-2-52 (severity degree 3); *	Yes; Class 3C4 (RH < 75 %) incl. salt spray acc. to EN 60068-2-52 (severity degree 3); *
- to mechanically active substances according to EN 60721-3-3	Yes; Class 3S4 incl. sand, dust, *	Yes; Class 3S4 incl. sand, dust, *	Yes; Class 3S4 incl. sand, dust, *	Yes; Class 3S4 incl. sand, dust, *	Yes; Class 3S4 incl. sand, dust, *
- Against mechanical environmental conditions acc. to EN 60721-3-3	Yes; Class 3M8 using the SIPLUS Mounting Kit ET 200SP (6AG1193-6AA00-0AA0)	Yes; Class 3M8 using the SIPLUS Mounting Kit ET 200SP (6AG1193-6AA00-0AA0)	Yes; Class 3M8 using the SIPLUS Mounting Kit ET 200SP (6AG1193-6AA00-0AA0)	Yes; Class 3M8 using the SIPLUS Mounting Kit ET 200SP (6AG1193-6AA00-0AA0)	Yes; Class 3M8 using the SIPLUS Mounting Kit ET 200SP (6AG1193-6AA00-0AA0)

Technical specifications

Article number	6AG1134-6GF00-7AA1	6AG1134-6FF00-2AA1	6AG1134-6HD01-7BA1	6AG1134-6GD01-7BA1	6AG1134-6TD00-2CA1
Based on	6ES7134-6GF00-0AA1 SIPLUS ET 200SP AI 8XI 2-/4-WIRE BA	6ES7134-6FF00-0AA1 SIPLUS ET 200SP AI 8xU BASIC	6ES7134-6HD01-0BA1 SIPLUS ET 200SP AI 4xU/I 2-w ST	6ES7134-6GD01-0BA1 SIPLUS ET 200SP AI 4xI 2-/4-w ST	6ES7134-6TD00-0CA1 SIPLUS ET 200SP AI 4xI 2-WIRE 4...20MA H
Use on ships/at sea					
- to biologically active substances according to EN 60721-3-6	Yes; Class 6B2 mold, fungal and dry rot spores (excluding fauna)	Yes; Class 6B2 mold and fungal spores (excluding fauna); Class 6B3 on request	Yes; Class 6B2 mold and fungal spores (excluding fauna); Class 6B3 on request	Yes; Class 6B2 mold and fungal spores (excluding fauna); Class 6B3 on request	Yes; Class 6B2 mold and fungal spores (excluding fauna); Class 6B3 on request
- to chemically active substances according to EN 60721-3-6	Yes; Class 6C3 (RH < 75 %) incl. salt spray acc. to EN 60068-2-52 (severity degree 3); *	Yes; Class 6C3 (RH < 75 %) incl. salt spray acc. to EN 60068-2-52 (severity degree 3); *	Yes; Class 6C3 (RH < 75 %) incl. salt spray acc. to EN 60068-2-52 (severity degree 3); *	Yes; Class 6C3 (RH < 75 %) incl. salt spray acc. to EN 60068-2-52 (severity degree 3); *	Yes; Class 6C3 (RH < 75 %) incl. salt spray acc. to EN 60068-2-52 (severity degree 3); *
- to mechanically active substances according to EN 60721-3-6	Yes; Class 6S3 incl. sand, dust; *	Yes; Class 6S3 incl. sand, dust; *	Yes; Class 6S3 incl. sand, dust; *	Yes; Class 6S3 incl. sand, dust; *	Yes; Class 6S3 incl. sand, dust; *
- Against mechanical environmental conditions acc. to EN 60721-3-6	Yes; Class 6M4 using the SIPLUS Mounting Kit ET 200SP (6AG1193-6AA00-0AA0)	Yes; Class 6M4 using the SIPLUS Mounting Kit ET 200SP (6AG1193-6AA00-0AA0)	Yes; Class 6M4 using the SIPLUS Mounting Kit ET 200SP (6AG1193-6AA00-0AA0)	Yes; Class 6M4 using the SIPLUS Mounting Kit ET 200SP (6AG1193-6AA00-0AA0)	Yes; Class 6M4 using the SIPLUS Mounting Kit ET 200SP (6AG1193-6AA00-0AA0)
Usage in industrial process technology					
- Against chemically active substances acc. to EN 60654-4	Yes; Class 3 (excluding trichlorethylene)	Yes; Class 3 (excluding trichlorethylene)	Yes; Class 3 (excluding trichlorethylene)	Yes; Class 3 (excluding trichlorethylene)	Yes; Class 3 (excluding trichlorethylene)
- Environmental conditions for process, measuring and control systems acc. to ANSI/ISA-71.04	Yes; Level GX group A/B (excluding trichlorethylene; harmful gas concentrations up to the limits of EN 60721-3-3 class 3C4 permissible); level LC3 (salt spray) and level LB3 (oil)	Yes; Level GX group A/B (excluding trichlorethylene; harmful gas concentrations up to the limits of EN 60721-3-3 class 3C4 permissible); level LC3 (salt spray) and level LB3 (oil)	Yes; Level GX group A/B (excluding trichlorethylene; harmful gas concentrations up to the limits of EN 60721-3-3 class 3C4 permissible); level LC3 (salt spray) and level LB3 (oil)	Yes; Level GX group A/B (excluding trichlorethylene; harmful gas concentrations up to the limits of EN 60721-3-3 class 3C4 permissible); level LC3 (salt spray) and level LB3 (oil)	Yes; Level GX group A/B (excluding trichlorethylene; harmful gas concentrations up to the limits of EN 60721-3-3 class 3C4 permissible); level LC3 (salt spray) and level LB3 (oil)
Remark					
- Note regarding classification of environmental conditions acc. to EN 60721, EN 60654-4 and ANSI/ISA-71.04	* The supplied plug covers must remain in place over the unused interfaces during operation!	* The supplied plug covers must remain in place over the unused interfaces during operation!	* The supplied plug covers must remain in place over the unused interfaces during operation!	* The supplied plug covers must remain in place over the unused interfaces during operation!	* The supplied plug covers must remain in place over the unused interfaces during operation!
Conformal coating					
• Coatings for printed circuit board assemblies acc. to EN 61086	Yes; Class 2 for high reliability	Yes; Class 2 for high reliability	Yes; Class 2 for high reliability	Yes; Class 2 for high reliability	Yes; Class 2 for high reliability
• Protection against fouling acc. to EN 60664-3	Yes; Type 1 protection	Yes; Type 1 protection	Yes; Type 1 protection	Yes; Type 1 protection	Yes; Type 1 protection
• Military testing according to MIL-I-46058C, Amendment 7	Yes; Discoloration of coating possible during service life	Yes; Discoloration of coating possible during service life	Yes; Discoloration of coating possible during service life	Yes; Discoloration of coating possible during service life	Yes; Discoloration of coating possible during service life
• Qualification and Performance of Electrical Insulating Compound for Printed Board Assemblies according to IPC-CC-830A	Yes; Conformal coating, Class A	Yes; Conformal coating, Class A	Yes; Conformal coating, Class A	Yes; Conformal coating, Class A	Yes; Conformal coating, Class A

I/O systems

SIMATIC ET 200 systems for the control cabinet
SIMATIC ET 200SP

I/O modules > SIPLUS analog inputs

Technical specifications

Article number	6AG1134-6HB00-2CA1	6AG1134-6HB00-2DA1	6AG1134-6JF00-2CA1	6AG1134-6JD00-2CA1
Based on	6ES7134-6HB00-0CA1 SIPLUS ET 200SP AI 2 X U/I 2-, 4-WIRE HF	6ES7134-6HB00-0DA1 SIPLUS ET 200SP AI 2 X U/I 2-, 4-WIRE HS	6ES7134-6JF00-0CA1 SIPLUS ET 200SP AI 8XRTD/TC 2-WIRE HF	6ES7134-6JD00-0CA1 SIPLUS ET 200SP AI 4XRTD/TC HF
Ambient conditions				
Ambient temperature during operation				
• horizontal installation, min.	-40 °C; = Tmin (incl. condensation/frost); start-up @ -25 °C	-40 °C; = Tmin (incl. condensation/frost); start-up @ -25 °C	-40 °C; = Tmin (incl. condensation/frost); start-up @ -25 °C	-40 °C; = Tmin (incl. condensation/frost); start-up @ -25 °C
• horizontal installation, max.	60 °C; = Tmax	60 °C; = Tmax	60 °C; = Tmax	60 °C; = Tmax
• vertical installation, min.			-40 °C; = Tmin; Startup @ -25 °C	-40 °C; = Tmin; Startup @ -25 °C
• vertical installation, max.			50 °C; = Tmax	50 °C; = Tmax
Altitude during operation relating to sea level				
• Installation altitude above sea level, max.	5 000 m	5 000 m	5 000 m	5 000 m
• Ambient air temperature-barometric pressure-altitude	Tmin ... Tmax at 1 140 hPa ... 795 hPa (-1 000 m ... +2 000 m) // Tmin ... (Tmax - 10 K) at 795 hPa ... 658 hPa (+2 000 m ... +3 500 m) // Tmin ... (Tmax -20 K) at 658 hPa ... 540 hPa (+3 500 m ... +5 000 m)	Tmin ... Tmax at 1 140 hPa ... 795 hPa (-1 000 m ... +2 000 m) // Tmin ... (Tmax - 10 K) at 795 hPa ... 658 hPa (+2 000 m ... +3 500 m) // Tmin ... (Tmax -20 K) at 658 hPa ... 540 hPa (+3 500 m ... +5 000 m)	Tmin ... Tmax at 1 140 hPa ... 795 hPa (-1 000 m ... +2 000 m) // Tmin ... (Tmax - 10 K) at 795 hPa ... 658 hPa (+2 000 m ... +3 500 m) // Tmin ... (Tmax -20 K) at 658 hPa ... 540 hPa (+3 500 m ... +5 000 m)	Tmin ... Tmax at 1 080 hPa ... 795 hPa (-1 000 m ... +2 000 m) // Tmin ... (Tmax - 10 K) at 795 hPa ... 658 hPa (+2 000 m ... +3 500 m) // Tmin ... (Tmax - 20 K) at 658 hPa ... 540 hPa (+3 500 m ... +5 000 m)
Relative humidity				
• With condensation, tested in accordance with IEC 60068-2-38, max.	100 %; RH incl. condensation / frost (no commissioning in bedewed state), horizontal installation	100 %; RH incl. condensation / frost (no commissioning in bedewed state), horizontal installation	100 %; RH incl. condensation/frost (no commissioning under condensation conditions)	100 %; RH incl. condensation/frost (no commissioning under condensation conditions)
Resistance				
Coolants and lubricants				
- Resistant to commercially available coolants and lubricants	Yes; Incl. diesel and oil droplets in the air	Yes; Incl. diesel and oil droplets in the air	Yes; Incl. diesel and oil droplets in the air	Yes; Incl. diesel and oil droplets in the air
Use in stationary industrial systems				
- to biologically active substances according to EN 60721-3-3	Yes; Class 3B2 mold, fungus and dry rot spores (with the exception of fauna); Class 3B3 on request	Yes; Class 3B2 mold, fungus and dry rot spores (with the exception of fauna); Class 3B3 on request	Yes; Class 3B2 mold, fungus and dry rot spores (with the exception of fauna); Class 3B3 on request	Yes; Class 3B2 mold, fungus and dry rot spores (with the exception of fauna); Class 3B3 on request
- to chemically active substances according to EN 60721-3-3	Yes; Class 3C4 (RH < 75 %) incl. salt spray acc. to EN 60068-2-52 (severity degree 3); *	Yes; Class 3C4 (RH < 75 %) incl. salt spray acc. to EN 60068-2-52 (severity degree 3); *	Yes; Class 3C4 (RH < 75 %) incl. salt spray acc. to EN 60068-2-52 (severity degree 3); *	Yes; Class 3C4 (RH < 75 %) incl. salt spray acc. to EN 60068-2-52 (severity degree 3); *
- to mechanically active substances according to EN 60721-3-3	Yes; Class 3S4 incl. sand, dust; *	Yes; Class 3S4 incl. sand, dust; *	Yes; Class 3S4 incl. sand, dust; *	Yes; Class 3S4 incl. sand, dust; *
- Against mechanical environmental conditions acc. to EN 60721-3-3	Yes; Class 3M8 using the SIPLUS Mounting Kit ET 200SP (6AG1193-6AA00-0AA0)	Yes; Class 3M8 using the SIPLUS Mounting Kit ET 200SP (6AG1193-6AA00-0AA0)	Yes; Class 3M8 using the SIPLUS Mounting Kit ET 200SP (6AG1193-6AA00-0AA0)	Yes; Class 3M8 using the SIPLUS Mounting Kit ET 200SP (6AG1193-6AA00-0AA0)
Use on ships/at sea				
- to biologically active substances according to EN 60721-3-6	Yes; Class 6B2 mold and fungal spores (excluding fauna); Class 6B3 on request	Yes; Class 6B2 mold and fungal spores (excluding fauna); Class 6B3 on request	Yes; Class 6B2 mold and fungal spores (excluding fauna); Class 6B3 on request	Yes; Class 6B2 mold and fungal spores (excluding fauna); Class 6B3 on request
- to chemically active substances according to EN 60721-3-6	Yes; Class 6C3 (RH < 75 %) incl. salt spray acc. to EN 60068-2-52 (severity degree 3); *	Yes; Class 6C3 (RH < 75 %) incl. salt spray acc. to EN 60068-2-52 (severity degree 3); *	Yes; Class 6C3 (RH < 75 %) incl. salt spray acc. to EN 60068-2-52 (severity degree 3); *	Yes; Class 6C3 (RH < 75 %) incl. salt spray acc. to EN 60068-2-52 (severity degree 3); *
- to mechanically active substances according to EN 60721-3-6	Yes; Class 6S3 incl. sand, dust; *	Yes; Class 6S3 incl. sand, dust; *	Yes; Class 6S3 incl. sand, dust; *	Yes; Class 6S3 incl. sand, dust; *
- Against mechanical environmental conditions acc. to EN 60721-3-6	Yes; Class 6M4 using the SIPLUS Mounting Kit ET 200SP (6AG1193-6AA00-0AA0)	Yes; Class 6M4 using the SIPLUS Mounting Kit ET 200SP (6AG1193-6AA00-0AA0)	Yes; Class 6M4 using the SIPLUS Mounting Kit ET 200SP (6AG1193-6AA00-0AA0)	Yes; Class 6M4 using the SIPLUS Mounting Kit ET 200SP (6AG1193-6AA00-0AA0)

Technical specifications

Article number	6AG1134-6HB00-2CA1	6AG1134-6HB00-2DA1	6AG1134-6JF00-2CA1	6AG1134-6JD00-2CA1
Based on	6ES7134-6HB00-0CA1 SIPLUS ET 200SP AI 2 X U/I 2-, 4-WIRE HF	6ES7134-6HB00-0DA1 SIPLUS ET 200SP AI 2 X U/I 2-, 4-WIRE HS	6ES7134-6JF00-0CA1 SIPLUS ET 200SP AI 8XRTD/TC 2-WIRE HF	6ES7134-6JD00-0CA1 SIPLUS ET 200SP AI 4xRTD/TC HF
Usage in industrial process technology				
- Against chemically active substances acc. to EN 60654-4	Yes; Class 3 (excluding trichlorethylene)	Yes; Class 3 (excluding trichlorethylene)	Yes; Class 3 (excluding trichlorethylene)	Yes; Class 3 (excluding trichlorethylene)
- Environmental conditions for process, measuring and control systems acc. to ANSI/ISA-71.04	Yes; Level GX group A/B (excluding trichlorethylene; harmful gas concentrations up to the limits of EN 60721-3-3 class 3C4 permissible); level LC3 (salt spray) and level LB3 (oil)	Yes; Level GX group A/B (excluding trichlorethylene; harmful gas concentrations up to the limits of EN 60721-3-3 class 3C4 permissible); level LC3 (salt spray) and level LB3 (oil)	Yes; Level GX group A/B (excluding trichlorethylene; harmful gas concentrations up to the limits of EN 60721-3-3 class 3C4 permissible); level LC3 (salt spray) and level LB3 (oil)	Yes; Level GX group A/B (excluding trichlorethylene; harmful gas concentrations up to the limits of EN 60721-3-3 class 3C4 permissible); level LC3 (salt spray) and level LB3 (oil)
Remark				
- Note regarding classification of environmental conditions acc. to EN 60721, EN 60654-4 and ANSI/ISA-71.04	* The supplied plug covers must remain in place over the unused interfaces during operation!	* The supplied plug covers must remain in place over the unused interfaces during operation!	* The supplied plug covers must remain in place over the unused interfaces during operation!	* The supplied plug covers must remain in place over the unused interfaces during operation!
Conformal coating				
• Coatings for printed circuit board assemblies acc. to EN 61086	Yes; Class 2 for high reliability	Yes; Class 2 for high availability	Yes; Class 2 for high reliability	Yes; Class 2 for high reliability
• Protection against fouling acc. to EN 60664-3	Yes; Type 1 protection	Yes; Type 1 protection	Yes; Type 1 protection	Yes; Type 1 protection
• Military testing according to MIL-I-46058C, Amendment 7	Yes; Discoloration of coating possible during service life	Yes; Discoloration of coating possible during service life	Yes; Discoloration of coating possible during service life	Yes; Discoloration of coating possible during service life
• Qualification and Performance of Electrical Insulating Compound for Printed Board Assemblies according to IPC-CC-830A	Yes; Conformal coating, Class A	Yes; Conformal coating, Class A	Yes; Conformal coating, Class A	Yes; Conformal coating, Class A
Article number	6AG1134-6PA20-7BD0	Article number	6AG1134-6PA20-7BD0	
Based on	6ES7134-6PA20-0BD0 SIPLUS ET 200SP AI EMETER 480VAC ST	Based on	6ES7134-6PA20-0BD0 SIPLUS ET 200SP AI EMETER 480VAC ST	
Ambient conditions		Use in stationary industrial systems		
Ambient temperature during operation		- to biologically active substances according to EN 60721-3-3	Yes; Class 3B2 mold, fungus and dry rot spores (with the exception of fauna); Class 3B3 on request	
• horizontal installation, min.	-40 °C; = Tmin; < -25 °C min. permissible supply voltage 110 V AC	- to chemically active substances according to EN 60721-3-3	Yes; Class 3C4 (RH < 75 %) incl. salt spray acc. to EN 60068-2-52 (severity degree 3); *	
• horizontal installation, max.	70 °C; = Tmax; > +60 °C max. permissible current 1 A per phase	- to mechanically active substances according to EN 60721-3-3	Yes; Class 3S4 incl. sand, dust, *	
• vertical installation, min.	-40 °C; = Tmin	- Against mechanical environmental conditions acc. to EN 60721-3-3	Yes; Class 3M8 using the SIPLUS Mounting Kit ET 200SP (6AG1193-6AA00-0AA0)	
• vertical installation, max.	50 °C; = Tmax			
Altitude during operation relating to sea level		Use on ships/at sea		
• Installation altitude above sea level, max.	2 000 m	- to biologically active substances according to EN 60721-3-6	Yes; Class 6B2 mold and fungal spores (excluding fauna); Class 6B3 on request	
• Ambient air temperature-barometric pressure-altitude	Tmin ... Tmax at 1 140 hPa ... 795 hPa (-1 000 m ... +2 000 m)	- to chemically active substances according to EN 60721-3-6	Yes; Class 6C3 (RH < 75 %) incl. salt spray acc. to EN 60068-2-52 (severity degree 3); *	
Relative humidity		- to mechanically active substances according to EN 60721-3-6	Yes; Class 6S3 incl. sand, dust; *	
• With condensation, tested in accordance with IEC 60068-2-38, max.	100 %; RH incl. condensation/frost (no commissioning under condensation conditions)	- Against mechanical environmental conditions acc. to EN 60721-3-6	Yes; Class 6M4 using the SIPLUS Mounting Kit ET 200SP (6AG1193-6AA00-0AA0)	
Resistance				
Coolants and lubricants				
- Resistant to commercially available coolants and lubricants	Yes; Incl. diesel and oil droplets in the air			

I/O systems

SIMATIC ET 200 systems for the control cabinet
SIMATIC ET 200SP

I/O modules > SIPLUS analog inputs

Technical specifications

Article number	6AG1134-6PA20-7BD0	Article number	6AG1134-6PA20-7BD0
Based on	6ES7134-6PA20-0BD0 SIPLUS ET 200SP AI EMETER 480VAC ST	Based on	6ES7134-6PA20-0BD0 SIPLUS ET 200SP AI EMETER 480VAC ST
Usage in industrial process technology	<p>Yes; Class 3 (excluding trichlorethylene)</p> <p>Yes; Level GX group A/B (excluding trichlorethylene; harmful gas concentrations up to the limits of EN 60721-3-3 class 3C4 permissible); level LC3 (salt spray) and level LB3 (oil)</p>	Conformal coating	<p>Yes; Class 2 for high availability</p> <p>Yes; Type 1 protection</p> <p>Yes; Discoloration of coating possible during service life</p> <p>Yes; Conformal coating, Class A</p>
Remark	<p>* The supplied plug covers must remain in place over the unused interfaces during operation!</p>	<ul style="list-style-type: none"> Coatings for printed circuit board assemblies acc. to EN 61086 Protection against fouling acc. to EN 60664-3 Military testing according to MIL-I-46058C, Amendment 7 Qualification and Performance of Electrical Insulating Compound for Printed Board Assemblies according to IPC-CC-830A 	

Ordering data

Ordering data	Article No.	Ordering data	Article No.
SIPLUS analog input modules (Extended temperature range and exposure to media)		Analog input module AI 2xU/I 2-/4-wire High Speed, BU type A0 or A1, color code CC00, 16-bit, ±0.3%, isochronous mode above 250 µs, oversampling above 50 µs	6AG1134-6HB00-2DA1
Analog input module AI 8xI 2/4-wire BA, BU type A0 or A1, color code CC01	6AG1134-6GF00-7AA1	Analog input module AI 8xRTD/TC 2-wire High Feature, BU type A0 or A1, color code CC00, 16-bit, ±0.1%, scalable measuring range	6AG1134-6JF00-2CA1
Analog input module AI 8xU BA, BU type A0 or A1, color code CC02	6AG1134-6FF00-2AA1	Analog input module AI Energy Meter Standard, 480 V AC, BU type D0	6AG1134-6PA20-7BD0
Analog input module AI 4xU/I 2-wire Standard, BU type A0 or A1, color code CC03, 16-bit, ±0.3%	6AG1134-6HD01-7BA1	Usable SIPLUS BaseUnits type A0	
Analog input module AI 4xI 2-/4-wire Standard, BU type A0 or A1, color code CC03, 16-bit, ±0.3%	6AG1134-6GD01-7BA1	BU15-P16+A0+2D (Extended temperature range and exposure to media) BU type A0; BaseUnit (light) with 16 process terminals to the module; for starting a new load group (max. 10 A)	6AG1193-6BP00-7DA0
Analog input module AI 4xRTD/TC 2-, 3-, 4-wire High Feature, BU type A0 or A1, color code CC00, 16-bit, ±0.1%, scalable measuring range	6AG1134-6JD00-2CA1	BU15-P16+A0+2B (Extended temperature range and exposure to media) BU type A0; BaseUnit (dark) with 16 process terminals to the module; for continuing the load group	6AG1193-6BP00-7BA0
Analog input module AI 4xI 2-wire 4 ... 20 mA HART, BU type A0 or A1, color code CC03	6AG1134-6TD00-2CA1	BU15-P16+A10+2D (Extended temperature range and exposure to media) BU type A0; BaseUnit (light) with 16 process terminals (1...16) to the module and an additional 10 internally jumpered AUX terminals (1 A to 10 A); for starting a new load group (max. 10 A)	6AG1193-6BP20-7DA0
Analog input module AI 2xU/I 2/4-wire High Feature, BU type A0 or A1, color code CC05, 16-bit, ±0.1%, independent channel isolation, isochronous mode above 1 ms	6AG1134-6HB00-2CA1		

Ordering data	Article No.	Ordering data	Article No.
<p>BU15-P16+A10+2B</p> <p>(Extended temperature range and exposure to media)</p> <p>BU type A0; BaseUnit (dark) with 16 process terminals (1...16) to the module and an additional 10 internally jumpered AUX terminals (1 A to 10 A); for continuing the load group</p>	6AG1193-6BP20-7BA0	<p>BU15-P16+A0+12D/T</p> <p>(Extended temperature range and exposure to media)</p> <p>BU type A1; BaseUnit (light) with 16 process terminals (1...16) to the module and 2x5 internally jumpered additional terminals (1 B to 5 B and 1 C to 5 C); for starting a new load group (max. 10 A)</p>	6AG1193-6BP40-7DA1
<p>Usable SIPLUS BaseUnits type A1 (temperature detection)</p>		<p>BU15-P16+A0+12B/T</p> <p>(Extended temperature range and exposure to media)</p> <p>BU type A1; BaseUnit (dark) with 16 process terminals (1...16) to the module and 2x5 internally jumpered additional terminals (1 B to 5 B and 1 C to 5 C); for continuing the load group</p>	6AG1193-6BP40-7BA1
<p>BU15-P16+A0+2D/T</p> <p>(Extended temperature range and exposure to media)</p> <p>BU type A1; BaseUnit (light) with 16 process terminals to the module; for starting a new load group (max. 10 A)</p>	6AG1193-6BP00-7DA1	<p>Usable SIPLUS BaseUnits type D0</p>	
<p>BU15-P16+A0+2B/T</p> <p>(Extended temperature range and exposure to media)</p> <p>BU type A1; BaseUnit (dark) with 16 process terminals to the module; for continuing the load group</p>	6AG1193-6BP00-7BA1	<p>BU20-P12+A0+0B</p> <p>(Extended temperature range and exposure to media)</p> <p>BU type D0; BaseUnit with 12 push-in terminals, without AUX terminals, bridged to the left</p>	6AG1193-6BP00-7BD0
		<p>Accessories</p>	See SIMATIC ET 200SP, analog input modules, catalog ST 70 · 2019, page 9/61

I/O systems

SIMATIC ET 200 systems for the control cabinet
SIMATIC ET 200SP

I/O modules > Technology modules > TM Count 1x24V counter module

Overview



- Counting frequency 200 kHz (800 kHz with quadruple evaluation)
- Counting range: +/- 31 bits
- Measurement function
- Parameterizable hardware interrupts
- Parameterizable input filters for suppressing interferences at sensor and digital inputs

Supported types of encoders/signals

- 24 V incremental encoder with and without N signal
- 24 V pulse encoder with direction signal
- 24 V pulse encoder without direction signal
- 24 V pulse encoder for pulse up and down respectively

Supported system functions

- Isochronous mode
- Firmware update
- Identification data I&M

Technical properties

- Counter module for ET 200SP
- Interfaces:
 - 24 V encoder signals A, B and N from P, M or push-pull-switching encoders and sensors
 - 24 V encoder supply output, short-circuit proof
 - 3 digital inputs for controlling the count operation, for saving or for setting the count value
 - 2 digital outputs for fast reactions regardless of the counter status or measured value

Technical specifications

Article number	6ES7138-6AA00-0BA0 ET 200SP, TM Count 1x24V
General information	
Product type designation	TM Count 1x24V
Product function	
• I&M data	Yes; I&M0 to I&M3
Engineering with	
• STEP 7 TIA Portal configurable/integrated as of version	V13 (FW V1.0), V14 (V1.2), V15 (FW V1.3) / V13 (FW V1.0), V14 SP1 (V1.2)
• STEP 7 configurable/integrated as of version	As of V5.5 SP3, only up to FW V1.2
• PROFIBUS as of GSD version/GSD revision	GSD Revision 5
• PROFINET as of GSD version/GSD revision	GSDML V2.3
Supply voltage	
Load voltage L+	
• Rated value (DC)	24 V
• Reverse polarity protection	Yes
Encoder supply	
Number of outputs	1
24 V encoder supply	
• 24 V	Yes; L+ (-0.8 V)
• Short-circuit protection	Yes; electronic/thermal
• Output current, max.	300 mA
Digital inputs	
Number of digital inputs	3
Digital inputs, parameterizable	Yes
Input characteristic curve in accordance with IEC 61131, type 3	Yes

Article number	6ES7138-6AA00-0BA0 ET 200SP, TM Count 1x24V
Digital input functions, parameterizable	
• Gate start/stop	Yes
• Capture	Yes
• Synchronization	Yes
• Freely usable digital input	Yes
Input voltage	
• Rated value (DC)	24 V
• for signal "0"	-5 ... +5 V
• for signal "1"	+11 to +30V
• permissible voltage at input, min.	-30 V; -5 V continuous, -30 V brief reverse polarity protection
• permissible voltage at input, max.	30 V
Input current	
• for signal "1", typ.	2.5 mA
Input delay (for rated value of input voltage) for standard inputs	
- parameterizable	Yes; none / 0.05 / 0.1 / 0.4 / 0.8 / 1.6 / 3.2 / 12.8 / 20 ms
- at "0" to "1", min.	6 µs; for parameterization "none"
- at "1" to "0", min.	6 µs; for parameterization "none"
for technological functions	
- parameterizable	Yes
Cable length	
• shielded, max.	1 000 m
• unshielded, max.	600 m

Technical specifications

Article number	6ES7138-6AA00-0BA0 ET 200SP, TM Count 1x24V
Digital outputs	
Type of digital output	Transistor
Number of digital outputs	2
Digital outputs, parameterizable	Yes
Short-circuit protection	Yes; electronic/thermal
Limitation of inductive shutdown voltage to	L+ (-33 V)
Controlling a digital input	Yes
Digital output functions, parameterizable	
• Switching tripped by comparison values	Yes
• Freely usable digital output	Yes
Switching capacity of the outputs	
• with resistive load, max.	0.5 A; Per digital output
• on lamp load, max.	5 W
Load resistance range	
• lower limit	48 Ω
• upper limit	12 kΩ
Output voltage	
• for signal "1", min.	23.2 V; L+ (-0.8 V)
Output current	
• for signal "1" rated value	0.5 A; Per digital output
• for signal "0" residual current, max.	0.5 mA
Output delay with resistive load	
• "0" to "1", max.	50 μs
• "1" to "0", max.	50 μs
Switching frequency	
• with resistive load, max.	10 kHz
• with inductive load, max.	0.5 Hz; Acc. to IEC 60947-5-1, DC-13; observe derating curve
• on lamp load, max.	10 Hz
Total current of the outputs	
• Current per module, max.	1 A
Cable length	
• shielded, max.	1 000 m
• unshielded, max.	600 m
Encoder	
Connectable encoders	
• 2-wire sensor	Yes
- permissible quiescent current (2-wire sensor), max.	1.5 mA
Encoder signals, incremental encoder (asymmetrical)	
• Input voltage	24 V
• Input frequency, max.	200 kHz
• Counting frequency, max.	800 kHz; with quadruple evaluation
• Cable length, shielded, max.	600 m; depending on input frequency, encoder and cable quality; max. 50 m at 200 kHz
• Signal filter, parameterizable	Yes
• Incremental encoder with A/B tracks, 90° phase offset	Yes
• Incremental encoder with A/B tracks, 90° phase offset and zero track	Yes
• Pulse encoder	Yes
• Pulse encoder with direction	Yes
• Pulse encoder with one impulse signal per count direction	Yes

Article number	6ES7138-6AA00-0BA0 ET 200SP, TM Count 1x24V
Encoder signal 24 V	
- permissible voltage at input, min.	-30 V
- permissible voltage at input, max.	30 V
Interface types	
• Source/sink input	Yes
• Input characteristic curve in accordance with IEC 61131, type 3	Yes
Interrupts/diagnostics/status information	
Substitute values connectable	Yes; Parameterizable
Alarms	
• Diagnostic alarm	Yes
• Hardware interrupt	Yes
Diagnostic messages	
• Monitoring the supply voltage	Yes
• Wire-break	Yes
• Short-circuit	Yes
• A/B transition error at incremental encoder	Yes
• Group error	Yes
Diagnostics indication LED	
• Monitoring of the supply voltage (PWR-LED)	Yes; green PWR LED
• Channel status display	Yes; green LED
• for module diagnostics	Yes; green/red DIAG LED
• Status indicator forward counting (green)	Yes
• Status indicator backward counting (green)	Yes
Integrated Functions	
Number of counters	1
Counting frequency (counter) max.	800 kHz; with quadruple evaluation
Fast mode	Yes; FW V1.2 or higher
Counting functions	
• Can be used with TO High_Speed_Counter	Yes
• Continuous counting	Yes
• Counter response parameterizable	Yes
• Hardware gate via digital input	Yes
• Software gate	Yes
• Event-controlled stop	Yes
• Synchronization via digital input	Yes
• Counting range, parameterizable	Yes
Comparator	
- Number of comparators	2
- Direction dependency	Yes
- Can be changed from user program	Yes
Position detection	
• Incremental acquisition	Yes
• Suitable for S7-1500 Motion Control	Yes
Measuring functions	
• Measuring time, parameterizable	Yes
• Dynamic measurement period adjustment	Yes
• Number of thresholds, parameterizable	2

I/O systems

SIMATIC ET 200 systems for the control cabinet
SIMATIC ET 200SP

I/O modules > Technology modules > TM Count 1x24V counter module

Technical specifications

Article number	6ES7138-6AA00-0BA0 ET 200SP, TM Count 1x24V
Measuring range	
- Frequency measurement, min.	0.04 Hz
- Frequency measurement, max.	800 kHz
- Cycle duration measurement, min.	1.25 µs
- Cycle duration measurement, max.	25 s
Accuracy	
- Frequency measurement	100 ppm; depending on measuring interval and signal evaluation
- Cycle duration measurement	100 ppm; depending on measuring interval and signal evaluation
- Velocity measurement	100 ppm; depending on measuring interval and signal evaluation
Potential separation	
Potential separation channels	Yes
• between the channels and backplane bus	

Article number	6ES7138-6AA00-0BA0 ET 200SP, TM Count 1x24V
Ambient conditions	
Ambient temperature during operation	
• horizontal installation, min.	-30 °C
• horizontal installation, max.	60 °C
• vertical installation, min.	-30 °C
• vertical installation, max.	50 °C
Decentralized operation	
to SIMATIC S7-300	Yes
to SIMATIC S7-400	Yes
to SIMATIC S7-1200	Yes
to SIMATIC S7-1500	Yes
to standard PROFIBUS master	Yes
to standard PROFINET controller	Yes
Dimensions	
Width	15 mm
Height	73 mm
Depth	58 mm
Weights	
Weight, approx.	45 g

10

Ordering data

Ordering data	Article No.
TM Count 1x24V counter module With one channel, max. 200 kHz; for 24 V encoder • 1 unit • 10 units	6ES7138-6AA01-0BA0 6ES7138-6AA01-2BA0
Suitable BaseUnits	
BU15-P16+A10+2D BU type A0; BaseUnit (light) with 16 push-in terminals (1 ... 16) to the module and an additional 10 internally jumpered AUX terminals (1 A to 10 A); for starting a new load group (max. 10 A) • 1 unit • 10 units	6ES7193-6BP20-0DA0 6ES7193-6BP20-2DA0
BU15-P16+A0+2D BU type A0; BaseUnit (light) with 16 push-in terminals to the module; for starting a new load group (max. 10 A) • 1 unit • 10 units	6ES7193-6BP00-0DA0 6ES7193-6BP00-2DA0
2BU15-P16+A0+2DB Double BaseUnit for holding 2 I/O modules; BU type A0; BaseUnit (light/dark) with 16 push-in terminals to the module; for starting a new load group (max. 10 A) • 1 unit	6ES7193-6BP60-0DA0

Article No.

BU15-P16+A10+2B BU type A0; BaseUnit (dark) with 16 push-in terminals (1 ... 16) to the module and an additional 10 internally jumpered AUX terminals (1 A to 10 A); for continuing the load group • 1 unit • 10 units	6ES7193-6BP20-0BA0 6ES7193-6BP20-2BA0
BU15-P16+A0+2B BU type A0; BaseUnit (dark) with 16 push-in terminals to the module; for continuing the load group • 1 unit • 10 units	6ES7193-6BP00-0BA0 6ES7193-6BP00-2BA0
2BU15-P16+A0+2B Double BaseUnit for holding 2 I/O modules; BU type A0; BaseUnit (dark/dark) with 16 push-in terminals to the module; for continuing the load group • 1 unit	6ES7193-6BP60-0BA0
Accessories	
Equipment labeling plates 10 sheets of 16 labels	6ES7193-6LF30-0AW0

Ordering data	Article No.	Ordering data	Article No.
Labeling strips 500 labeling strips on roll, light gray, for inscription with thermal transfer roll printer 500 labeling strips on roll, yellow, for inscription with thermal transfer roll printer 1000 labeling strips DIN A4, light gray, card, for inscription with laser printer 1000 labeling strips DIN A4, yellow, card, for inscription with laser printer	6ES7193-6LR10-0AA0 6ES7193-6LR10-0AG0 6ES7193-6LA10-0AA0 6ES7193-6LA10-0AG0	Shield connection 5 shield supports and 5 shield terminals Color-coded labels <ul style="list-style-type: none"> Color code CC71, for 10 AUX terminals 1 A to 10 A, for BU type A0, yellow/green, with push-in terminals; 10 units Color code CC72, for 10 AUX terminals 1 A to 10 A, for BU type A0, red, with push-in terminals; 10 units Color code CC73, for 10 AUX terminals 1 A to 10 A, for BU type A0, blue, with push-in terminals; 10 units 	6ES7193-6SC00-1AM0 6ES7193-6CP71-2AA0 6ES7193-6CP72-2AA0 6ES7193-6CP73-2AA0
BU cover For covering empty slots (gaps); 5 units <ul style="list-style-type: none"> 15 mm wide 20 mm wide 	6ES7133-6CV15-1AM0 6ES7133-6CV20-1AM0		

I/O systems

SIMATIC ET 200 systems for the control cabinet
SIMATIC ET 200SP

I/O modules > Technology modules > SIWAREX WP351

Overview



The SIWAREX WP351 is a compact, precise weighing module in the SIMATIC ET 200SP format.

With a width of just 20 mm it is one of the slimmest weighing modules on the market, yet its firmware includes the functionalities of an automatic totalizing weighing instrument and checking, bagging and filling scale.

All operating modes are part of the firmware and certified according to OIML R-51, R-61, R-76 and R-101¹⁾. This means the WP351 can be used in both scales requiring official calibration and those that do not, where demands are high regarding speed and accuracy.

¹⁾ Certificates in preparation

Technical specifications

SIWAREX WP351	
Firmware version	V1.0
• FW update possible	Yes
Usable BaseUnits	BU type U0
Reliability	
Mean time between failures (MTBF)	62 years @ TA = 40 °C
Product function	
I&M data	Yes, I&M0 to I&M3
Engineering with	
• STEP 7 TIA Portal can be configured/integrated	Configurable as of V15 using HSP0281
• PROFIBUS as of GSD version/GSD revision	GSD V04.02.41
• PROFINET as of GSD version/GSD revision	GSDML V2.34
Supply voltage	
Load voltage L+	
• Rated value (DC)	24 V
• Permissible range, low limit, static (DC)	19.2 V
• Permissible range, high limit, static (DC)	28.8 V
• Permissible range, low limit, dynamic (DC)	18.5 V
• Permissible range, high limit, dynamic (DC)	30.2 V
• Reverse polarity protection	Yes
• Non-periodic overvoltages	35 V DC for 500 ms with a recovery time of 50 s
Input current	
Current consumption, max.	Max. 140 mA @ 24 V DC + [DQ 3 × 0.5 A]
Power loss	
Typical power loss	1.7 W
Address range	
Assigned address range	
• Inputs	32 bytes
• Outputs	32 bytes
Power supply from SIMATIC S7 backplane bus	
Current consumption from ET 200SP backplane bus	Max. 27 mA @ 3.5 V (SBK4)

SIWAREX WP351	
Analog load cell interface connection	
Error limit according to DIN 1319-1 at 20 °C (-4 °F) +/-10 K	≤ 0.002% v.E.
Relative accuracy (absolute accuracy can only be achieved with local calibration using calibration standards)	
Measuring accuracy in accordance with OIML R76-1:2006/EN 45501:2015	
• Class	III
• Resolution (d=e)	3 x 6000 d
• Error percentage pi	0.4
• Step voltage	0.5 μV/e
Accuracy delivery state	Typ. 0.1% v.E.
The accuracy is relevant for module exchange or theoretical adjustment	
Sampling rate	1.024 ms
Input signal resolution	± 20 000 000
Measuring ranges	0 ... ±1 mV/V 0 ... ±2 mV/V 0 ... ±4 mV/V
Common mode voltage range	+2.8 ... 7.7 V
Strain gauge supply (constant voltage)	10 V DC (+1 % / -3 %) at the EXC terminals
Short-circuit and overload protection	Yes
Connection	6-wire or 4-wire (parameterizable)
Sensor voltage monitoring	Typ. ≤ 5.0 V
Min. strain gauge input resistance per channel	
• Without SIWAREX IS Ex-i interface	56 Ω
• With SIWAREX IS Ex-i interface	Lower impedance by means of external supply possible 87 Ω @ type 7MH4710-5BA 180 Ω @ type 7MH4710-5CA
Max. strain gauge resistance	4 100 Ω
Temperature coefficient range	≤ ±5 ppm/K
Temperature coefficient zero point	≤ ±0.015 μV/K
Linearity error	≤ 0.001%

Technical specifications

SIWAREX WP351	
Measured value filtering	Low-pass and average value filter configurable (DR3)
Galvanic isolation	500 V AC
50 Hz / 60 Hz noise suppression CMRR	> 80 dB
Input resistance	
• Signal line	Typ. $8 \times 10^6 \Omega$
• Sense line	Typ. $300 \times 10^6 \Omega$
Cable length	
• When using SIWAREX cable 7MH4702-8AG	Max. 500 m

SIWAREX WP351	
Ambient conditions	
Ambient temperature in operation	
• Horizontal mounting position *	Min. -30 °C Max. +60 °C
• Vertical mounting position *	Min. -30 °C Max. +50 °C
Storage and transport temperature	-40 ... +70 °C (-40 ... +158 °F)

* At a height of more than 2 000 meters above sea level, a derating of the ambient temperature of -1°C / 100 m has to be adhered to. The maximum permissible height is 5 000 meters above sea level. At over 0.6 A total current of the digital outputs DQ, a derating of the ambient temperature of -1°C per 100 mA has to be adhered to. The max. permissible total current is 1.5 A.

Ordering data

Ordering data	Article No.	Ordering data	Article No.
TM SIWAREX WP351 HF weighing module SIMATIC ET 200SP, TM SIWAREX WP351 HF, legal-for-trade weighing module for automatic dosing, filling and checking scales and totalizing weighing instruments	7MH4138-6BA00-0CU0	SIWAREX IS Ex interface For intrinsically safe connection of load cells. With ATEX approval (not UL/FM). Suitable for SIWAREX electronic weighing systems. Compatibility of load cells must be checked separately.	
SIWAREX WP351 Equipment Manual		• With short-circuit current < 199 mA DC	7MH4710-5BA
Available in a range of languages		• With short-circuit current < 137 mA DC	7MH4710-5CA
Free download on the Internet at: http://www.siemens.com/weighing/documentation		Cable (optional)	
SIWAREX WP351 "Getting Started" sample project		Cable Li2Y 1 x 2 x 0.75 ST + 2 x (2 x 0.34 ST) - CY	
Sample software shows beginners how to program the scales in TIA Portal V15.1		For connecting SIWAREX electronic weighing systems to junction box (JB), extension box (EB) and Ex interface or between two EBs. For permanent installation. Occasional bending is possible.	
Free download on the Internet at: http://www.siemens.com/weighing/documentation		External diameter: approx. 10.8 mm (0.43 inch)	
ET 200SP BaseUnit type U0		Permissible ambient temperature -40 ... +80 °C (-40 ... +176 °F)	
• For constructing a new potential group (white)	6ES7193-6BP00-0DU0	Sold by the meter.	
• For continuing an existing potential group (gray)	6ES7193-6BP00-0BU0	• Sheath color: orange	7MH4702-8AG
Shield connection for ET 200SP	6ES7193-6SC00-1AM0	• For hazardous atmospheres. Sheath color: blue.	7MH4702-8AF
Includes 5 shield connections		Commissioning	
SIWAREX JB junction box, aluminum housing	7MH5001-0AA20	Commissioning charge for one static scale with SIWAREX module	9LA1110-8SN50-0AA0
For connecting up to 4 load cells in parallel, and for connecting multiple junction boxes.		(Flat charge for travel and setup must be ordered separately)	
SIWAREX JB junction box, stainless steel housing	7MH5001-0AA00	Scope:	
For connecting up to 4 load cells in parallel.		• Recording of data	
SIWAREX JB junction box, stainless steel housing (ATEX)	7MH4710-1EA01	• Checking of mechanical installation of the scale	
For parallel connection of up to 4 load cells (for zone allocation, see manual or type-examination certificate).		• Checking of electrical wiring and function	
		• Static adjustment of the scale	
		Requirements:	
		• Mechanical design functional	
		• Modules electrically wired and tested	
		• Calibration weights available	
		• Free access to scale	
		Flat charge for travel and setup in Germany	9LA1110-8RA10-0AA0

I/O systems

SIMATIC ET 200 systems for the control cabinet
SIMATIC ET 200SP

I/O modules > Technology modules > SIPLUS ET 200SP ECC charging controller

Overview



SIPLUS Electrical Charging Controllers are the key components in infrastructure solutions for the conductive charging of electric vehicles.

They perform the following functions:

- Detection of the charging cable and its permissible current carrying capacity
- Transfer of the maximum charging current from the charging station to the electric vehicle
- Evaluation of the status signals from the electric vehicle:
 - Ready for charging
 - Charging
 - Charging with ventilation
- Cost-optimized, space-saving charging infrastructure solutions due to compact design based on SIMATIC ET 200SP

SIPLUS ET 200SP TM ECC 2xPWM ST AC module

- Control of charging outputs according to IEC 61851 by parameterizable SIPLUS ET 200SP TM ECC 2xPWM ST charging controller
- Control of load tap-off
- Control of connector lock
- Evaluation of connector lock or load contactor status

Note

SIPLUS extreme products are based on SIMATIC standard products. The contents listed here were taken from the respective standard products. SIPLUS extreme-specific information was added.

Technical specifications

Article number	6AG1242-6TM10-2BB1
Based on	6FE1242-6TM10-0BB1 SIPLUS ET 200SP TM ECC 2xPWM ST
Ambient conditions	
Ambient temperature during operation	
• horizontal installation, min.	-30 °C; = Tmin
• horizontal installation, max.	60 °C; = Tmax
• vertical installation, min.	-30 °C; = Tmin
• vertical installation, max.	50 °C; = Tmax
Ambient temperature during storage/transportation	
• Storage, min.	-40 °C
• Storage, max.	70 °C
• Transportation, min.	-40 °C
• Transportation, max.	70 °C
Altitude during operation relating to sea level	
• Installation altitude above sea level, max.	5 000 m
• Ambient air temperature-barometric pressure-altitude	Tmin ... Tmax at 1 140 hPa ... 795 hPa (-1 000 m ... +2 000 m) // Tmin ... (Tmax - 10 K) at 795 hPa ... 658 hPa (+2 000 m ... +3 500 m) // Tmin ... (Tmax -20 K) at 658 hPa ... 540 hPa (+3 500 m ... +5 000 m)
Relative humidity	
• With condensation, tested in accordance with IEC 60068-2-38, max.	100 %; RH incl. condensation / frost (no commissioning in bedewed state), horizontal installation

Article number	6AG1242-6TM10-2BB1
Based on	6FE1242-6TM10-0BB1 SIPLUS ET 200SP TM ECC 2xPWM ST
Vibrations	
• Vibration resistance during operation acc. to IEC 60068-2-6	10 ... 58 Hz / 0.075 mm, 58 ... 150 Hz / 1 g
Shock testing	
• Shock resistance acc. to IEC 60068-2-27	15 g / 11 ms
Resistance	
Coolants and lubricants	
- Resistant to commercially available coolants and lubricants	Yes; Incl. diesel and oil droplets in the air
Use in stationary industrial systems	
- to biologically active substances according to EN 60721-3-3	Yes; Class 3B2 mold, fungus and dry rot spores (with the exception of fauna); Class 3B3 on request
- to chemically active substances according to EN 60721-3-3	Yes; Class 3C4 (RH < 75 %) incl. salt spray acc. to EN 60068-2-52 (severity degree 3); *
- to mechanically active substances according to EN 60721-3-3	Yes; Class 3S4 incl. sand, dust, *
- Against mechanical environmental conditions acc. to EN 60721-3-3	Yes; Class 3M8 using the SIPLUS Mounting Kit ET 200SP (6AG1193-6AA00-0AA0)

Technical specifications		Ordering data	Article No.
Article number	6AG1242-6TM10-2BB1	SIPLUS ET200SP TM ECC 2xPWM ST charging controller	6AG1242-6TM10-2BB1
Based on	6FE1242-6TM10-0BB1 SIPLUS ET 200SP TM ECC 2xPWM ST		
Usage in industrial process technology		(Exposure to media)	
- Against chemically active substances acc. to EN 60654-4	Yes; Class 3 (excluding trichlorethylene)	Designed for controlling charging outputs according to IEC 61851 and parameterizable, with 2 charging outputs, ambient temperature -30 °C ... 60° C	
- Environmental conditions for process, measuring and control systems acc. to ANSI/ISA-71.04	Yes; Level GX group A/B (excluding trichlorethylene; harmful gas concentrations up to the limits of EN 60721-3-3 class 3C4 permissible); level LC3 (salt spray) and level LB3 (oil)	2x control pilot, 2x plug present, 2x DQ switching contact for load contactor as open collector, 2x DI for load contactor feedback or connector lock	
Remark			
- Note regarding classification of environmental conditions acc. to EN 60721, EN 60654-4 and ANSI/ISA-71.04	* The supplied plug covers must remain in place over the unused interfaces during operation!		
Conformal coating			
• Coatings for printed circuit board assemblies acc. to EN 61086	Yes; Class 2 for high availability		
• Protection against fouling acc. to EN 60664-3	Yes; Type 1 protection		
• Military testing according to MIL-I-46058C, Amendment 7	Yes; Discoloration of coating possible during service life		
• Qualification and Performance of Electrical Insulating Compound for Printed Board Assemblies according to IPC-CC-830A	Yes; Conformal coating, Class A		

I/O systems

SIMATIC ET 200 systems for the control cabinet
SIMATIC ET 200SP

I/O modules > Technology modules > SIPLUS SIWAREX WP321

Overview



SIPLUS WP321 is a versatile and flexible weighing module for the seamless integration of a static scale into the SIMATIC automation environment.

The electronic weighing system is integrated in the SIPLUS ET 200SP series and uses all the features of a modern automation system, such as integrated communication, operator control and monitoring, diagnostic system and configuration tools in the TIA Portal, SIMATIC STEP 7, WinCC flexible and PCS7.

Note

SIPLUS extreme products are based on SIMATIC standard products. The contents listed here were taken from the corresponding standard products. SIPLUS extreme-specific information has been added.

SIPLUS WP321	
Article No.	6AG1138-6AA00-2BA8
Article No. based on	7MH4138-6AA00-0BA0
Ambient temperature range	-40 ... +60 °C
Conformal coating	Coating of the printed circuit boards and the electronic components
Technical specifications	The technical specifications of the standard product apply, except for the ambient conditions.

Technical specifications

SIPLUS WP321	
Integration in automation systems	
SIPLUS S7-300, S7-400, S7-1200 and S7-1500	Via SIPLUS ET 200SP interface module (PROFIBUS or PROFINET)
Other manufacturers (with restrictions)	Via SIPLUS ET 200SP interface module (PROFIBUS or PROFINET)
Communication interfaces	
	<ul style="list-style-type: none"> • SIPLUS ET 200SP backplane bus • RS 485 (SIWATOOL, Siebert remote display)
Commissioning options	
	<ul style="list-style-type: none"> • Using SIWATOOL V7 • Using a function block in SIPLUS CPU / touch panel
Measuring accuracy	
According to DIN 1319-1 of full-scale value at 20 °C ± 10 K (68 °F ± 10 K)	0.05 %
Internal resolution	± 2 million parts
Measuring frequency	100 / 120 / 600 Hz
Digital filter	
	Variable low-pass and average filter
Typical applications	
	<ul style="list-style-type: none"> • Non-automatic weighing instruments • Force measurements • Level monitoring • Belt tension monitoring
Weighing functions	
Weight values	<ul style="list-style-type: none"> • Gross • Net • Tare
Limit values	<ul style="list-style-type: none"> • 2 x min./max. • Empty
Zeroing	Via command from controller or HMI
Taring	Via command from controller or HMI
External tare specification	Via command from controller or HMI
Calibration commands	Via command from controller or HMI
Load cells	
	Full-bridge strain gauges in 4-wire or 6-wire system
Load cell powering	
Supply voltage (value applies at sensor, cable-related voltage drops of up to 5 V are compensated)	4.85 V DC ± 2%
Permissible load resistance	<ul style="list-style-type: none"> • R_{Lmin} > 40 Ω • R_{Lmax} < 4 100 Ω
With SIWAREX IS Ex interface	<ul style="list-style-type: none"> • R_{Lmin} > 50 Ω • R_{Lmax} < 4 100 Ω
Load cell characteristic	1 ... 4 mV/V
Permissible measuring signal range (at greatest set characteristic value)	-21.3 ... +21.3 mV
Max. load cell distance	1 000 m (459.32 ft)
Auxiliary power	
Nominal voltage	24 V DC
Max. power consumption	Typ. 0.1 A @ 24 V DC (0.2 A max.)
Max. SIMATIC bus power consumption	30 mA

I/O systems

SIMATIC ET 200 systems for the control cabinet
SIMATIC ET 200SP

I/O modules > Technology modules > SIPLUS SIWAREX WP321

Ordering data**Article No.****Article No.****Ex interface, type SIWAREX IS**

For intrinsically-safe connection of load cells. With ATEX approval (not UL/FM). Suitable for SIWAREX electronic weighing systems. Compatibility of the load cells must be checked separately.

- With short-circuit current < 199 mA DC
- With short-circuit current < 137 mA DC

7MH4710-5BA**7MH4710-5CA****Cables (optional)****Cable Li2Y 1 x 2 x 0.75 ST + 2 x (2 x 0.34 ST) CY, orange sheath**

For connecting SIWAREX electronic weighing systems to junction boxes (JB), extension boxes (EB) and Ex interface or between two EBs. For permanent installation. Occasional bending is permitted.

Outer diameter:
approx. 10.8 mm (0.43 inch)
Permissible ambient temperature
-40 ... +80 °C (-40 ... +176 °F)

Sold by the meter

Sheath color: orange

For hazardous areas.
Sheath color: blue

7MH4702-8AG**7MH4702-8AF***Configuration software***SIWATOOL V4 & V7**

Service and commissioning software for SIWAREX weighing modules

7MH4900-1AK01**SIWAREX PCS7 AddOn Library for PCS7 V8.x and V9.0**

- Supports PROFINET

7MH4900-1AK61

APL faceplates and function blocks for:

- SIWAREX U
- SIWAREX FTA
- SIWAREX FTC_B (belt scales)
- SIWAREX WP321

Classic faceplate and function block for:

- SIWAREX FTC_L (loss in weight)

*Documentation***SIWAREX WP321 manual**

Available in a range of languages
Free download from the Internet at:
<http://www.siemens.com/weighing/documentation>

SIWAREX WP321 "Ready for use"

TIA Portal and SIMATIC Manager sample configuration

Free download on the Internet at:
<http://www.siemens.com/weighing/documentation>

SIMATIC Manual Collection

Electronic manuals on DVD, multilingual:
LOGO!, SIMADYN,
SIMATIC bus components,
SIMATIC C7,
SIMATIC distributed I/O,
SIMATIC HMI, SIMATIC sensors,
SIMATIC NET, SIMATIC PC-Based Automation, SIMATIC PCS 7,
SIMATIC PG/PC, SIMATIC S7,
SIMATIC software, SIMATIC TDC

6ES7998-8XC01-8YE0**SIMATIC Manual Collection update service for 1 year**

Current "Manual Collection" DVD and the three subsequent updates

6ES7998-8XC01-8YE2

Overview

- DALI-2 multimaster module for 1 bus strand
- Allows the control, diagnostics and parameter assignment of up to 64 luminaires and 63 sensors via a 2-wire bus line
- Typical areas of application: Lighting in tunnels, (factory) halls or ships
- Realization of the control via prefabricated blocks of a function module library in the TIA Portal
- DALI (Digital Addressable Lighting Interface) certification according to DALI V2 for IEC 62386-101/-103 parts
- Different DALI device types, such as LED modules, fluorescent lamps, discharge lamps, low-voltage halogen lamps and others, can be used

Technical specifications

Article number	6ES7137-6CA00-0BU0 ET 200SP, CM 1x DALI
General information	
Product type designation	CM 1xDALI
Product function	
• I&M data	Yes; I&M0 to I&M3
Engineering with	
• STEP 7 TIA Portal configurable/ integrated as of version	STEP 7 V15.1 or higher
• PROFIBUS as of GSD version/ GSD revision	GSD Revision 5
• PROFINET as of GSD version/ GSD revision	GSDML V2.34
Supply voltage	
Rated value (DC)	24 V
Reverse polarity protection	Yes
DALI	
• Integrated power supply	Yes
- Supply current, min.	160 mA
- Supply current, max.	250 mA
- Can be switched off	Yes
• Cable length, max.	300 m
DALI	
• Standard according to DALI	DALI V2 Multi-Master
Supported operating devices	
- Fluorescent lamps (device type 0)	Yes
- Emergency lighting with single battery (device type 1)	Yes
- Discharge lamps (device type 2)	Yes
- Low-voltage halogen lamps (device type 3)	Yes
- Incandescent lamps (device type 4)	Yes
- Direct voltage (device type 5)	Yes
- LED modules (device type 6)	Yes
- Switching function (device type 7)	Yes
- Color control (device type 8)	Yes
- Further operating devices	Yes; general device type
Supported input devices	
- Pushbuttons	Yes
- Absolute input devices	Yes
- Presence detector	Yes
- Light sensor	Yes
- Further input devices	Yes; general device type

Article number	6ES7137-6CA00-0BU0 ET 200SP, CM 1x DALI
Interrupts/diagnostics/ status information	
Alarms	
• Diagnostic alarm	Yes
Diagnostic messages	
• Short-circuit	Yes; On DALI bus
Diagnostics indication LED	
• ERROR LED	Yes
• Monitoring of the supply voltage (PWR-LED)	Yes; green PWR LED
• Receive RxD	Yes; green LED
• Transmit TxD	Yes; green LED
Potential separation	
between backplane bus and interface	Yes
Ambient conditions	
Ambient temperature during operation	
• horizontal installation, min.	-30 °C
• horizontal installation, max.	60 °C
• vertical installation, min.	-30 °C
• vertical installation, max.	50 °C
Altitude during operation relating to sea level	
• Installation altitude above sea level, max.	3 000 m; Restrictions for installation altitudes > 2 000 m, see manual
Decentralized operation	
to SIMATIC S7-1200	Yes; FW V4.0 or higher
to SIMATIC S7-1500	Yes
Dimensions	
Width	20 mm
Height	73 mm
Depth	58 mm
Weights	
Weight, approx.	50 g

I/O systems

SIMATIC ET 200 systems for the control cabinet

SIMATIC ET 200SP

I/O modules > Communication > CM 1xDALI

Ordering data	Article No.	Accessories	Article No.
<p>DALI-V2 multimaster module CM 1xDALI</p> <p>For control of lighting solutions with DALI V2, BU type U0, color code CC20</p>	<p>6ES7137-6CA00-0BU0</p>	<p>Suitable type U0 BaseUnits</p> <p>BU20-P16+A0+2D</p> <p>BU type U0; BaseUnit (light) with 16 push-in terminals to the module; for starting a new load group (max. 10 A)</p> <ul style="list-style-type: none"> • 1 unit • 10 units <p>BU20-P16+A0+2B</p> <p>BU type U0; BaseUnit (dark) with 16 push-in terminals to the module; for continuing the load group</p> <ul style="list-style-type: none"> • 1 unit • 10 units <p>Equipment labeling plates</p> <p>10 sheets of 16 plates</p> <p>Labeling strips</p> <p>500 labeling strips on roll, light gray, for inscription with thermal transfer roll printer</p>	<p>6ES7193-6BP00-0DU0 6ES7193-6BP00-2DU0</p> <p>6ES7193-6BP00-0BU0 6ES7193-6BP00-2BU0</p> <p>6ES7193-6LF30-0AW0</p> <p>6ES7193-6LR10-0AA0</p>

Overview

- For data exchange between an ET 200SP system and CAN Bus 2.0A/B or CANopen manager or slave (according to CiA 301 & 302)
- CANopen features:
 - Node / lifeguarding
 - Heartbeat
 - SYNC (producer / consumer)
- Integrated in TIA via HSP, TIA Portal V15.1 or higher
- CAN connection with push-in terminals
- Integrated CAN bus terminating resistor
- Up to 60 CAN nodes
- 128 receiver and 128 transmitter PDOs
- Galvanic isolation between the two networks
- Diagnostic interrupts

Ordering data**Article No.****ET 200SP CM CAN communications modules****6ES7137-6EA00-0BA0**

To connect ET 200SP with CAN bus or CANopen networks
CAN bus 2.0A/B,
CANopen manager
according to CiA301/302,
CANopen slave
according to CiA301/302

Accessories**Usable type A0 BaseUnits****BU15-P16+A0+2D**

BU type A0; BaseUnit (light) with 16 push-in terminals to the module; for starting a new load group (max. 10 A)

- 1 unit
- 10 units

6ES7193-6BP00-0DA0
6ES7193-6BP00-2DA0

BU15-P16+A0+2B

BU type A0; BaseUnit (dark) with 16 push-in terminals to the module; for continuing the load group

- 1 unit
- 10 units

6ES7193-6BP00-0BA0
6ES7193-6BP00-2BA0

I/O systems

SIMATIC ET 200 systems for the control cabinet
SIMATIC ET 200SP

Fail-safe I/O modules > Analog F-input modules

Overview



Analog fail-safe input modules:

- F-AI 4xI 0(4)..20 mA 2/4-wire High Feature for BU types A0 and A1, color code CC00
- F-AI 4xU 0..10 V HF, BU type A0, A1, color code CC00

Important features:

- 4-channel analog fail-safe digital inputs for ET 200SP
- 4 analog inputs with galvanic isolation between channels and backplane bus
- Measuring ranges: (0)4...20 mA and 0..10 V
- Possibility of connecting current and voltage sensors for measuring temperature, pressure, flow, level, distance measurement, etc.

- Short-circuit-proof power supply for analog sensors
- Resolution: 16 bits including sign
- Certified up to SIL 3 (IEC 61508), PL e (ISO 13849)
- Can be plugged onto type A0 and A1 BaseUnits (BU)
- LED display for error, operation, supply voltage and status
- Interference frequency suppression, smoothing
- Diagnostics: wire break, short-circuit, high/low limit violation
- Firmware update
- Identification data I&M
- Value status
- Clear labeling on front of module
 - Plain text identification of the module type and function class
 - 2D matrix code (order and serial number)
 - Connection diagram
 - Color coding of the module type DI: white
 - Hardware and firmware version
 - Color code CC for module-specific color coding of the potentials at the terminals of the BU
 - Complete Article No.
- Optional labeling accessories
 - Labeling strips
 - Equipment labeling plate
- Optional module-specific color identification of the terminals according to the color code CC
- Optional system-integrated shield connection
- The modules support PROFIsafe in both PROFIBUS and PROFINET configurations. They can be used with all fail-safe SIMATIC S7 CPUs.

Technical specifications

Article number	6ES7136-6AA00-0CA1	6ES7136-6AB00-0CA1
	ET 200SP, F-AI 4XI (0)4..20mA HF	ET 200SP, F-AI 4xU 0..10V HF
General information		
Product type designation	F-AI 4xI 0(4)..20mA 2-/4-wire HF	F-AI 4xU 0..10V HF
Product function		
• I&M data	Yes; I&M0 to I&M3	Yes; I&M0 to I&M3
Engineering with		
• STEP 7 TIA Portal configurable/integrated as of version	V15 with HSP 203	V16 with HSP 308
Operating mode		
• cyclic measurement		Yes
• Oversampling		No
• MSI		No
Supply voltage		
Rated value (DC)	24 V	24 V
Reverse polarity protection	Yes	Yes
Analog inputs		
Number of analog inputs	4	4
• For current measurement	4	
• For voltage measurement		4
permissible input voltage for voltage input (destruction limit), max.		35 V
permissible input current for current input (destruction limit), max.	35 mA	

Technical specifications

Article number	6ES7136-6AA00-0CA1 ET 200SP, F-AI 4XI (0)4..20mA HF	6ES7136-6AB00-0CA1 ET 200SP, F-AI 4xU 0..10V HF
Input ranges (rated values), voltages • 0 to +10 V		Yes
Input ranges (rated values), currents • 0 to 20 mA • 4 mA to 20 mA	Yes Yes	
Cable length • shielded, max.	1 000 m	200 m
Analog value generation for the inputs		
Measurement principle	Sigma Delta	Sigma Delta
Integration and conversion time/resolution per channel • Resolution with overrange (bit including sign), max. • Integration time, parameterizable • Integration time (ms) • Interference voltage suppression for interference frequency f1 in Hz	16 bit Yes 20 / 16,667 50 / 60 Hz	16 bit Yes 20 / 16,667 50 / 60 Hz
Smoothing of measured values • Number of smoothing levels • parameterizable • Average value filter	7 Yes	7 Yes Yes
Encoder		
Connection of signal encoders • for voltage measurement • for current measurement as 2-wire transducer - Burden of 2-wire transmitter, max. • for current measurement as 4-wire transducer	Yes 650 Ω Yes	Yes
Errors/accuracies		
Basic error limit (operational limit at 25 °C) • Voltage, relative to input range, (+/-) • Current, relative to input range, (+/-)	0.1 %	0.1 %
Interference voltage suppression for $f = n \times (f1 \pm 1 \%)$, f1 = interference frequency • Series mode interference (peak value of interference < rated value of input range), min. • Common mode voltage, max. • Common mode interference, min.	40 dB 70 dB	40 dB 10 V 70 dB
Interrupts/diagnostics/status information		
Diagnostics function	Yes	Yes
Alarms • Diagnostic alarm • Limit value alarm	Yes No	Yes No
Diagnostic messages • Monitoring the supply voltage • Wire-break • Short-circuit	Yes Yes; Measuring range 4 to 20 mA only Yes	Yes Yes

I/O systems

SIMATIC ET 200 systems for the control cabinet
SIMATIC ET 200SP

Fail-safe I/O modules > Analog F-input modules

Technical specifications

Article number	6ES7136-6AA00-0CA1 ET 200SP, F-AI 4XI (0)4..20mA HF	6ES7136-6AB00-0CA1 ET 200SP, F-AI 4xU 0..10V HF
Diagnostics indication LED		
• RUN LED	Yes; green LED	Yes; green LED
• ERROR LED	Yes; red LED	Yes; red LED
• Monitoring of the supply voltage (PWR-LED)	Yes; green PWR LED	Yes; green PWR LED
• Channel status display	Yes; green LED	Yes; green LED
• for channel diagnostics	Yes; red LED	Yes; red LED
• for module diagnostics	Yes; green/red LED	Yes; green/red LED
Potential separation		
Potential separation channels		
• between the channels and backplane bus	Yes	Yes
Standards, approvals, certificates		
Highest safety class achievable in safety mode		
• Performance level according to ISO 13849-1	PLe	PLe
• SIL acc. to IEC 61508	SIL 3	SIL 3
Ambient conditions		
Ambient temperature during operation		
• horizontal installation, min.	0 °C	0 °C
• horizontal installation, max.	60 °C	60 °C
• vertical installation, min.	0 °C	0 °C
• vertical installation, max.	50 °C	50 °C
Dimensions		
Width	15 mm	15 mm
Height	73 mm	73 mm
Depth	58 mm	58 mm
Weights		
Weight, approx.	48 g	48 g

Ordering data

Analog fail-safe input module

F-AI 4xI 0(4) ... 20 mA 2/4-wire High Feature, BU type A0, A1, color code CC00

6ES7136-6AA00-0CA1

F-AI 4xU 0..10 V High Feature, BU type A0, A1, color code CC00

6ES7136-6AB00-0CA1

Suitable BaseUnits

BU15-P16+A10+2D

BU type A0; BaseUnit (light) with 16 process terminals (1 ... 16) to the module and an additional 10 internally jumpered AUX terminals (1 A to 10 A); for starting a new load group (max. 10 A)

- 1 unit
- 10 units

6ES7193-6BP20-0DA0
6ES7193-6BP20-2DA0

BU15-P16+A0+2D

BU type A0; BaseUnit (light) with 16 process terminals to the module; for starting a new load group (max. 10 A)

- 1 unit
- 10 units

6ES7193-6BP00-0DA0
6ES7193-6BP00-2DA0

2BU15-P16+A0+2DB

Double BaseUnit for holding 2 I/O modules; BU type A0; BaseUnit (light/dark) with 16 process terminals to the module; for starting a new load group (max. 10 A)

- 1 unit

6ES7193-6BP60-0DA0

BU15-P16+A10+2B

BU type A0; BaseUnit (dark) with 16 process terminals (1 ... 16) to the module and an additional 10 internally jumpered AUX terminals (1 A to 10 A); for continuing the load group

- 1 unit
- 10 units

6ES7193-6BP20-0BA0
6ES7193-6BP20-2BA0

BU15-P16+A0+2B

BU type A0; BaseUnit (dark) with 16 process terminals to the module; for continuing the load group

- 1 unit
- 10 units

6ES7193-6BP00-0BA0
6ES7193-6BP00-2BA0

Ordering data	Article No.	Ordering data	Article No.
2BU15-P16+A0+2B Double BaseUnit for holding 2 I/O modules; BU type A0; BaseUnit (dark/dark) with 16 push-in terminals to the module; for continuing the load group • 1 unit	6ES7193-6BP60-0BA0	Accessories STEP 7 Safety Advanced V16 Task: Engineering tool for configuring and programming fail-safe user programs for SIMATIC S7-1200 FC, S7-1500F, S7-1500F Software Controller, S7-300F, S7-400F, WinAC RTX F, ET 200SP F Controller and the fail-safe ET 200SP, ET 200MP, ET 200S, ET 200M, ET 200iSP, ET 200pro and ET 200eco I/O Requirement: STEP 7 Professional V16 Note: As from TIA Portal V16, the SIMATIC STEP 7 Safety software is an integral part of the SIMATIC STEP 7 product setup. The functionality of SIMATIC STEP 7 Safety is activated by means of the license key supplied in each case. Floating license for 1 user; license key on USB flash drive Floating license for 1 user, license key for download ¹⁾ ; email address required for delivery	
BU15-P16+A0+12D/T BU type A1; BaseUnit (light) with 16 process terminals (1 ... 16) to the module and 2x5 internally jumpered additional terminals (1 B to 5 B and 1 C to 5 C); for starting a new load group (max. 10 A)	6ES7193-6BP40-0DA1	Equipment labeling plates 10 sheets of 16 plates	6ES7833-1FA16-0YA5 6ES7833-1FA16-0YH5
BU15-P16+A0+2D/T BU type A1; BaseUnit (light) with 16 process terminals to the module; for starting a new load group (max. 10 A)	6ES7193-6BP00-0DA1	Labeling strips 500 labeling strips on roll, light gray, for inscription with thermal transfer roll printer 500 labeling strips on roll, yellow, for inscription with thermal transfer roll printer 1 000 labeling strips DIN A4, light gray, card, for inscription with laser printer 1 000 labeling strips DIN A4, yellow, card, for inscription with laser printer	6ES7193-6LF30-0AW0
BU15-P16+A0+12B/T BU type A1; BaseUnit (dark) with 16 process terminals (1 ... 16) to the module and 2x5 internally jumpered additional terminals (1 B to 5 B and 1 C to 5 C); for continuing the load group	6ES7193-6BP40-0BA1	BU cover For covering empty slots (gaps); 5 units • 15 mm wide	6ES7133-6CV15-1AM0
BU15-P16+A0+2B/T BU type A1; BaseUnit (dark) with 16 process terminals to the module; for continuing the load group	6ES7193-6BP00-0BA1	Shield connection 5 shield supports and 5 shield terminals	6ES7193-6SC00-1AM0
		Color-coded labels • Color code CC00, for 16 push-in terminals, BU type A0, A1, gray (terminals 1 to 8), red (terminals 9 to 16); A1; 10 units	6ES7193-6CP00-2MA0

¹⁾ For up-to-date information and download availability, see: <http://www.siemens.com/tia-online-software-delivery>

I/O systems

SIMATIC ET 200 systems for the control cabinet
SIMATIC ET 200SP

Fail-safe I/O modules > SIPLUS analog F-input modules

Overview



Analog fail-safe input module:
SIPLUS F-AI 4xI 0(4) ... 20 mA 2/4-wire High Feature
for BU type A0 and A1, color code CC00

Important features:

- 4 analog inputs with galvanic isolation between channels and backplane bus (up to SIL 3/Cat. 4/PL d)
- Short-circuit-proof power supply of 2 or 4-wire transducers
- Measuring ranges: 0 ... 20 mA and 4 ... 20 mA
- Resolution: 16 bits including sign

- Certified up to SIL 3 (IEC 61508), PL e (ISO 13849)
- Can be plugged onto type A0 and A1 BaseUnits (BU)
- LED display for error, operation, supply voltage and status
- Clear labeling on front of module
 - Plain text identification of the module type and function class
 - 2D matrix code (order and serial number)
 - Connection diagram
 - Color coding of the module type DI: white
 - Hardware and firmware version
 - Color code CC for module-specific color coding of the potentials at the terminals of the BU
 - Complete article No.
- Optional labeling accessories
 - Labeling strips
 - Equipment labeling plate
- Optional module-specific color identification of the terminals according to the color code CC
- Optional system-integrated shield connection
- The modules support PROFIsafe in both PROFIBUS and PROFINET configurations. They can be used with all fail-safe SIMATIC S7 CPUs.

Note:

SIPLUS extreme products are based on SIMATIC standard products. The contents listed here were adopted from the respective standard products. SIPLUS extreme-specific information was added.

Technical specifications

Article number	6AG1136-6AA00-2CA1
Based on	6ES7136-6AA00-0CA1 SIPLUS ET 200SP F-AI 4xI 2-/4-wire HF
Ambient conditions	
Ambient temperature during operation	
• horizontal installation, min.	-25 °C; = Tmin (incl. condensation/frost)
• horizontal installation, max.	60 °C; = Tmax; +70 °C with configured slots to the left and right of the module
• vertical installation, min.	-25 °C; = Tmin
• vertical installation, max.	50 °C
Altitude during operation relating to sea level	
• Installation altitude above sea level, max.	2 000 m
• Ambient air temperature-barometric pressure-altitude	Tmin ... Tmax at 1 140 hPa ... 795 hPa (-1 000 m ... +2 000 m)
Relative humidity	
• With condensation, tested in accordance with IEC 60068-2-38, max.	100 %; RH incl. condensation / frost (no commissioning in bedewed state), horizontal installation
Resistance	
Coolants and lubricants	
- Resistant to commercially available coolants and lubricants	Yes; Incl. diesel and oil droplets in the air

Article number	6AG1136-6AA00-2CA1
Based on	6ES7136-6AA00-0CA1 SIPLUS ET 200SP F-AI 4xI 2-/4-wire HF
Use in stationary industrial systems	
- to biologically active substances according to EN 60721-3-3	Yes; Class 3B2 mold, fungus and dry rot spores (with the exception of fauna); Class 3B3 on request
- to chemically active substances according to EN 60721-3-3	Yes; Class 3C4 (RH < 75 %) incl. salt spray acc. to EN 60068-2-52 (severity degree 3); *
- to mechanically active substances according to EN 60721-3-3	Yes; Class 3S4 incl. sand, dust, *
- Against mechanical environmental conditions acc. to EN 60721-3-3	Yes; Class 3M8 using the SIPLUS Mounting Kit ET 200SP (6AG1193-6AA00-0AA0)
Use on ships/at sea	
- to biologically active substances according to EN 60721-3-6	Yes; Class 6B2 mold, fungal and dry rot spores (excluding fauna)
- to chemically active substances according to EN 60721-3-6	Yes; Class 6C3 (RH < 75 %) incl. salt spray acc. to EN 60068-2-52 (severity degree 3); *
- to mechanically active substances according to EN 60721-3-6	Yes; Class 6S3 incl. sand, dust; *
- Against mechanical environmental conditions acc. to EN 60721-3-6	Yes; Class 6M4 using the SIPLUS Mounting Kit ET 200SP (6AG1193-6AA00-0AA0)

Technical specifications

Article number	6AG1136-6AA00-2CA1
Based on	6ES7136-6AA00-0CA1 SIPLUS ET 200SP F-AI 4xI 2-/4-wire HF
Usage in industrial process technology	<p>Yes; Class 3 (excluding trichlorethylene)</p> <p>Yes; Level GX group A/B (excluding trichlorethylene; harmful gas concentrations up to the limits of EN 60721-3-3 class 3C4 permissible); level LC3 (salt spray) and level LB3 (oil)</p>
Remark	* The supplied plug covers must remain in place over the unused interfaces during operation!
- Against chemically active substances acc. to EN 60654-4	
- Environmental conditions for process, measuring and control systems acc. to ANSI/ISA-71.04	
- Note regarding classification of environmental conditions acc. to EN 60721, EN 60654-4 and ANSI/ISA-71.04	

Article number	6AG1136-6AA00-2CA1
Based on	6ES7136-6AA00-0CA1 SIPLUS ET 200SP F-AI 4xI 2-/4-wire HF
Conformal coating	<ul style="list-style-type: none"> Coatings for printed circuit board assemblies acc. to EN 61086 Protection against fouling acc. to EN 60664-3 Military testing according to MIL-I-46058C, Amendment 7 Qualification and Performance of Electrical Insulating Compound for Printed Board Assemblies according to IPC-CC-830A
Yes; Class 2 for high availability	
Yes; Type 1 protection	
Yes; Discoloration of coating possible during service life	
Yes; Conformal coating, Class A	

Ordering data

Ordering data	Article No.
SIPLUS analog F-input module (Extended temperature range and exposure to media) F-AI 4xI 0(4) ... 20 mA 2/4-wire High Feature, BU type A0, A1, color code CC00	6AG1136-6AA00-2CA1
Suitable BaseUnits	
BU15-P16+A10+2D (Extended temperature range and exposure to media) BU type A0; BaseUnit (light) with 6 process terminals (1...16) to the module and an additional 10 internally jumpered AUX terminals (1 A to 10 A); for starting a new load group (max. 10 A)	6AG1193-6BP20-7DA0
BU15-P16+A0+2D (Extended temperature range and exposure to media) BU type A0; BaseUnit (light) with 16 process terminals to the module; for starting a new load group (max. 10 A)	6AG1193-6BP00-7DA0
BU15-P16+A10+2B (Extended temperature range and exposure to media) BU type A0; BaseUnit (dark) with 16 process terminals (1...16) to the module and an additional 10 internally jumpered AUX terminals (1 A to 10 A); for continuing the load group	6AG1193-6BP20-7BA0
BU15-P16+A0+2B (Extended temperature range and exposure to media) BU type A0; BaseUnit (dark) with 16 process terminals to the module; for continuing the load group	6AG1193-6BP00-7BA0

Ordering data	Article No.
BU15-P16+A0+12D/T (Extended temperature range and exposure to media) BU type A1; BaseUnit (light) with 16 process terminals (1...16) to the module and 2x5 internally jumpered additional terminals (1 B to 5 B and 1 C to 5 C); for starting a new load group (max. 10 A)	6AG1193-6BP40-7DA1
BU15-P16+A0+2D/T (Extended temperature range and exposure to media) BU type A1; BaseUnit (light) with 16 process terminals to the module; for starting a new load group (max. 10 A)	6AG1193-6BP00-7DA1
BU15-P16+A0+12B/T (Extended temperature range and exposure to media) BU type A1; BaseUnit (dark) with 16 process terminals (1...16) to the module and 2x5 internally jumpered additional terminals (1 B to 5 B and 1 C to 5 C); for continuing the load group	6AG1193-6BP40-7BA1
BU15-P16+A0+2B/T (Extended temperature range and exposure to media) BU type A1; BaseUnit (dark) with 16 process terminals to the module; for continuing the load group	6AG1193-6BP00-7BA1
Accessories	See SIMATIC ET 200SP, Analog F-input modules, page 10/37

I/O systems

SIMATIC ET 200 systems for the control cabinet
SIMATIC ET 200SP

I/O modules > SIMATIC ET 200SP drive controllers > SIMATIC MICRO-DRIVE F-TM ServoDrive

Overview



Engineering in the TIA Portal stands for consistency in a single tool. This facilitates drive dimensioning, commissioning and servicing.

The new drive system consists of

- The F-TM ServoDrive as a new member of the SIMATIC MICRO-DRIVE family
- The BaseUnit (U0)
- Flexible usable motors with gearbox and
- Connecting cables.

Characteristics

- PROFIdrive profile via PROFINET
- Hardware STO
- Digital input
- Integrated braking chopper
- Encoder connection for - IQ encoders

In combination with EC motors, the new ET 200SP technology module F-TM ServoDrive allows positioning and control of speeds up to 280 W in very confined spaces.

10

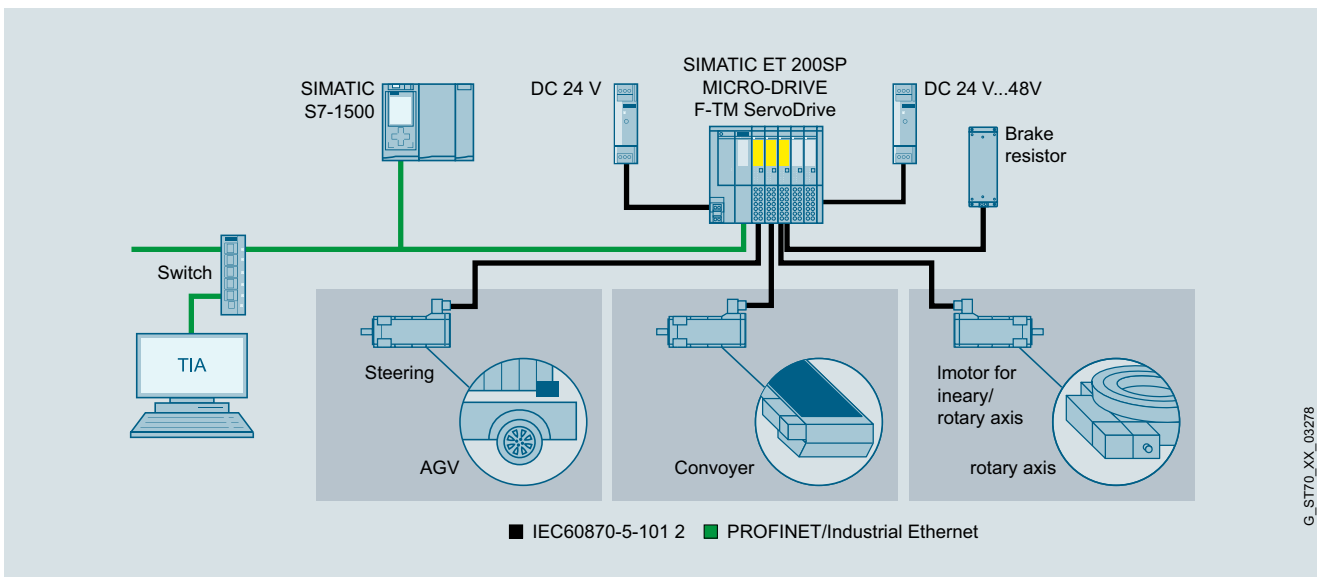

F-TM ServoDrive drive controller

Variant	Power	Device width	Start of delivery
Standard	280 W	20 mm	Available

More information:

<https://www.siemens.com/micro-drive>

G_STT0_XX_03278

Technical specifications

Article number	6BK1136-6AB00-0BU0 F-TM ServoDrive 1x24...48V 5A ST
General information	
Product type designation	F-TM ServoDrive 1x24 ... 48 V 5 A ST
Product description	Control of EC motors
Product function	
• I&M data	Yes
• Isochronous mode	No
• Four-quadrant operation	Yes
• Safety Functions	Yes; Drive controller with hardwired STO
Protection function	
• Undervoltage protection	Yes
• Overvoltage protection	Yes
• Overload protection	Yes
• Ground-fault protection	No
• Short-circuit protection	Yes
Installation type/mounting	
Type of ventilation	Convection cooling
Supply voltage	
Design of the power supply permissible range, lower limit (DC)	24 ... 48 V DC, SELV / PELV 16.8 V
permissible range, upper limit (DC)	57.6 V
Output voltage	
Rated value, min.	24 V
Rated value, max.	48 V
Output current	
Current output (rated value)	5 A
Output current, max.	10 A
Output frequency	420 Hz
Encoder supply	
Number of outputs	1
5 V encoder supply	
• 5 V	Yes
• Short-circuit protection	Yes
• Output current, max.	120 mA
Digital inputs	
Number of digital inputs	1; + 1 input for message signal
Number of safety inputs	1; For STO, antivalent (2-pin) - 24 V DC
Encoder	
Connectable encoders	
• Incremental encoder (symmetrical)	No
Interrupts/diagnostics/status information	
Alarms	
• Diagnostic alarm	Yes
• Hardware interrupt	No
Diagnostic messages	
• Monitoring the supply voltage	Yes
• Wire-break	Yes
• Short-circuit	No
• Group error	Yes
Diagnostics indication LED	
• RUN LED	Yes
• ERROR LED	Yes
Integrated Functions	
Position detection	
• Incremental acquisition	Yes
Potential separation	
Potential separation channels	
• between the channels and backplane bus	Yes

Article number	6BK1136-6AB00-0BU0 F-TM ServoDrive 1x24...48V 5A ST
Degree and class of protection	
IP degree of protection	IP20
Standards, approvals, certificates	
CE mark	Yes
cULus	No
RCM (formerly C-TICK)	Yes
Standard for EMC according to EN 61800-3	Yes, according to second environment Category C2 acc. EN 61800-3
Standard for drive acc. to EN 61800-5-1	Yes
Standard for drive acc. to EN 61800-5-2	Yes
Highest safety class achievable in safety mode	
• Performance level according to ISO 13849-1	Category 3, performance level d, according to EN ISO 13849-1:2015
• SIL according to DIN EN 61800-5-2	SIL 2 according to EN 61800-5-2:2017
Ambient conditions	
Pollution degree during storage and transport	2
Ambient temperature during operation	
• horizontal installation, min.	-30 °C; No condensation, splash water, icing, salt spray or oil mist permitted.
• horizontal installation, max.	60 °C; No condensation, splash water, icing, salt spray or oil mist permitted. Note the derating data!
• vertical installation, min.	-30 °C; No condensation, splash water, icing, salt spray or oil mist permitted.
• vertical installation, max.	50 °C; No condensation, splash water, icing, salt spray or oil mist permitted. Note the derating data!
Ambient temperature during storage/transportation	
• Storage, min.	-40 °C
• Storage, max.	70 °C
Altitude during operation relating to sea level	
• Installation altitude above sea level, max.	3 000 m
Cables	
Cable length for motor, shielded, max.	10 m
Dimensions	
Width	20 mm
Height	73 mm
Depth	58 mm
Weights	
Weight, approx.	55 g
Other	
Braking chopper	Yes

Ordering data

Article No.

F-TM ServoDrive drive controller for SIMATIC MICRO-DRIVE

6BK1136-6AB00-0BU0

Variant

Standard V1;
24 ... 48 V, 5 A
with hardware STO and integrated braking chopper

I/O systems

SIMATIC ET 200 systems for the control cabinet
SIMATIC ET 200SP

I/O modules > ET 200SP motor starters

Overview

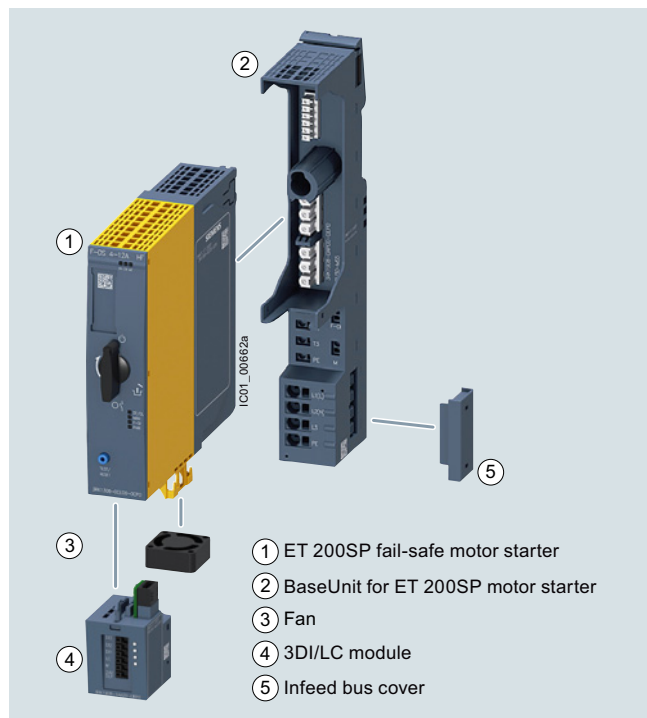

Motor starter, BaseUnit, fan and 3DI/LC control module

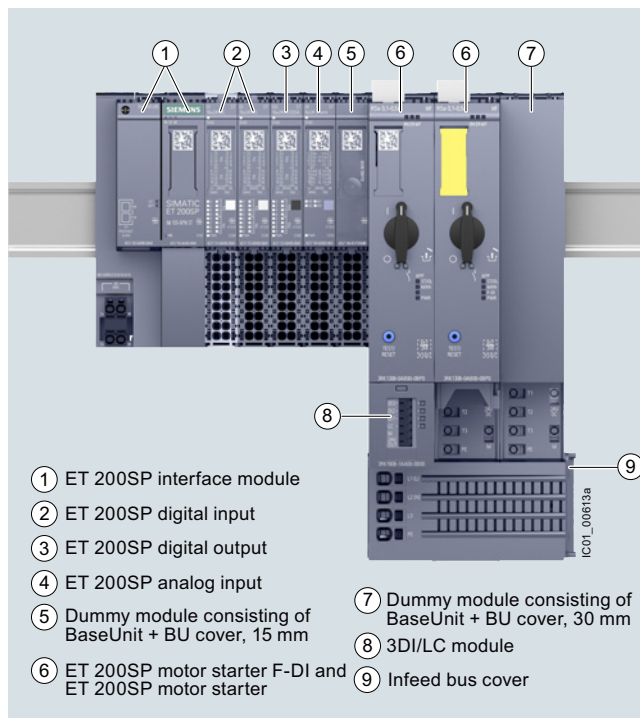

3RK1308 motor starter in the ET 200SP I/O system

More information

Homepage, see www.siemens.com/sirius-motor-starter-et200sp
Industry Mall, see www.siemens.com/product?3RK1308
TIA Selection Tool, see www.siemens.com/TST

Further components in the ET 200SP I/O system, see www.siemens.com/et200sp

ET 200SP motor starters

ET 200SP is a scalable and extremely flexible modular I/O system with IP20 degree of protection.

As I/O modules, the ET 200SP motor starters are an integral part of this I/O system. They are switching and protection devices for single- and three-phase loads and are available as direct-on-line or reversing starters.

Basic functionality

All versions of the ET 200SP motor starter feature the following functionality:

- Fully pre-wired motor starters for switching and protecting any AC loads up to 5.5 kW from 48 V AC to 500 V AC
- Disconnection possible via fail-safe motor starters up to SIL 3 and PL e Cat. 4
- With self-assembling 32 A power bus, i.e. the load voltage is only fed in once for a group of motor starters
- All control supply voltages connected only once, i.e. when modules are added they are automatically connected to the next module
- Hot swapping is permissible
- Digital inputs can optionally be used via a 3DI/LC module
- Control of the motor starter from the control system and diagnostics status via the cyclic process image
- Diagnostics capability for active monitoring of the switching and protection functions

- The signal states in the process image of the motor starter provide information about protective devices (short circuit or overload), the switching states of the motor starter, and system faults.

Starter Kit

The 3RK1908-1SK00 Starter Kit is a favorably priced complete package for switching and monitoring motors in the ET 200SP system, see [page 10/51](http://page.10/51).

It contains:

- a 3RK1308-0BC00-0CP0 reversing starter (0.9 to 3 A)
- a 3RK1908-0AP00-0AP0 BaseUnit with 500 V and 24 V AC/DC infeed
- an EMC distance module (consisting of 6ES7193-6BP00-0BA0 BaseUnit plus 6ES7133-6CV15-1AM0 BU cover 15 mm)

Use of fan

For motor starters with a 12 A rated current, the 3RW4928-8VB00 fan is included in the scope of supply.

This fan can also be ordered as an option for motor starters with lower rated currents, if the boundary conditions demand this. For information on the ambient conditions for the use of motor starters, see [chapter "Product overview" in the Equipment Manual](#).

Designing interference-free motor starters

For interference-free operation of the ET 200SP station in accordance with IEC 60947-4-2 standard, use a dummy module before the first motor starter. The dummy module consists of the 6ES7193-6BP00-0BA0 or 6ES7193-6BP00-0DA0 BaseUnit and the 6ES7133-6CV15-1AM0 BU cover 15 mm.

The 15 mm BU cover protects the plug contacts of the BaseUnit against dirt.

Electromechanical switching devices in series with hybrid motor starters

Switching an inductive load - in particular of motors <1 kW with high inductance - with an electromechanical switching device (e.g. contactor) can cause high and steep voltage edges.

The resulting faults/damage can be prevented by first disconnecting with the hybrid motor starter or by using EMC suppression modules:

- For 3RT2916-1P.. EMC suppression modules for direct mounting on the contactor, see <https://mall.industry.siemens.com/mall/en/WW/Catalog/Products/10047575>
- For motor suppression modules that are fitted in the main circuit, see page 10/51

Note:

For more information, see <https://support.industry.siemens.com/cs/ww/en/view/109758696>.

3DI/LC control module

This is a digital input module with three inputs for local motor starter functions such as "manual local control", "implementation of fast inputs" or "end position disconnection". For a list of all the functions permitted by the 3DI/LC module, see chapter "Overview of functions" in the Equipment Manual.

The module is plugged into the front of the motor starter from which it is supplied with a 24 V DC operating voltage.

BaseUnits for motor starters

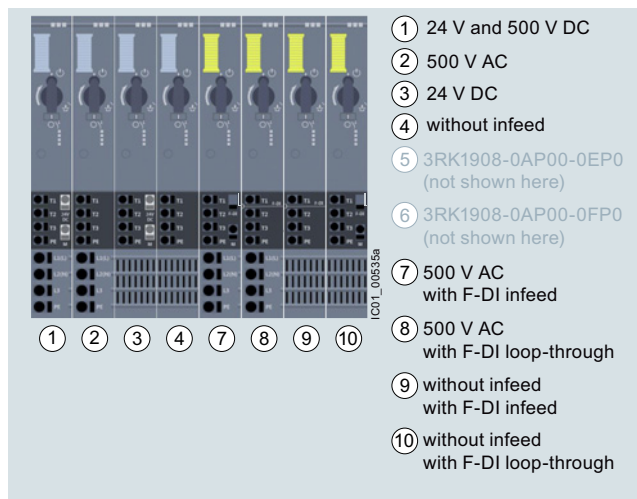

View of the BaseUnit infeeds for the motor starters

BaseUnits are components for accommodating the ET 200SP I/O modules.

The self-assembling voltage buses integrated into the BaseUnits reduce wiring outlay to the single infeed (both of auxiliary and load voltage).

All modules following on the right are automatically supplied upon plugging the BaseUnits together, if BaseUnits are inserted with routing.

The rugged design and keyed connection technology enables use in harsh industrial conditions.

The BaseUnits are available with various infeeds for the motor starters.

I/O systems

SIMATIC ET 200 systems for the control cabinet
SIMATIC ET 200SP

I/O modules > ET 200SP motor starters

Article No. scheme

Product versions		Article number	
Motor starters		3RK1308 - 0 <input type="checkbox"/> <input type="checkbox"/> 0 0 - 0 C P 0	
Product function	Direct-on-line starters	A	For motor standard output 0.09 ... 5.5 kW ¹⁾
	Reversing starters	B	For motor standard output 0.09 ... 5.5 kW ¹⁾
	Fail-safe direct-on-line starters	C	For motor standard output 0.09 ... 5.5 kW ¹⁾
	Fail-safe reversing starters	D	For motor standard output 0.09 ... 5.5 kW ¹⁾
Current range	0.1 ... 0.4 A	A	Maximum current-carrying capacity when starting 4 A
	0.3 ... 1 A	B	Maximum current-carrying capacity when starting 10 A
	0.9 ... 3 A	C	Maximum current-carrying capacity when starting 30 A
	2.8 ... 9 A	D	Maximum current-carrying capacity when starting 90 A
	4 ... 12 A	E	Including fan (3RW4928-8VB00), maximum current-carrying capacity when starting 100 A
Example		3RK1308 - 0 A D 0 0 - 0 C P 0	

¹⁾ For standard motors: Single- or three-phase asynchronous motors, single-phase asynchronous motors, single-phase asynchronous motors, at 400 V AC and 500 V AC; the actual startup characteristics of the motor as well as its rated data are important factors here.

Product versions		Article number	
BaseUnit		3RK1908 - 0 A P 0 0 - 0 <input type="checkbox"/> P 0	
BU infeed	24 V and 500 V AC	A	
	24 V DC	B	
	500 V AC	C	
	without infeed	D	
	500 V AC	G	with F-DI infeed
	500 V AC	H	with F-DI loop-through
	without infeed	J	with F-DI loop-through
	without infeed	K	with F-DI infeed
Example		3RK1908 - 0 A P 0 0 - 0 A P 0	

Note:

The article number schemes show an overview of product versions for better understanding of the logic behind the article numbers.

For your orders, please use the article numbers quoted in the selection and ordering data.

Benefits

Product advantages

The ET 200SP motor starters offer a number of advantages:

- Fully integrated into the ET 200SP I/O system (including TIA Selection Tool and TIA Portal)
- High degree of flexibility when it comes to safety applications via SIMATIC F-CPU or SIRIUS 3SK safety relays up to SIL 3 and PL e Cat. 4.
- Simple, integrated current value transmission
- Extensive parameterization by means of TIA Portal
- Increase of plant availability through fast replacement of units (easy mounting and plug-in technology)
- Greater endurance and reduced heat losses thanks to hybrid technology
- Less space required in the control cabinet (20 to 80%) as a result of greater functional density (direct-on-line and reversing starters in same width)
- Extensive diagnostics and information for preventive maintenance
- Parameterizable inputs via 3DI/LC control module
- Less wiring and testing required as a result of integrating several functions into a single device
- Lower overheads for stock keeping and configuration as a result of the wide setting range of the electronic overload release (up to 1:3)
- Technology has lower inherent power losses than speed-controlled drive systems, so that less cooling (and smaller footprint) are possible

- The ET 200SP motor starters can be used with highly energy-efficient IE3/IE4 motors, [see Application Manual](#). Take the current characteristics of the connected motor and motor starter into account when dimensioning. In addition to the rated current, the maximum permissible current range of the motor starter and the ratio of the rated current to the starting current of the motor are relevant.

Standards and approvals

- IEC/EN 60947-4-2
- UL 60947-4-2
- CSA
- ATEX
- IEC 61508-1: SIL 3
- ISO 13849: PL e
- CCC approval for China

Application

The ET 200SP motor starters are suitable for the following applications:

- Switching and monitoring of
 - Three-phase motors with overload and short-circuit protection (e.g. 400 V asynchronous motors for secondary drives in conveyor systems)
 - Single-phase motors with overload and short-circuit protection (e.g. 230 V motors for pump applications)
 - Resistive loads by means of current value and diagnostics via the maintenance function (e.g. for heaters)
- Plant monitoring and energy management in conveyor systems:
 - By means of the phase asymmetry and zero current detection during current measurement, for example, drive belt monitoring and blocking monitoring are possible.

- Track switching and lifting table control in conveyor systems: Track switches can be implemented using the quick stop function and lifting table controls by means of the "immediate end position disconnection" function without any laborious programming.
- Safe isolation of the drive from main power supply: The isolating functions according to IEC 60947-1 offer protection against inadvertent activation during plant maintenance.

Motor starters in the process industry

For the ET 200SP motor starters, special BaseUnits are available that enable the device to be used in the ET 200SP HA I/O system, too. This is typically used in process engineering applications.

Technical specifications**More information**

Industry Mall, see www.siemens.com/product?3RK1308

FAQs, see <https://support.industry.siemens.com/cs/ww/en/ps/21800/faq>

Equipment Manual, see <https://support.industry.siemens.com/cs/ww/en/view/109479973>

ET 200SP motor starters

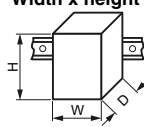
Article number	3RK1308-0AA00-0CP0	3RK1308-0AB00-0CP0	3RK1308-0AC00-0CP0	3RK1308-0AD00-0CP0	3RK1308-0AE00-0CP0	
	3RK1308-0BA00-0CP0	3RK1308-0BB00-0CP0	3RK1308-0BC00-0CP0	3RK1308-0BD00-0CP0	3RK1308-0BE00-0CP0	
Product category	Motor starters					
General technical specifications:						
Width x height x depth	mm	30 x 142 x 150				
						
Design of the switching contact		Hybrid				
Design of the motor protection		Electronic				
Installation altitude at height above sea level, maximum	m	4 000				
Mounting position		Vertical, horizontal, flat (observe derating)				
Type of mounting		Can be plugged into BaseUnit				
Ambient temperature						
• During operation	°C	-25 ... +60				
• During transport	°C	-40 ... +70				
• During storage	°C	-40 ... +70				
Relative humidity during operation	%	10 ... 95				
Vibration resistance		15 mm up to 6 Hz; 2 g up to 500 Hz				
Shock resistance		6 g / 11 ms				
Degree of protection		IP20				
Type of coordination		1				
Electrical data:						
Supply voltage at DC rated value	V	24				
Operational power for AC-53a at 400 V rated value	kW	0.12	0.25	1.1	4	5.5
Operating frequency, rated value	Hz	50 ... 60				
Ultimate short-circuit current breaking capacity (I_{cu})						
• at 400 V rated value	kA	55				
• at 500 V rated value	kA	55				
Adjustable current response value of the inverse-time delayed overload release	A	0.1 ... 0.4	0.3 ... 1	0.9 ... 3	2.8 ... 9	4 ... 12
Max. current carrying capacity at startup	A	4	10	30	90	100
Max. permissible voltage for protective separation between main and auxiliary circuit	V	500				
Insulation voltage, rated value	V	500				
Trip class		CLASS 5 and 10 adjustable				

I/O systems

SIMATIC ET 200 systems for the control cabinet
SIMATIC ET 200SP

I/O modules > ET 200SP motor starters**ET 200SP fail-safe motor starters**

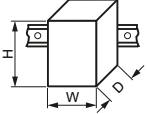
Article number		3RK1308-0CA00-0CP0	3RK1308-0CB00-0CP0	3RK1308-0CC00-0CP0	3RK1308-0CD00-0CP0	3RK1308-0CE00-0CP0
		3RK1308-0DA00-0CP0	3RK1308-0DB00-0CP0	3RK1308-0DC00-0CP0	3RK1308-0DD00-0CP0	3RK1308-0DE00-0CP0
Product category		Motor starters				
General technical specifications:						
Width x height x depth	mm	30 × 142 × 150				
						
Design of the switch contact		Hybrid				
Design of the motor protection		Electronic				
Installation altitude at height above sea level, maximum	m	2 000				
Mounting position		Vertical, horizontal, flat (observe derating)				
Type of mounting		Can be plugged into BaseUnit				
Ambient temperature						
• During operation	°C	-25 ... +60				
• During transport	°C	-40 ... +70				
• During storage	°C	-40 ... +70				
Relative humidity during operation	%	10 ... 95				
Vibration resistance		15 mm up to 6 Hz; 2 g up to 500 Hz				
Shock resistance		6 g / 11 ms				
Degree of protection		IP20				
Type of coordination		1				
Electrical data:						
Supply voltage at DC rated value	V	24				
Operational power for AC-53a at 400 V, rated value	kW	0.12	0.25	1.1	4	5.5
Operating frequency, rated value	Hz	50 ... 60				
Ultimate short-circuit current breaking capacity (I_{cu})						
• at 400 V rated value	kA	55				
• at 500 V rated value	kA	55				
Adjustable current response value of the inverse-time delayed overload release	A	0.1 ... 0.4	0.3 ... 1	0.9 ... 3	2.8 ... 9	4 ... 12
Max. current carrying capacity at startup	A	4	10	30	90	100
Max. permissible voltage for protective separation between main and auxiliary circuit	V	500				
Insulation voltage, rated value	V	500				
Trip class		CLASS 5 and 10 adjustable				

BaseUnits for motor starters

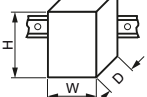
Article number	3RK1908-0AP00-0AP0	3RK1908-0AP00-0BP0	3RK1908-0AP00-0CP0	3RK1908-0AP00-0DP0	3RK1908-0AP00-0GP0	3RK1908-0AP00-0HP0	3RK1908-0AP00-0JP0	3RK1908-0AP00-0KP0
Product designation	BaseUnit							
General technical specifications:								
Width x height x depth	mm	30 × 215 × 75						
								
Ambient temperature								
• During operation	°C	-25 ... +60						
• During transport	°C	-40 ... +70						
• During storage	°C	-40 ... +70						
Degree of protection	IP20							
Touch protection against electric shock	Finger-safe							
Connections/terminals:								
Type of connectable conductor cross-sections								
• At the inputs for supply voltage								
- Solid		1 x 0.5 ... 2.5 mm ²	--					
- Finely stranded with end sleeve		1 x 0.5 ... 2.5 mm ²	--					
- Finely stranded without end sleeve		1 x 0.5 ... 2.5 mm ²	--					
- Solid for AWG cables		1 x 20 ... 12	--					
• For infeed								
- Solid		1 x 1 ... 6 mm ²	--	1 x 1 ... 6 mm ²	--	1 x 1 ... 6 mm ²	--	
- Finely stranded with end sleeve		1 x 1 ... 6 mm ²	--	1 x 1 ... 6 mm ²	--	1 x 1 ... 6 mm ²	--	
- Finely stranded without end sleeve		1 x 1 ... 6 mm ²	--	1 x 1 ... 6 mm ²	--	1 x 1 ... 6 mm ²	--	
- Solid for AWG cables		1 x 18 ... 10	--	1 x 18 ... 10	--	1 x 18 ... 10	--	
• For load-side outgoing feeder								
- Solid		1 x 0.5 ... 2.5 mm ²						
- Finely stranded with end sleeve		1 x 0.5 ... 2.5 mm ²						
- Finely stranded without end sleeve		1 x 0.5 ... 2.5 mm ²						
- Solid for AWG cables		1 x 20 ... 12						
Type of electrical connection for auxiliary and control circuits	Spring-loaded terminals (push-in)							
Miscellaneous:								
Type of screwdriver tip	Slotted							
Size of screwdriver tip	Standard screwdriver 0.6 mm x 3.5 mm							

I/O systems

SIMATIC ET 200 systems for the control cabinet
SIMATIC ET 200SP

I/O modules > ET 200SP motor starters**3DI/LC control module**

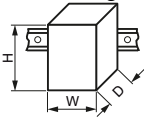
Article number	3RK1908-1AA00-0BP0	
Product designation	3DI/LC control module	
General technical specifications:		
Width x height x depth	mm	30 × 54.5 × 42.3
		
Type of product	Accessories	
Number of digital inputs	4	
Installation altitude at height above sea level, maximum	m	2 000
Mounting position	Vertical, horizontal, flat	
Type of mounting	Can be plugged onto motor starter	
Ambient temperature		
• During operation	°C	-25 ... +60
• During transport	°C	-40 ... +70
• During storage	°C	-40 ... +70
Connections/terminals:		
Connectable conductor cross-section for auxiliary contacts		
• Solid or stranded	mm ²	0.2 ... 1.5
• Finely stranded with end sleeve	mm ²	0.25 ... 1.5
• Finely stranded without end sleeve	mm ²	0.2 ... 1.5
AWG number as coded connectable conductor cross-section	24 ... 16	
Type of electrical connection for auxiliary and control circuits	Spring-loaded terminals (push-in)	
Electrical data:		
Type of voltage of the control supply voltage	DC	
Control supply voltage at DC rated value	V	20.4 ... 28.8
Miscellaneous:		
Type of screwdriver tip	Slotted	
Size of screwdriver tip	Standard screwdriver 0.6 mm x 3.5 mm	

Selection and ordering data

Adjustable current response value of the inverse-time delayed overload release	Max. current carrying capacity at startup	Article No.
A	A	

Motor starters

Direct-on-line starters



3RK1308-0AB00-0CP0

0.1 ... 0.4	4	NEW	3RK1308-0AA00-0CP0 3RK1308-0AB00-0CP0 3RK1308-0AC00-0CP0 3RK1308-0AD00-0CP0 3RK1308-0AE00-0CP0
0.3 ... 1	10		
0.9 ... 3	30		
2.8 ... 9	90		
4 ... 12	100		

Reversing starters



3RK1308-0BB00-0CP0

0.1 ... 0.4	4	NEW	3RK1308-0BA00-0CP0 3RK1308-0BB00-0CP0 3RK1308-0BC00-0CP0 3RK1308-0BD00-0CP0 3RK1308-0BE00-0CP0
0.3 ... 1	10		
0.9 ... 3	30		
2.8 ... 9	90		
4 ... 12	100		

Fail-safe direct-on-line starters



3RK1308-0CE00-0CP0

0.1 ... 0.4	4	NEW	3RK1308-0CA00-0CP0 3RK1308-0CB00-0CP0 3RK1308-0CC00-0CP0 3RK1308-0CD00-0CP0 3RK1308-0CE00-0CP0
0.3 ... 1	10		
0.9 ... 3	30		
2.8 ... 9	90		
4 ... 12	100		

Fail-safe reversing starters



3RK1308-0DE00-0CP0

0.1 ... 0.4	4	NEW	3RK1308-0DA00-0CP0 3RK1308-0DB00-0CP0 3RK1308-0DC00-0CP0 3RK1308-0DD00-0CP0 3RK1308-0DE00-0CP0
0.3 ... 1	10		
0.9 ... 3	30		
2.8 ... 9	90		
4 ... 12	100		

I/O systems

SIMATIC ET 200 systems for the control cabinet
SIMATIC ET 200SP

I/O modules > ET 200SP motor starters

Type of product	Operational voltage of the AC infeed	Supply voltage of the DC infeed	Push-in terminals 
	V	V	Article No.

BaseUnits¹⁾



3RK1908-0AP00-0AP0

For motor starters

• with AC/DC infeed	500	24	3RK1908-0AP00-0AP0
• with DC infeed	--	24	3RK1908-0AP00-0BP0
• with AC infeed	500	--	3RK1908-0AP00-0CP0
• without infeed	--	--	3RK1908-0AP00-0DP0

For fail-safe motor starters **NEW**

• with AC infeed, with F-DI infeed for fail-safe motor starters	500	--	3RK1908-0AP00-0GP0
• with AC infeed, with F-DI loop-through for fail-safe motor starters	500	--	3RK1908-0AP00-0HP0
• without AC/DC infeed, with F-DI loop-through for fail-safe motor starters	--	--	3RK1908-0AP00-0JP0
• without AC/DC infeed, with F-DI infeed for fail-safe motor starters	--	--	3RK1908-0AP00-0KP0

¹⁾ The voltage is looped-through from BaseUnits with infeed to subsequent BaseUnits without infeed.

Type of product	Supply voltage at DC rated value	Loop through the potential group from the left	Push-in terminals 
	V		Article No.

BaseUnits



6ES7193-6BP00-0BA0

For dummy modules

• dark, looping through the potential group	24	Yes	6ES7193-6BP00-0BA0
• light, opening a new potential group	24	No	6ES7193-6BP00-0DA0

Control supply voltage at DC rated value	Product function		Push-in terminals 
	Local control	Digital inputs parameterizable	Article No.
V			

3DI/LC control module



3RK1908-1AA00-0BP0

20.4 ... 28.8	Yes	Yes	3RK1908-1AA00-0BP0
---------------	-----	-----	---------------------------

10

	Product designation	Type of product	Article No.
Accessories			
	BU cover 15 mm	for BaseUnits Type A0 or A1	6ES7133-6CV15-1AM0
6ES7133-6CV15-1AM0			
	BU cover 30 mm	For protection of empty slots, 30 mm	3RK1908-1CA00-0BP0
3RK1908-1CA00-0BP0			
	Infeed bus cover (1 bag containing 10 covers)	For ET 200SP	3RK1908-1DA00-2BP0
3RK1908-1DA00-2BP0			
	Mechanical bracket (1 bag containing 5 mechanical brackets)	Mechanical, for ET 200SP	3RK1908-1EA00-1BP0
3RK1908-1EA00-1BP0			
	Fan	Can be used for 3RK1308	3RW4928-8VB00
3RW4928-8VB00			
	Motor suppression module • Square		3RK1911-6EA00
3RK1911-6EA00			
	• Round		3RK1911-6EB00
3RK1911-6EB00			
	Starter Kit NEW	consists of 3RK1308-0BC00-0CP0 reversing starter (0.9 ... 3 A), 3RK1908-0AP00-0AP0 BaseUnit with 500 V and 24 V AC/DC infeed, and EMC distance module (consisting of 6ES7193-6BP00-0BA0 BaseUnit plus 6ES7133-6CV15-1AM0 BU cover 15 mm)	3RK1908-1SK00
3RK1908-1SK00			

I/O systems

SIMATIC ET 200 systems for the control cabinet
SIMATIC ET 200SP

Accessories > SIPLUS server module

Overview

The SIPLUS server module is included in the scope of supply of all head-end stations (interface module, CPU, Open Controller). It concludes the setup of a SIPLUS ET 200SP station.

Technical specifications

Article number	6AG1193-6PA00-7AA0
Based on	6ES7193-6PA00-0AA0 SIPLUS ET 200SP Servermodul

General information	
Product type designation	Server module

Ambient conditions	
Ambient temperature during operation	
• min.	-40 °C; = Tmin (incl. condensation/frost)
• max.	70 °C; = Tmax

Altitude during operation relating to sea level	
• Installation altitude above sea level, max.	5 000 m
• Ambient air temperature-barometric pressure-altitude	Tmin ... Tmax at 1 140 hPa ... 795 hPa (-1 000 m ... +2 000 m) // Tmin ... (Tmax - 10 K) at 795 hPa ... 658 hPa (+2 000 m ... +3 500 m) // Tmin ... (Tmax -20 K) at 658 hPa ... 540 hPa (+3 500 m ... +5 000 m)

Relative humidity	
• With condensation, tested in accordance with IEC 60068-2-38, max.	100 %; RH incl. condensation / frost (no commissioning in bedewed state), horizontal installation

Resistance	
-------------------	--

Coolants and lubricants	
- Resistant to commercially available coolants and lubricants	Yes; Incl. diesel and oil droplets in the air

Use in stationary industrial systems	
- to biologically active substances according to EN 60721-3-3	Yes; Class 3B2 mold, fungus and dry rot spores (with the exception of fauna); Class 3B3 on request
- to chemically active substances according to EN 60721-3-3	Yes; Class 3C4 (RH < 75 %) incl. salt spray acc. to EN 60068-2-52 (severity degree 3); *
- to mechanically active substances according to EN 60721-3-3	Yes; Class 3S4 incl. sand, dust, *
- Against mechanical environmental conditions acc. to EN 60721-3-3	Yes; Class 3M8 using the SIPLUS Mounting Kit ET 200SP (6AG1193-6AA00-0AA0)

Article number	6AG1193-6PA00-7AA0
Based on	6ES7193-6PA00-0AA0 SIPLUS ET 200SP Servermodul

Use on ships/at sea	
- to biologically active substances according to EN 60721-3-6	Yes; Class 6B2 mold and fungal spores (excluding fauna); Class 6B3 on request
- to chemically active substances according to EN 60721-3-6	Yes; Class 6C3 (RH < 75 %) incl. salt spray acc. to EN 60068-2-52 (severity degree 3); *
- to mechanically active substances according to EN 60721-3-6	Yes; Class 6S3 incl. sand, dust; *
- Against mechanical environmental conditions acc. to EN 60721-3-6	Yes; Class 6M4 using the SIPLUS Mounting Kit ET 200SP (6AG1193-6AA00-0AA0)

Usage in industrial process technology	
- Against chemically active substances acc. to EN 60654-4	Yes; Class 3 (excluding trichlorethylene)
- Environmental conditions for process, measuring and control systems acc. to ANSI/ISA-71.04	Yes; Level GX group A/B (excluding trichlorethylene; harmful gas concentrations up to the limits of EN 60721-3-3 class 3C4 permissible); level LC3 (salt spray) and level LB3 (oil)

Remark	
- Note regarding classification of environmental conditions acc. to EN 60721, EN 60654-4 and ANSI/ISA-71.04	* The supplied plug covers must remain in place over the unused interfaces during operation!

Conformal coating	
• Coatings for printed circuit board assemblies acc. to EN 61086	Yes; Class 2 for high availability
• Protection against fouling acc. to EN 60664-3	Yes; Type 1 protection
• Military testing according to MIL-I-46058C, Amendment 7	Yes; Discoloration of coating possible during service life
• Qualification and Performance of Electrical Insulating Compound for Printed Board Assemblies according to IPC-CC-830A	Yes; Conformal coating, Class A

Ordering data

Article No.

SIPLUS server module	6AG1193-6PA00-7AA0
(Extended temperature range and exposure to media)	
Spare part	

Overview



ET 200SP HA, station with 2 redundant interface modules

Compact design, flexible connection possibilities and high system availability with redundant PROFINET connections: the SIMATIC ET 200SP HA distributed I/O system is perfectly suited to the requirements of the process industry. The new design allows up to 56 I/O modules per station. An impressively high concentration of up to 32 channels on a module that is only 22.5 mm wide allows for maximum economy in the control cabinet.

Redundant PROFINET connections allow the connection of high-availability controllers via two independent networks, with a choice of copper or fiber-optic cables. The system can be scaled and extended in small steps using a variety of available modules, for example with digital and analog I/Os as well as NAMUR, HART, and other protocols. All 24 V standard signals are connected via an identical terminal block type, which allows a high degree of standardization for the control cabinets.

SIMATIC ET 200SP HA is designed for use in the control cabinet as well as for hazardous areas up to Ex zone 2. The extended temperature range from -40 to +70 °C and the conformal coating of all components allow direct installation in the field.

You also benefit in engineering from seamless integration in SIMATIC PCS 7. The SIMATIC ET 200SP HA in combination with the Advanced Process Library also offers flexible and simple online parameter assignment and selection of up to four HART variables per channel.

I/O systems

SIMATIC ET 200 systems for the control cabinet
SIMATIC ET 200SP HA

Interface module

Overview



IM 155-6 PN HA

IM 155-6 PN HA interface module

The IM 155-6 PN HA together with the IM carrier module and the BusAdapter forms the interface of the ET 200SP HA. The interface is used for communication between the CPU and the connected ET 200SP HA I/O modules over PROFINET.

Technical specifications

Article number	6DL1155-6AU00-0PM0 ET 200SP HA, IM155-6 PN
General information	
Product type designation	IM 155-6 PN
Product function	
• I&M data	Yes; I&M0 to I&M3
Engineering with	
• PCS 7 configurable/integrated as of version	V9.0
Supply voltage	
Rated value (DC)	24 V
Reverse polarity protection	Yes
Short-circuit protection	Yes
Address area	
Address space per station	
• Address space per station, max.	1 440 byte; 1 440 bytes R1 and S1 without CiR, otherwise 1 000 bytes
Hardware configuration	
Integrated power supply	Yes; 24 V DC
Rack	
• Modules per rack, max.	56; 56 slots for I/O modules + server module (width without IM ≤ 1.3 m)
Time stamping	
Accuracy	1 ms; In compliance with the supplementary conditions described in the Equipment Manual
Interfaces	
Number of PROFINET interfaces	1; 2 ports (switch)
1. Interface	
Interface types	
• Number of ports	2; via BusAdapter
• integrated switch	Yes
• BusAdapter (PROFINET)	Yes; Compatible BusAdapters: BA 2x RJ45, BA 2x FC, BA 2x LC, BA LC/RJ45, BA LC/FC, BA VD
Protocols	
• PROFINET IO Device	Yes
• Open IE communication	Yes
• Media redundancy	Yes; as MRP client

Article number	6DL1155-6AU00-0PM0 ET 200SP HA, IM155-6 PN
Interface types	
RJ 45 (Ethernet)	
• Transmission procedure	PROFINET with 100 Mbit/s full duplex (100BASE-TX)
• 100 Mbps	Yes; PROFINET with 100 Mbit/s full duplex (100BASE-TX)
• Autonegotiation	Yes
• Autocrossing	Yes
Protocols	
PROFINET IO Device Services	
- Open IE communication	Yes
Redundancy mode	
• MRP	Yes
• PROFINET system redundancy (S2)	Yes; S2, R1
Open IE communication	
• TCP/IP	Yes
• SNMP	Yes
• LLDP	Yes
Interrupts/diagnostics/status information	
Status indicator	Yes
Alarms	Yes
Diagnostics function	Yes
Diagnostics indication LED	
• RUN LED	Yes; green LED
• ERROR LED	Yes; red LED
• MAINT LED	Yes; Yellow LED
• ACT LED	Yes; green LED
• Monitoring of the supply voltage (PWR-LED)	Yes; green PWR LED
• Connection display LINK TX/RX	Yes; 2x green link LEDs on BusAdapter

Technical specifications		Ordering data	Article No.
Article number	6DL1155-6AU00-0PM0 ET 200SP HA, IM155-6 PN	Interface module	
Ambient conditions		PROFINET IM 155-6 PN interface module Max. 56 I/O modules, multi hot swap, no server module	6DL1155-6AU00-0PM0
Ambient temperature during operation		Accessories	
• horizontal installation, min.	-40 °C	IM cover Slot cover for interface module slots, to protect vacant slots Width 50 mm, 5 units	6DL1133-6CV50-0AM0
• horizontal installation, max.	70 °C		
• vertical installation, min.	-40 °C		
• vertical installation, max.	60 °C		
Dimensions			
Width	50 mm		
Height	138 mm		
Depth	89 mm		
Weights			
Weight, approx.	192 g; without BusAdapter		

I/O systems

SIMATIC ET 200 systems for the control cabinet
SIMATIC ET 200SP HA

Digital I/O modules

Overview



- DI 16×24VDC HA digital input module
Sixteen 24 V DC digital inputs
- DI 32 × 24VDC HA digital input module
Thirty-two 24 V DC digital inputs
- DI 16×NAMUR HA digital input module
Sixteen NAMUR digital inputs
- DI 8×24...125VDC HA digital input module
Eight 24 to 125 V DC digital inputs
- DI 8×230VAC HA digital input module
Eight 230 V AC digital inputs
- DQ 16×24VDC/0.5A HA digital output module
Sixteen 24 V DC digital outputs, 0.5 A
- DQ 32×24VDC/0.5A HA digital output module
Thirty-two 24 V DC digital outputs, 0.5 A
- RQ 4×120VDC-230VAC/5 A CO HA digital output module
Four 24 to 120 V DC, 24 to 230 V AC relay outputs, 5 A

Technical specifications

Article number	6DL1131-6GF00-0PK0	6DL1131-6BH00-0PH1	6DL1131-6BL00-0PH1	6DL1131-6DF00-0PK0	6DL1131-6TH00-0PH1
	ET 200SP HA, DI 8X230VAC	ET 200SP HA, DI 16X24VDC	ET 200SP HA, DI 32X24VDC	ET 200SP HA, DI 8X24 ... 125VDC	ET 200SP HA, DI 16XNAMUR
General information					
Product type designation	DI 8x230VAC HA	DI 16x24VDC HA	DI 32x24VDC HA	DI 8x24 ... 125 V DC HA	DI 16xNAMUR HA
Engineering with					
• PCS 7 configurable/integrated as of version	V9.0	V9.0	V9.0	V9.0	V9.0
Operating mode					
• DI	Yes	Yes	Yes	Yes	Yes
• Counter		No	No	No	No
• Oversampling		No	No	No	
• MSI		No	No	No	
Supply voltage					
Rated value (DC)		24 V	24 V	24 V	24 V
Rated value (AC)	230 V				
Reverse polarity protection		Yes	Yes	Yes	Yes
Encoder supply					
Number of outputs		16	32; When terminal block with encoder supply is used (type P0)		16
Short-circuit protection		Yes; electronic (response threshold 0.7 A to 1.3 A; for IO redundancy up to 2.6 A) Ensure sufficient low-resistance cable routing to the sensor/actuator in order to attain the response threshold. Depending on the cable cross-section used, there may be constraints regarding the usable length of cable	Yes; When using TB type P0		Yes
Output current					
• up to 60 °C, max.		2 A; 1 A when mounted vertically; see derating information in Equipment Manual			
• up to 70 °C, max.		1 A; See derating information in Equipment Manual			

Technical specifications

Article number	6DL1131-6GF00-0PK0 ET 200SP HA, DI 8X230VAC	6DL1131-6BH00-0PH1 ET 200SP HA, DI 16X24VDC	6DL1131-6BL00-0PH1 ET 200SP HA, DI 32X24VDC	6DL1131-6DF00-0PK0 ET 200SP HA, DI 8X24 ... 125VDC	6DL1131-6TH00-0PH1 ET 200SP HA, DI 16XNAMUR
24 V encoder supply					
<ul style="list-style-type: none"> • 24 V • Short-circuit protection 		Yes Yes; electronic (response threshold 0.7 A to 1.3 A; for IO redundancy up to 2.6 A) Ensure sufficient low-resistance cable routing to the sensor/actuator in order to attain the response threshold. Depending on the cable cross-section used, there may be constraints regarding the usable length of cable			
<ul style="list-style-type: none"> • Output current per channel, max. • Output current per module, max. 		0.5 A			
		2 A			
Digital inputs					
Number of digital inputs	8; Isolated	16	32	8	16; NAMUR
Digital inputs, parameterizable		Yes	Yes		Yes
Source/sink input		Yes; P-reading	Yes; P-reading	Yes; P-reading	
Input characteristic curve in accordance with IEC 61131, type 1		Yes	Yes	Yes	
Input characteristic curve in accordance with IEC 61131, type 2		No	No		
Input characteristic curve in accordance with IEC 61131, type 3	Yes	Yes	Yes	Yes	
Pulse extension		Yes	No		Yes; 0.5 s, 1 s, 2 s
<ul style="list-style-type: none"> • Length 		off, 50 ms, 100 ms, 200 ms, 500 ms, 1 s, 2 s			
Time stamping		Yes; Resolution 10 ms		Yes; Resolution 10 ms	Yes
Time stamp (with precision of 1 ms)		Yes; Resolution 1ms		Yes; Resolution 1ms	No
Edge evaluation		Yes; rising edge, falling edge, edge change	Yes; rising edge, falling edge, edge change		Yes; rising edge, falling edge, edge change
Signal change flutter					Yes; 2 to 32 signal changes
Flutter observation window					Yes; 0.5 s, 1 s to 100 s in 1-s steps
Input voltage					
<ul style="list-style-type: none"> • Rated value (DC) • Rated value (AC) • for signal *0* • for signal *1* 	230 V	24 V	24 V		8.2 V
	0V AC to 40V AC	-30 to +5V	-30 to +5V	-125 ... +5 V	
	74 V AC to 264 V AC	+11 to +30V	+11 to +30V	+11 ... +125 V	
Input current					
<ul style="list-style-type: none"> • for signal *1*, typ. 	10.8 mA	2.5 mA	2.5 mA	3.1 mA	
for 10 k switched contact					
- for signal *0*					0.35 to 1.2 mA
- for signal *1*					2.1 ... 6.4 mA
for unswitched contact					
- for signal *0*, max. (permissible quiescent current)					0.5 mA
- for signal *1*					typ. 8 mA
for NAMUR encoders					
- for signal *0*					0.35 to 1.2 mA
- for signal *1*					2.1 ... 6.4 mA

I/O systems

SIMATIC ET 200 systems for the control cabinet
SIMATIC ET 200SP HA

Digital I/O modules

Technical specifications

Article number	6DL1131-6GF00-0PK0	6DL1131-6BH00-0PH1	6DL1131-6BL00-0PH1	6DL1131-6DF00-0PK0	6DL1131-6TH00-0PH1
	ET 200SP HA, DI 8X230VAC	ET 200SP HA, DI 16X24VDC	ET 200SP HA, DI 32X24VDC	ET 200SP HA, DI 8X24 ... 125VDC	ET 200SP HA, DI 16XNAMUR
Input delay (for rated value of input voltage)					
<ul style="list-style-type: none"> tolerated changeover time for changeover contacts 					300 ms
for standard inputs					
- parameterizable		Yes; none / 0.05 / 0.1 / 0.4 / 0.8 / 1.6 / 3.2 / 12.8 / 20 ms	No	Yes; 0.05 / 0.1 / 0.4 / 0.8 / 1.6 / 3.2 / 12.8 / 20 ms (in each case + delay of 30 to 500 µs, depending on line length)	
Encoder					
Connectable encoders					
<ul style="list-style-type: none"> NAMUR encoder/changeover contact according to EN 60947 Single contact / changeover contact unconnected Single contact / changeover contact connected with 10 kΩ 2-wire sensor - permissible quiescent current (2-wire sensor), max. 	Yes	Yes 1.5 mA	Yes 1.5 mA	Yes 1.5 mA	Yes Yes Yes Yes; Acc. to NAMUR 1.2 mA
Interrupts/diagnostics/ status information					
Diagnostics function		Yes	Yes		
Alarms					
<ul style="list-style-type: none"> Diagnostic alarm Hardware interrupt 	Yes	Yes; channel by channel Yes; channel by channel	Yes; channel by channel Yes; channel by channel	Yes Yes; Parameterizable, channels 0 to 7, rising/falling edge	Yes; channel by channel Yes; Parameterizable, channels 0 to 15, rising/falling edge
Diagnostic messages					
<ul style="list-style-type: none"> Diagnostic information readable Monitoring the supply voltage - parameterizable Monitoring of encoder power supply Wire-break Short-circuit Short-circuit to M Group error Changeover contact error 	Yes	Yes Yes; Module-wise Yes Yes Yes; Channel-by-channel, optional protective circuit for preventing wire-break diagnostics in the case of simple encoder contacts: 15 kOhm to 18 kOhm Yes; Encoder supply to M, channel by channel	Yes Yes; Module-wise Yes Yes; Channel-by-channel, optional protective circuit for preventing wire-break diagnostics in the case of simple encoder contacts: 15 kOhm to 18 kOhm No	Yes Yes Yes Yes; channel by channel	Yes Yes Yes Yes Yes Yes
Diagnostics indication LED					
<ul style="list-style-type: none"> MAINT LED Monitoring of the supply voltage (PWR-LED) Channel status display for channel diagnostics for module diagnostics 	Yes; Yellow LED Yes; green LED Yes; green/red DIAG LED	Yes; Yellow LED Yes; green PWR LED Yes; green LED Yes; red LED Yes; Green/red LED	Yes; Yellow LED Yes; green PWR LED Yes; green LED No Yes; green/red DIAG LED	Yes; Yellow LED Yes; green PWR LED Yes; green LED Yes; red LED Yes; green/red DIAG LED	Yes; Yellow LED Yes; green PWR LED Yes; green LED Yes; red LED Yes; green/red DIAG LED
Potential separation					
Potential separation channels					
<ul style="list-style-type: none"> between the channels and backplane bus Between the channels and load voltage L+ 	Yes	Yes	Yes	Yes	Yes Yes

Technical specifications

Article number	6DL1131-6GF00-0PK0 ET 200SP HA, DI 8X230VAC	6DL1131-6BH00-0PH1 ET 200SP HA, DI 16X24VDC	6DL1131-6BL00-0PH1 ET 200SP HA, DI 32X24VDC	6DL1131-6DF00-0PK0 ET 200SP HA, DI 8X24 ... 125VDC	6DL1131-6TH00-0PH1 ET 200SP HA, DI 16XNAMUR
Ambient conditions					
Ambient temperature during operation					
• horizontal installation, min.	-40 °C	-40 °C	-40 °C	-40 °C	-40 °C
• horizontal installation, max.	70 °C	70 °C	70 °C	70 °C	70 °C
• vertical installation, min.	-40 °C	-40 °C	-40 °C	-40 °C	-40 °C
• vertical installation, max.	60 °C	60 °C	60 °C	60 °C	60 °C
Dimensions					
Width	22.5 mm	22.5 mm	22.5 mm	22.5 mm	22.5 mm
Height	115 mm	115 mm	115 mm	115 mm	115 mm
Depth	138 mm	138 mm	138 mm	138 mm	138 mm
Weights					
Weight, approx.	148 g	135 g	150 g	165 g	153 g
Article number	6DL1132-6BH00-0PH1 ET 200SP HA, DQ 16X24VDC/0,5A		6DL1132-6BL00-0PH1 ET 200SP HA, DQ 32X24VDC/0,5A		6DL1132-6HD50-0PK0 ET 200SP HA, RQ 4X120VDC-230VAC/5A CO
General information					
Product type designation	DQ 16x24VDC/0.5A HA		DQ 32x24VDC/0.5A HA		RQ 4x120 V UC ... 230 V AC/ 5 A CO HA
Engineering with					
• PCS 7 configurable/integrated as of version	V9.0		V9.0		V9.0
Operating mode					
• DQ	Yes		Yes		
• DQ with energy-saving function	No		No		
• PWM	No		No		
• Oversampling	No		No		
• MSO	No		No		
Supply voltage					
Rated value (DC)	24 V		24 V		24 V
Reverse polarity protection	Yes		Yes		Yes
Digital outputs					
Number of digital outputs	16		32		4
Current-sinking	No		No		
Current-sourcing	Yes		Yes		
Digital outputs, parameterizable	Yes		Yes		
Short-circuit protection	Yes; Ensure sufficient low-resistance cable routing to the sensor/actuator in order to attain the response threshold. Depending on the cable cross-section used, there may be constraints regarding the usable length of cable.		Yes; Clocked electronically		
Open-circuit detection	Yes; 0.7 mA test current for wire-break diagnostics; this value is doubled in the case of IO redundancy		No		
Overload protection	Yes		Yes		
Limitation of inductive shutdown voltage to	L+ (-37 to 41V)		Typ. L+ (-53 V)		
Controlling a digital input	Yes		Yes		
Switching capacity of the outputs					
• with resistive load, max.	0.5 A		0.5 A		
• on lamp load, max.	5 W		5 W		
Load resistance range					
• lower limit	48 Ω		48 Ω		
• upper limit	12 kΩ		4 kΩ		

I/O systemsSIMATIC ET 200 systems for the control cabinet
SIMATIC ET 200SP HA**Digital I/O modules****Technical specifications**

Article number	6DL1132-6BH00-0PH1 ET 200SP HA, DQ 16X24VDC/0,5A	6DL1132-6BL00-0PH1 ET 200SP HA, DQ 32X24VDC/0,5A	6DL1132-6HD50-0PK0 ET 200SP HA, RQ 4X120VDC-230VAC/5A CO
Output current			
• for signal "1" rated value	0.5 A	0.5 A	
• for signal "0" residual current, max.	0.7 mA; Test current for wire-break diagnostics; this value is doubled in the case of IO redundancy	0.1 mA	
Output delay with resistive load			
• "0" to "1", typ.	50 µs	54 µs	
• "1" to "0", typ.	100 µs	48 µs	
Parallel switching of two outputs			
• for uprating	No	No	
• for redundant control of a load	Yes	Yes; only outputs of the same group	
Switching frequency			
• with resistive load, max.	100 Hz	100 Hz	2 Hz
• with inductive load, max.	2 Hz	2 Hz	0.5 Hz
• on lamp load, max.	10 Hz	10 Hz	2 Hz
Total current of the outputs			
• Current per channel, max.	0.5 A	0.5 A	
• Current per module, max.	8 A	10 A	
Total current of the outputs (per module)			
horizontal installation			
- up to 30 °C, max.	8 A		
- up to 40 °C, max.	8 A		
- up to 50 °C, max.	8 A		
- up to 60 °C, max.	5.5 A		
- up to 70 °C, max.	3 A	10 A	
vertical installation			
- up to 30 °C, max.	8 A		
- up to 40 °C, max.	6.33 A		
- up to 50 °C, max.	4.67 A		
- up to 60 °C, max.	3 A	10 A	
Relay outputs			
• Number of relay outputs			4
• external protection for relay outputs			yes; 6 A, see data in manual
Switching capacity of contacts			
- with inductive load, max.			2 A; 2 A (24 V DC), 0.5 A (60 V DC), 0.1 A (120 V DC)
- with resistive load, max.			5 A; 5 A (30 V DC), 5 A (230 V AC)
- Switching current, min.			8 mA
- Rated switching voltage (DC)			24 V; 24 V DC to 120 V DC
- Rated switching voltage (AC)			230 V; 24V AC to 230V AC
Cable length			
• shielded, max.	1 000 m	1 000 m	1 000 m
• unshielded, max.	600 m	600 m	200 m
Interrupts/diagnostics/status information			
Diagnostics function	Yes	Yes	Yes
Substitute values connectable	Yes	Yes	Yes
Alarms			
• Diagnostic alarm	Yes	Yes	Yes

Technical specifications

Article number	6DL1132-6BH00-0PH1 ET 200SP HA, DQ 16X24VDC/0,5A	6DL1132-6BL00-0PH1 ET 200SP HA, DQ 32X24VDC/0,5A	6DL1132-6HD50-0PK0 ET 200SP HA, RQ 4X120VDC-230VAC/5A CO
Diagnostic messages			
• Monitoring the supply voltage - parameterizable	Yes	Yes	Yes
• Wire-break	Yes; channel by channel	No	Yes
• Short-circuit		Yes	
• Short-circuit to M	Yes; channel by channel	Yes; channel by channel	
• Short-circuit to L+	Yes; channel by channel	No	
• Group error	Yes	Yes	
Diagnostics indication LED			
• MAINT LED	Yes; Yellow LED	Yes; Yellow LED	Yes; Yellow LED
• Monitoring of the supply voltage (PWR-LED)	Yes; green PWR LED	Yes; green PWR LED	Yes; green PWR LED
• Channel status display	Yes; green LED	Yes; green LED	Yes; green LED
• for channel diagnostics	Yes; red LED	No	
• for module diagnostics	Yes; green/red DIAG LED	Yes; green/red DIAG LED	Yes; green/red DIAG LED
Potential separation			
Potential separation channels			
• between the channels and backplane bus	Yes	Yes	Yes
Ambient conditions			
Ambient temperature during operation			
• horizontal installation, min.	-40 °C	-40 °C	-40 °C; No icing
• horizontal installation, max.	70 °C	70 °C	70 °C
• vertical installation, min.	-40 °C	-40 °C	-40 °C; No icing
• vertical installation, max.	60 °C	60 °C	60 °C
Altitude during operation relating to sea level			3 000 m due to converter type used
Dimensions			
Width	22.5 mm	22.5 mm	22.5 mm
Height	115 mm	115 mm	115 mm
Depth	138 mm	138 mm	138 mm
Weights			
Weight, approx.	137 g	150 g	162 g

I/O systemsSIMATIC ET 200 systems for the control cabinet
SIMATIC ET 200SP HA**Digital I/O modules****Ordering data****Article No.**

DI 16×24 V DC HA digital input module Sixteen 24 V DC digital inputs, color code CC01, for terminal block type H1 and M1, channel diagnostics	6DL1131-6BH00-0PH1
DI 32×24 V DC HA digital input module Thirty-two 24 V DC digital inputs, color code CC00, for terminal block type P0 and H1, channel diagnostics	6DL1131-6BL00-0PH1
DI 16×NAMUR HA digital input module Sixteen NAMUR digital inputs, color code CC01, for terminal block type H1 and M1, channel diagnostics	6DL1131-6TH00-0PH1
DI 8×24 to 125 V DC HA digital input module Eight 24 to 125 V DC digital inputs, color code CC42, for terminal block type K0, channel diagnostics	6DL1131-6DF00-0PK0
DI 8×230 V AC HA digital input module Eight 230 V AC digital inputs, color code CC42, for terminal block type K0, module diagnostics	6DL1131-6GF00-0PK0
DQ 16×24 V DC/0.5A HA digital output module Sixteen 24 V DC digital outputs, 0.5 A, color code CC02, for terminal block type H1 and M1, channel diagnostics	6DL1132-6BH00-0PH1
DQ 32×24 V DC/0.5 A HA digital output module Thirty-two 24 V DC digital outputs, 0.5 A, color code CC00, for terminal block type N0 and H1, channel diagnostics	6DL1132-6BL00-0PH1
RQ 4×120 V DC-230 V AC/5A CO HA digital output module Four 24 to 120 V DC, 24 to 230 V AC relay outputs, 5 A, color code CC40, for terminal block type K0, module diagnostics	6DL1132-6HD50-0PK0

Article No.**Accessories****Labeling strips**

For labeling the I/O modules

- Roll, light gray (with a total of 500 labeling strips), 1 unit
- A4 sheets, light gray (with a total of 1 000 labeling strips), 10 units

6DL1193-6LR00-0AA0**6DL1193-6LA00-0AA0****Color-coding labels**

For push-in terminals

- Color code CC01, 10 units gray (terminals 1 to 16), red (terminals 17 to 32)
- Color code CC02, 10 units gray (terminals 1 to 16), blue (terminals 17 to 32)
- Color code CC40, 10 units gray (terminals 1 to 16)
- Color code CC42, 10 units gray (terminals 1 to 8), blue (terminals 9 to 16)

6DL1193-6CP01-2HH1**6DL1193-6CP02-2HH1****6DL1193-6CP40-2HK0****6DL1193-6CP42-2HK0****Equipment labeling plates**

10 sheets with 16 plates each

6ES7193-6LF30-0AW0**PM cover**Slot cover for I/O modules, to protect vacant I/O slots
Width 22.5 mm, 5 units**6DL1133-6CV22-0AM0**

Overview



- AI 16xI 2-wire HART HA analog input module
16 analog inputs
Measuring range 0 to 20 mA, 0 to 10 mA, 4 to 20 mA, 4 to 20 mA with HART
- AI 16xTC/8xRTD 2-/3-/4-wire HA analog input module
16 analog inputs for thermocouples;
alternatively 8 analog inputs for thermistors
- AQ 8xI HART HA analog output module
8 analog outputs
Power output in the output ranges 0 to 10 mA, 0 to 20 mA, 4 to 20 mA and 4 to 20 mA HART

Technical specifications

Article number	6DL1134-6JH00-0PH1	6DL1134-6TH00-0PH1
	ET 200SP HA, AI 16XTC/8XRTD 2-/3-/4-WIRE	ET 200SP HA, AI 16XI 2-WIRE HART
General information		
Product type designation	AI 16 x TC/8 x RTD 2/3/4-wire HA	AI 16 x I 2-wire mA HART
Product function		
• I&M data	Yes; I&M0 to I&M3	Yes; I&M0 to I&M3
Engineering with		
• STEP 7 TIA Portal configurable/ integrated as of version	V16	
• PCS 7 configurable/integrated as of version	V9.0	V9.0
Supply voltage		
Rated value (DC)	24 V	24 V
Reverse polarity protection	Yes	Yes
Analog inputs		
Number of analog inputs		16
• For voltage measurement	16	
• For resistance/resistance thermometer measurement	8	
• For thermocouple measurement	16	
permissible input voltage for voltage input (destruction limit), max.	5 V	
permissible input current for current input (destruction limit), max.		30 mA
Constant measurement current for resistance-type transmitter, typ.	2 mA	
Technical unit for temperature measurement adjustable	Yes; °C/°F/K	
Input ranges (rated values), voltages		
• -1 V to +1 V	Yes; 16 bit incl. sign	
• -250 mV to +250 mV	Yes; 16 bit incl. sign	
• -50 mV to +50 mV	Yes; 16 bit incl. sign	
• -80 mV to +80 mV	Yes; 16 bit incl. sign	
Input ranges (rated values), currents		
• 0 to 20 mA		Yes; 16 bit incl. sign
• 4 mA to 20 mA		Yes; 16 bit incl. sign

I/O systemsSIMATIC ET 200 systems for the control cabinet
SIMATIC ET 200SP HA**Analog I/O modules****Technical specifications**

Article number	6DL1134-6JH00-0PH1 ET 200SP HA, AI 16XTC/8XRTD 2-/3-/4-WIRE	6DL1134-6TH00-0PH1 ET 200SP HA, AI 16XI 2-WIRE HART
Input ranges (rated values), thermocouples		
• Type B	Yes; 16 bit incl. sign	
• Type C	Yes; 16 bit incl. sign	
• Type E	Yes; 16 bit incl. sign	
• Type J	Yes; 16 bit incl. sign	
• Type K	Yes; 16 bit incl. sign	
• Type L	Yes; 16 bit incl. sign	
• Type N	Yes; 16 bit incl. sign	
• Type R	Yes; 16 bit incl. sign	
• Type S	Yes; 16 bit incl. sign	
• Type T	Yes; 16 bit incl. sign	
• Type U	Yes; 16 bit incl. sign	
• Type TXK/TXK(L) to GOST	Yes; 16 bit incl. sign	
Input ranges (rated values), resistance thermometer		
• Cu 10	Yes; 16 bit incl. sign	
• Ni 100	Yes; 16 bit incl. sign	
• Ni 1000	Yes; 16 bit incl. sign	
• LG-Ni 1000	Yes; 16 bit incl. sign	
• Ni 120	Yes; 16 bit incl. sign	
• Ni 200	Yes; 16 bit incl. sign	
• Ni 500	Yes; 16 bit incl. sign	
• Pt 100	Yes; 16 bit incl. sign	
• Pt 1000	Yes; 16 bit incl. sign	
• Pt 200	Yes; 16 bit incl. sign	
• Pt 500	Yes; 16 bit incl. sign	
Input ranges (rated values), resistors		
• 0 to 150 ohms	Yes; 15 bit	
• 0 to 300 ohms	Yes; 15 bit	
• 0 to 600 ohms	Yes; 15 bit	
• 0 to 3000 ohms	Yes; 15 bit	
• 0 to 6000 ohms	Yes; 15 bit	
• PTC	Yes; 15 bit	
Thermocouple (TC)		
Temperature compensation		
- parameterizable	Yes	
Cable length		
• shielded, max.	200 m; Measurement ranges for thermocouples / voltages: shielded cable length max. 600 m, loop resistance max 8 kOhm; measuring ranges RTD: shielded cable length max. 600 m, cable resistance (single) max. 75 ohms	800 m; with unshielded cables up to 800 m, remember that (external) EMC loads can cause incorrect measured values
Analog value generation for the inputs		
Measurement principle	integrating (Sigma-Delta)	integrating (Sigma-Delta)
Integration and conversion time/resolution per channel		
• Resolution with overrange (bit including sign), max.	16 bit	16 bit; 15 bit at 0 ... 10 mA and 60 Hz interference suppression
• Integration time, parameterizable	Yes; Channel-by-channel, results from the selected interference frequency suppression	Yes; channel by channel
• Interference voltage suppression for interference frequency f1 in Hz	16.6 / 50 / 60 Hz, channel-by-channel	
• Conversion time (per channel)	60 ms; 180 / 50 ms, results from the selected interference frequency suppression	
Smoothing of measured values		
• parameterizable	Yes; none, weak, medium, strong, channel-by-channel	Yes; none, weak, medium, strong, channel-by-channel

Technical specifications

Article number	6DL1134-6JH00-0PH1 ET 200SP HA, AI 16XTC/8XRTD 2-/3-/4-WIRE	6DL1134-6TH00-0PH1 ET 200SP HA, AI 16XI 2-WIRE HART
Encoder		
Connection of signal encoders		
• for current measurement as 2-wire transducer		Yes
Errors/accuracies		
Basic error limit (operational limit at 25 °C)		
• Voltage, relative to input range, (+/-)	0.05 %	
• Current, relative to input range, (+/-)		0.1 %
• Resistance, relative to input range, (+/-)	0.05 %	
Interference voltage suppression for $f = n \times (f_1 \pm 1 \%)$, $f_1 =$ interference frequency		
• Series mode interference (peak value of interference < rated value of input range), min.	70 dB	
• Common mode voltage, max.	60 V	
• Common mode interference, min.	90 dB	
Interrupts/diagnostics/status information		
Diagnostics function	Yes	Yes
Alarms		
• Diagnostic alarm	Yes	Yes
• Limit value alarm	Yes; two upper and two lower limit values in each case	Yes; two upper and two lower limit values in each case
Diagnostic messages		
• Monitoring the supply voltage	Yes	Yes
• Wire-break	Yes; channel by channel	Yes; channel by channel
• Short-circuit		Yes; Channel-by-channel, short-circuit of the encoder supply to ground or of an input to the encoder supply
• Overflow/underflow	Yes; channel by channel	Yes; channel by channel
Diagnostics indication LED		
• MAINT LED	Yes; Yellow LED	Yes; Yellow LED
• Monitoring of the supply voltage (PWR-LED)	Yes; green PWR LED	Yes; green PWR LED
• Channel status display	Yes; green LED	Yes; green LED
• for channel diagnostics	Yes; red LED	Yes; red LED
• for module diagnostics	Yes; green/red DIAG LED	Yes; green/red DIAG LED
Potential separation		
Potential separation channels		
• between the channels and backplane bus	Yes	Yes
Ambient conditions		
Ambient temperature during operation		
• horizontal installation, min.	-40 °C	-40 °C
• horizontal installation, max.	70 °C	70 °C; Observe derating
• vertical installation, min.	-40 °C	-40 °C
• vertical installation, max.	60 °C	60 °C; Observe derating
Dimensions		
Width	22.5 mm	22.5 mm
Height	115 mm	115 mm
Depth	138 mm	138 mm
Weights		
Weight, approx.	150 g	148 g

I/O systems

SIMATIC ET 200 systems for the control cabinet
SIMATIC ET 200SP HA

Analog I/O modules**Technical specifications**

Article number	6DL1135-6TF00-0PH1 ET 200SP HA, AQ 8XI HART
General information	
Product type designation	AQ 8 x I HART HA
Product function	
• I&M data	Yes; I&M0 to I&M3
Engineering with	
• PCS 7 configurable/integrated as of version	V9.0
Supply voltage	
Rated value (DC)	24 V
Reverse polarity protection	Yes
Analog outputs	
Number of analog outputs	8
Output ranges, current	
• 0 to 10 mA	Yes; 14 bit
• 0 to 20 mA	Yes; 15 bit
• -20 mA to +20 mA	No
• 4 mA to 20 mA	Yes; 16 bit incl. sign
Connection of actuators	
• for current output two-wire connection	Yes
Load impedance (in rated range of output)	
• with current outputs, max.	750 Ω
• with current outputs, inductive load, max.	10 mH
Cable length	
• shielded, max.	1 000 m; with unshielded cables up to 800 m, remember that (external) EMC loads can cause incorrect measured values
Settling time	
• for resistive load	1.2 ms; 750 ohm
• for inductive load	1.2 ms
Errors/accuracies	
Basic error limit (operational limit at 25 °C)	
• Current, relative to output range, (+/-)	0.1 %

Article number	6DL1135-6TF00-0PH1 ET 200SP HA, AQ 8XI HART
Interrupts/diagnostics/status information	
Diagnostics function	Yes
Substitute values connectable	Yes
Alarms	
• Diagnostic alarm	Yes
Diagnostic messages	
• Monitoring the supply voltage	Yes
• Wire-break	Yes; channel by channel
• Short-circuit	Yes; channel by channel
• Overflow/underflow	Yes; channel by channel
Diagnostics indication LED	
• MAINT LED	Yes; Yellow LED
• Monitoring of the supply voltage (PWR-LED)	Yes; green PWR LED
• Channel status display	Yes; green LED
• for channel diagnostics	Yes; red LED
• for module diagnostics	Yes; green/red DIAG LED
Potential separation	
Potential separation channels	
• between the channels and backplane bus	Yes
Ambient conditions	
Ambient temperature during operation	
• horizontal installation, min.	-40 °C
• horizontal installation, max.	70 °C
• vertical installation, min.	-40 °C
• vertical installation, max.	60 °C
Dimensions	
Width	22.5 mm
Height	115 mm
Depth	138 mm
Weights	
Weight, approx.	160 g

Ordering data	Article No.	Accessories	Article No.
AI 16xI 2-wire HART HA analog input module 16 analog inputs Measuring range 0 to 20 mA, 0 to 10 mA, 4 to 20 mA, 4 to 20 mA with HART Color code CC01, for terminal block type H1 and M1, channel diagnostics, 16-bit	6DL1134-6TH00-0PH1	Labeling strips For labeling the I/O modules <ul style="list-style-type: none"> Roll, light gray (with a total of 500 labeling strips), 1 unit A4 sheets, light gray (with a total of 1 000 labeling strips), 10 units 	6DL1193-6LR00-0AA0 6DL1193-6LA00-0AA0
AI 16xTC/8xRTD 2-/3-/4-wire HA analog input module 16 analog inputs for thermocouples; alternatively 8 analog inputs for thermistors Color code CC00, for terminal block type H1 and M1, channel diagnostics, 16-bit	6DL1134-6JH00-0PH1	Color-coding labels For push-in terminals <ul style="list-style-type: none"> Color code CC00, 10 units gray (terminals 1 to 32) Color code CC01, 10 units gray (terminals 1 to 16), red (terminals 17 to 32) 	6DL1193-6CP00-2HH1 6DL1193-6CP01-2HH1
AQ 8xI HART HA analog output module 8 analog outputs Power output in the output ranges 0 to 10 mA, 0 to 20 mA, 4 to 20 mA and 4 to 20 mA HART Color code CC00, for terminal block type H1 and M1, channel diagnostics, 16-bit	6DL1135-6TF00-0PH1	Reference identification labels 10 sheets with 16 strips each	6ES7193-6LF30-0AW0
		PM cover Slot cover for I/O modules, to protect vacant I/O slots Width 22.5 mm, 5 units	6DL1133-6CV22-0AM0

I/O systems

SIMATIC ET 200 systems for the control cabinet
SIMATIC ET 200SP HA

Analog/digital module

Overview



The I/O module AI-DI 16/DQ16x24VDC HART HA is available in the following versions:

- DI 16/DQ16x24VDC HA in digital-only mode
- AI-DI 16/DQ 16x24VDC HART HA as digital/analog module in mixed mode

Time stamping is available with configuration in mixed mode. High-precision time stamping (SoE: Sequence of Events) with a precision of 1 ms is available with configuration in digital-only mode.

In mixed mode, the 16 inputs can also be set channel by channel as either digital inputs or analog inputs with or without HART. HART is only available in mixed mode and with configuration in a measuring range of 4 to 20 mA.

Technical specifications

Article number	6DL1133-6EW00-0PH1 ET 200SP HA, AI-DI16/DQ16x24VDC HART
General information	
Product type designation	AI-DI 16/DQ 16x24VDC HART HA
Engineering with	
• PCS 7 configurable/integrated as of version	V9.0
Operating mode	
• DI	Yes
• Counter	Yes
• DQ	Yes
• DQ with energy-saving function	No
• PWM	No
• Oversampling	No
• MSI	No
• MSO	No
Supply voltage	
Rated value (DC)	24 V
Reverse polarity protection	Yes
Encoder supply	
Number of outputs	16
Short-circuit protection	Yes; per channel, electronic
Digital inputs	
Number of digital inputs	16
Digital inputs, parameterizable	Yes
Source/sink input	Yes; P-reading
Input characteristic curve in accordance with IEC 61131, type 1	Yes
Input characteristic curve in accordance with IEC 61131, type 2	No
Input characteristic curve in accordance with IEC 61131, type 3	Yes
Pulse extension	Yes; off, 50 ms, 100 ms, 200 ms, 500 ms, 1 s, 2 s
Time stamping	Yes; Resolution 10 ms
Time stamp (with precision of 1 ms)	Yes; Resolution 1ms

Article number	6DL1133-6EW00-0PH1 ET 200SP HA, AI-DI16/DQ16x24VDC HART
Digital input functions, parameterizable	
• Gate start/stop	Yes; Partner channel of n+8 counter
• Freely usable digital input	Yes; Parameterizable input filter
• Counter	Yes; Incl. frequency measurement
- Number, max.	8; Counter channel n=0 ... 7
- Counting frequency, max.	5 kHz
- Counting width	32 bit; Without sign
- Counting direction up/down	Yes; Up
Input voltage	
• Type of input voltage	DC
• Rated value (DC)	24 V
• for signal "0"	-30 to +5V
• for signal "1"	+11 to +30V
Input current	
• for signal "1", typ.	2.5 mA
Input delay (for rated value of input voltage) for standard inputs	
- parameterizable	Yes; 0.05 / 0.1 / 0.4 / 0.8 / 1.6 / 3.2 / 12.8 / 20 ms (in each case + delay of 30 to 500 µs, depending on line length)
Cable length	
• shielded, max.	1 000 m
• unshielded, max.	600 m
Digital outputs	
Number of digital outputs	16
Current-sinking	No
Current-sourcing	Yes
Digital outputs, parameterizable	Yes
Short-circuit protection	Yes; Response threshold 0.7 A to 1.3 A
Open-circuit detection	Yes
Overload protection	Yes
Limitation of inductive shutdown voltage to	L+ -(37 to 41V)
Controlling a digital input	Yes

Technical specifications

Article number	6DL1133-6EW00-0PH1 ET 200SP HA, AI-DI16/DQ16X24VDC HART
Switching capacity of the outputs	
• with resistive load, max.	0.5 A
• on lamp load, max.	5 W
Load resistance range	
• lower limit	48 Ω
• upper limit	12 kΩ
Output current	
• for signal "1" rated value	0.5 A
• for signal "0" residual current, max.	0.7 mA
Output delay with resistive load	
• "0" to "1", typ.	50 μs
• "1" to "0", typ.	100 μs
Parallel switching of two outputs	
• for uprating	No
• for redundant control of a load	Yes
Switching frequency	
• with resistive load, max.	100 Hz
• with inductive load, max.	2 Hz
• on lamp load, max.	10 Hz
Total current of the outputs	
• Current per channel, max.	0.5 A
• Current per module, max.	2 A
Cable length	
• shielded, max.	1 000 m
• unshielded, max.	600 m
Analog inputs	
Number of analog inputs	16
permissible input current for current input (destruction limit), max.	30 mA
Input ranges	
• Current	Yes; 0 ... 10 mA, 0 ... 20 mA, 4 ... 20 mA, 4 ... 20 mA HART
Input ranges (rated values), currents	
• 0 to 10 mA	Yes
• 0 to 20 mA	Yes; 16 bit incl. sign
• 4 mA to 20 mA	Yes; 16 bit incl. sign
Analog value generation for the inputs	
Integration and conversion time/resolution per channel	
• Resolution with overrange (bit including sign), max.	16 bit; Resolution with overrange (bit including sign), max. 16 bits, exception: 15 bits at 60 Hz interference suppression and 0 to 10 mA
• Integration time, parameterizable	Yes; channel by channel
Smoothing of measured values	
• parameterizable	Yes; none, weak, medium, strong, channel-by-channel

Article number	6DL1133-6EW00-0PH1 ET 200SP HA, AI-DI16/DQ16X24VDC HART
Encoder	
Connection of signal encoders	
• for current measurement as 2-wire transducer	Yes
Connectable encoders	
• 2-wire sensor	Yes
- permissible quiescent current (2-wire sensor), max.	1.5 mA
Errors/accuracies	
Basic error limit (operational limit at 25 °C)	
• Current, relative to input range, (+/-) 0.1 %	
Interrupts/diagnostics/status information	
Diagnostics function	Yes
Substitute values connectable	Yes
Alarms	
• Diagnostic alarm	Yes
• Maintenance interrupt	Yes
• Limit value alarm	Yes; two upper and two lower limit values in each case
• Hardware interrupt	Yes; Parameterizable, channels 0 to 15, rising/falling edge
Diagnostic messages	
• Monitoring the supply voltage	Yes
• Wire-break	Yes; channel by channel
• Short-circuit to M	Yes; Encoder supply to M, channel by channel
• Group error	Yes
• Overflow/underflow	Yes; channel by channel
Diagnostics indication LED	
• MAINT LED	Yes; Yellow LED
• Monitoring of the supply voltage (PWR-LED)	Yes; green PWR LED
• Channel status display	No
• for channel diagnostics	No
• for module diagnostics	Yes; green/red DIAG LED
Integrated Functions	
Frequency measurement	Yes
Number of frequency meters	8
Counting functions	
• Continuous counting	Yes
• Counter response parameterizable	Yes
• Hardware gate via digital input	Yes; Via partner channel (digital input n+8)
• Software gate	Yes
Measuring functions	
• Dynamic measurement period adjustment	Yes
Measuring range	
- Frequency measurement, min.	0.1 Hz
- Frequency measurement, max.	5 kHz
Accuracy	
- Frequency measurement	100 ppm; depending on measuring interval and signal evaluation

I/O systemsSIMATIC ET 200 systems for the control cabinet
SIMATIC ET 200SP HA**Analog/digital module****Technical specifications**

Article number	6DL1133-6EW00-0PH1 ET 200SP HA, AI-DI16/DQ16X24VDC HART
Potential separation	
Potential separation channels	Yes
• between the channels and backplane bus	
Ambient conditions	
Ambient temperature during operation	
• horizontal installation, min.	-40 °C
• horizontal installation, max.	70 °C; Observe derating
• vertical installation, min.	-40 °C
• vertical installation, max.	60 °C; Observe derating
Dimensions	
Width	22.5 mm
Height	115 mm
Depth	138 mm
Weights	
Weight, approx.	150 g

Ordering data**Article No.**

AI-DI 16/DQ16x24VDC HART HA input/output module 16 channels, each with digital output and digital/analog input Color code CC01, for terminal block type H1 and M1	6DL1133-6EW00-0PH1
Accessories	
Labeling strips For labeling the I/O modules	
• Roll, light gray (with a total of 500 labeling strips), 1 unit	6DL1193-6LR00-0AA0
• A4 sheets, light gray (with a total of 1 000 labeling strips), 10 units	6DL1193-6LA00-0AA0
Color-coding labels For push-in terminals	
• Color code CC01, 10 units gray (terminals 1 to 16), red (terminals 17 to 32)	6DL1193-6CP01-2HH1
Equipment labeling plates 10 sheets with 16 plates each	6ES7193-6LF30-0AW0
Slot cover for I/O modules 22.5 mm wide	6DL1133-6CV22-0AM0

Overview**Mounting rails**

The mounting rail is required for fitting an ET 200SP HA station in the control cabinet. The IM carrier modules for interface modules, the carrier modules for the I/O modules and the server module are attached to the mounting rail.

The mounting rails are available in lengths of 482 mm (for installation in a 19-inch rack) and 1 500 mm (for maximum configuration and vertical installation in a cabinet).



IM single carrier module



IM redundant carrier module

IM carrier modules for interface modules

Two versions of the IM carrier modules for interface modules are available:

- IM single carrier module for 1 interface module, for single connection to PROFINET
- IM redundant carrier module for 2 interface modules, for redundant connection to PROFINET

The IM carrier modules connect the interface module to the backplane bus. They enable data exchange with the I/O modules.



Carrier module for I/O modules, 8-slot



Carrier module for I/O modules, 2-slot

Carrier modules for I/O modules

The slots for the I/O modules are created by the connection of these carrier modules to the terminal blocks.

Carrier modules for I/O modules are available in the following versions:

- Carrier module, 2-slot, with 2 slots for I/O modules
- Carrier module, 8-slot, with 8 slots for I/O modules

I/O systems

SIMATIC ET 200 systems for the control cabinet
SIMATIC ET 200SP HA

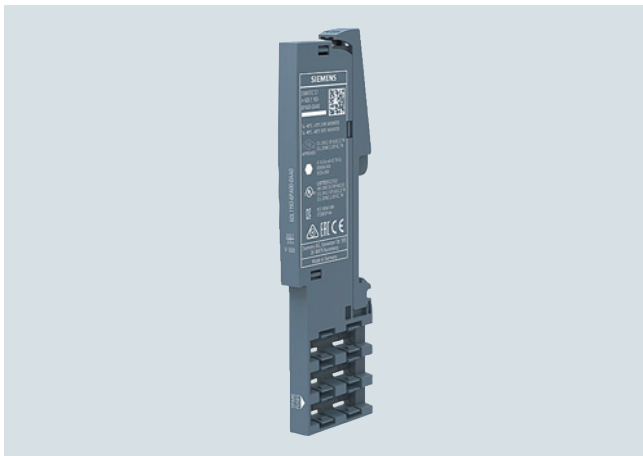
Carrier modules**Overview**

ET 200SP HA, server module

Server module

Server module and power bus cover complete the design of the ET 200SP HA. A server module and a power bus cover are supplied with each IM carrier module for the interface module.

Technical specifications

Article number	6DL1193-6BH00-0SM0 CARRIER MODULE IM SINGLE	6DL1193-6BH00-0RM0 CARRIER MODULE IM REDUNDANT
General information		
Product type designation	Carrier module IM single	Carrier module IM redundant
Product function		
• I&M data	Yes; Asset data	Yes; Asset data
Ambient conditions		
Ambient temperature during operation		
• horizontal installation, min.	-40 °C	-40 °C
• horizontal installation, max.	70 °C	70 °C
• vertical installation, min.	-40 °C	-40 °C
• vertical installation, max.	60 °C	60 °C
Dimensions		
Width	100 mm	100 mm
Height	204 mm	204 mm
Depth	52 mm	52 mm
Weights		
Weight, approx.	250 g	224 g
Article number	6DL1193-6GA00-0NN0 CARRIER MODULE TWOFOLD	6DL1193-6GC00-0NN0 CARRIER MODULE EIGHTFOLD
General information		
Product function		
• I&M data	Yes; Asset data	Yes; Asset data
Ambient conditions		
Ambient temperature during operation		
• horizontal installation, min.	-40 °C	-40 °C
• horizontal installation, max.	70 °C	70 °C
• vertical installation, min.	-40 °C	-40 °C
• vertical installation, max.	60 °C	60 °C
Dimensions		
Width	52.5 mm; 45 mm when installed	187.5 mm; 180 mm when installed
Height	203 mm	203 mm
Depth	79 mm	79 mm
Weights		
Weight, approx.	111 g	450 g

Ordering data	Article No.	Carrier modules for I/O modules	Article No.
Mounting rails for ET 200SP HA		Carrier module, 2-slot	
482 mm (ca. 19 inch) mounting rail Including grounding screw and integrated top hat rail for fitting small components such as clamps, fuses and relays	6DL1193-6MC00-0AA0	Rack for 2 SIMATIC ET 200SP HA I/O modules	6DL1193-6GA00-0NN0
1500 mm (ca. 59 inch) mounting rail Including grounding screw and integrated top hat rail for fitting small components such as clamps, fuses and relays	6DL1193-6MD00-0AA0	Carrier module, 8-slot Rack for 8 SIMATIC ET 200SP HA I/O modules	6DL1193-6GC00-0NN0
Grounding screw For connecting PE to the mounting rail; essential for 1 500 mm mounting rail 20 units per packing unit	6ES7590-5AA00-0AA0	Spare parts	
IM carrier modules for interface modules Note: A server module and a power bus cover are supplied with each IM carrier module for the interface module.		Server module (spare part) for ET 200SP HA	6DL1193-6PA00-0AA0
IM single carrier module Rack for 1 SIMATIC ET 200SP HA interface module for single connection to PROFINET	6DL1193-6BH00-0SM0		
IM redundant carrier module Rack for 2 SIMATIC ET 200SP HA interface modules for redundant connection to PROFINET	6DL1193-6BH00-0RM0		

I/O systems

SIMATIC ET 200 systems for the control cabinet
SIMATIC ET 200SP HA









Terminal blocks

Overview

The slots for the I/O modules are created by connecting carrier modules and terminal blocks. The terminal blocks contain the

process terminals for connecting sensors, actuators and other devices.

Overview of terminal blocks

24 V standard TB		24 V I/O redundancy TB		24 V load distribution TB		24 V M distributor TB		Insulated TB	
									
H1 light	H1 dark	M1 light	M1 dark	P0 light	P0 dark	N0 light	N0 dark	K0 light	K0 dark

Select the terminal block for the slot of an I/O module based on the following dependencies:

- Definition of I/O modules associated with a potential group

- Requirement for design with redundant I/O modules (redundant partner in adjacent slot)
- Requirement for design with potential distributors (e.g. when using 32-channel I/O modules)

The following table illustrates the terminal block / I/O module assignment (x = standard):

Terminal block / I/O module	24 V standard TB (H1)	24 V I/O redundancy TB (M1)	24 V load distribution TB (P0)	24 V M distributor TB (N0)	Insulated TB (K0)
DI 16x24VDC	x	Optional		Optional ¹⁾	
DI 32x24VDC	Optional		x		
DI 16xNAMUR	x	Optional		Optional ¹⁾	
DI 8x125VDC					x
DI 8x230VAC					x
DQ 16x24V/0,5A	x	Optional		Optional ¹⁾	
DQ 32x24V/0.5A	Optional			x	
RQ 4x230/5A CO					x
DI-AI 16x / DQ16x	x	Optional		Optional ¹⁾	
AI 16xI HART	x	Optional		Optional ¹⁾	
AI 16xTC 8xRTD	x	Optional			
AQ 8xI HART	x	Optional		Optional ¹⁾	

¹⁾ Offers additional ground points for field connection

Potential groups/color type of the terminal blocks

To help you distinguish between potential groups on ET 200SP HA stations the terminal blocks come in both a light and a dark version:

- Each light-colored terminal block that is fitted in the station starts a new potential group. The first terminal block fitted (on the first carrier module immediately to the right of the interface module) is therefore light-colored.
- Each dark terminal block forms a contact with the supply voltage of the terminal block to its left, thus extending the potential group.

Note the maximum permissible load current depending on the number of I/O modules:

Number of terminal blocks	Permissible load current in amperes
4	10 A
5	8 A
6	7 A
7	6 A
8	5 A
10	4 A
15	3 A
20	2 A

Technical specifications

Article number	6DL1193-6TP00-0DH1 TERMINAL BLOCK, TYPE H1, LIGHT COLORED	6DL1193-6TP00-0BH1 TERMINAL BLOCK, TYPE H1, DARK-COLORED	6DL1193-6TP00-0DM1 TERMINAL BLOCK, TYPE M1, LIGHT COLORED	6DL1193-6TP00-0BM1 TERMINAL BLOCK, TYPE M1, DARK-COLORED	6DL1193-6TP00-0DPO Terminal Block, Type P0, light-colored	6DL1193-6TP00-0BPO Terminal Block, Type P0, dark-colored
General information						
Product type designation	Type H1	Type H1	Type M1	Type M1	Type P0	Type P0
Product function						
• I&M data	Yes; Asset data	Yes; Asset data	Yes; Asset data	Yes; Asset data	Yes	Yes
Input current						
Current consumption, max.					640 mA; With one 20 mA encoder supply per channel	640 mA; With one 20 mA encoder supply per channel
Ambient conditions						
Ambient temperature during operation						
• horizontal installation, min.	-40 °C	-40 °C	-40 °C	-40 °C	-40 °C	-40 °C
• horizontal installation, max.	70 °C	70 °C	70 °C	70 °C	70 °C	70 °C
• vertical installation, min.	-40 °C	-40 °C	-40 °C	-40 °C	-40 °C	-40 °C
• vertical installation, max.	60 °C	60 °C	60 °C	60 °C	60 °C	60 °C
Dimensions						
Width	22.5 mm	22.5 mm	45 mm	45 mm	45 mm	45 mm
Height	175 mm	175 mm	175 mm	175 mm	175 mm	175 mm
Depth	77 mm	77 mm	77 mm	77 mm	77 mm	77 mm
Weights						
Weight, approx.	80 g	80 g	155 g	155 g	155 g	155 g
Article number	6DL1193-6TP00-0DN0 Terminal Block, Type N0, light-colored	6DL1193-6TP00-0BN0 Terminal Block, Type N0, dark-colored	6DL1193-6TP00-0DK0 TERMINAL BLOCK, TYPE K0, LIGHT COLORED		6DL1193-6TP00-0BK0 TERMINAL BLOCK, TYPE K0, DARK-COLORED	
General information						
Product type designation	Type N0	Type N0	Type K0		Type K0	
Product function						
• I&M data	Yes	Yes	Yes; Asset data		Yes; Asset data	
Ambient conditions						
Ambient temperature during operation						
• horizontal installation, min.	-40 °C	-40 °C	-40 °C		-40 °C	
• horizontal installation, max.	70 °C	70 °C	70 °C		70 °C	
• vertical installation, min.	-40 °C	-40 °C	-40 °C		-40 °C	
• vertical installation, max.	60 °C	60 °C	60 °C		60 °C	
Dimensions						
Width	45 mm	45 mm	22.5 mm		22.5 mm	
Height	175 mm	175 mm	175 mm		175 mm	
Depth	77 mm	77 mm	77 mm		77 mm	
Weights						
Weight, approx.	155 g	155 g	78 g		78 g	

I/O systems

SIMATIC ET 200 systems for the control cabinet
SIMATIC ET 200SP HA

Terminal blocks**Ordering data****Article No.****Terminal blocks 24 V DC****Terminal block type H1 light**

For starting a new potential group, with 32 push-in terminals, width 22.5 mm, with temperature compensation

6DL1193-6TP00-0DH1**Terminal block type M1 light**

For starting a new potential group, with 32 push-in terminals, width 45 mm, for redundant configurations, with temperature compensation

6DL1193-6TP00-0DM1**Terminal block type P0 light**

For starting a new potential group, with 32 push-in terminals, additional 32 push-in terminals with encoder supply, width 45 mm, specially for use with DI 32x24 V DC (6DL1131-6BL00-0PH1)

6DL1193-6TP00-0DP0**Terminal block type N0 light**

For starting a new potential group, with 32 push-in terminals, additional 32 push-in terminals for ground connection, width 45 mm, for use with DQ 32x 24 V DC (6DL1132-6BL00-0PH1) and other modules

6DL1193-6TP00-0DN0**Terminal block type H1 dark**

For forwarding a potential group, with 32 push-in terminals, width 22.5 mm, with temperature compensation

6DL1193-6TP00-0BH1**Terminal block type M1 dark**

For forwarding a potential group, with 32 push-in terminals, width 45 mm, for redundant configurations, with temperature compensation

6DL1193-6TP00-0BM1**Terminal block type P0 dark**

For forwarding a potential group, with 32 push-in terminals, additional 32 push-in terminals with encoder supply, width 45 mm, specially for use with DI 32x24 V DC (6DL1131-6BL00-0PH1)

6DL1193-6TP00-0BP0**Terminal block type N0 dark**

For starting a new potential group, with 32 push-in terminals, additional 32 push-in terminals for ground connection, width 45 mm, for use with DQ 32x 24 V DC (6DL1132-6BL00-0PH1) and other modules

6DL1193-6TP00-0BN0**Article No.****Terminal blocks insulated (24 V DC / 125 V DC / 230 V AC)****Terminal block type K0 light**

For starting a new potential group, with 16 push-in terminals, width 22.5 mm

6DL1193-6TP00-0DK0**Terminal block type K0 dark**

For forwarding a potential group, with 16 push-in terminals, width 22.5 mm

6DL1193-6TP00-0BK0**Accessories****Shield connection for terminal block**

5 shield supports and 5 shield terminals, for direct connection

6ES7193-6SC00-1AM0

Overview



BusAdapter BA 2xRJ45, 2xFC and 2xLC

BusAdapter

A BusAdapter as a separate component allows a free choice of connection technology:

- BA 2xRJ45: 2 electrical connections for bus cable with standard RJ45 connector
- BA 2xFC: 2 electrical connections for direct connection of FastConnect bus cable
- BA 2xLC: 2 optical ports for fiber-optic cables

Technical specifications

Article number	6DL1193-6AR00-0AA0 ET 200SP HA, BUSADAPTER BA 2XRJ45	6DL1193-6AF00-0AA0 ET 200SP HA, BUSADAPTER BA 2XFC	6DL1193-6AG00-0AA0 ET 200SP HA, BUSADAPTER BA 2XLC
General information			
Product type designation	BA 2x RJ45	BA 2xFC	BA 2xLC
Interfaces			
Number of PROFINET interfaces	1; 2 ports (switch) RJ45	1; 2 ports (switch) FC	1; 2 ports (switch) LC Multimode Glass Fibre
Supports protocol for PROFINET IO			
• Number of RJ45 ports	2		
• Number of FC (FastConnect) connections		2	
• Number of LC ports			2
Cable length			
- Cu conductors	100 m	100 m	
- Multimode graded-index fiber 50/125 µm			3 km
- Multimode graded-index fiber 62.5/125 µm			3 km
Ambient conditions			
Ambient temperature during operation			
• min.	-40 °C	-40 °C	-40 °C
• max.	70 °C	70 °C	65 °C; redundant design (2x 6DL1155-6AU00-0PM0): max. 60 °C horizontal, max. 50 °C vertical. When using different I/O devices, the derating specified there must be observed
Dimensions			
Width	20 mm	20 mm	20 mm
Height	69.5 mm	69.5 mm	75 mm; Without protective caps (approx. 8 mm)
Depth	59 mm	59 mm	59 mm
Weights			
Weight, approx.	46 g	53 g	60 g

I/O systems

SIMATIC ET 200 systems for the control cabinet
SIMATIC ET 200SP HA

BusAdapter

Ordering data	Article No.
BusAdapter	
BusAdapter 2xRJ45 2 × RJ45 sockets for PROFINET (standard Ethernet socket)	6DL1193-6AR00-0AA0
BusAdapter 2xFC 2 × FastConnect (FC) connections for PROFINET	6DL1193-6AF00-0AA0
BusAdapter 2xLC 2 × glass fiber-optic connections for PROFINET	6DL1193-6AG00-0AA0
BusAdapter BA LC/RJ45 2 × glass fiber-optic connections	6DL1193-6AG20-0AA0
BusAdapter BA LC/FC 2 × glass fiber-optic connections	6DL1193-6AG40-0AA0
BusAdapter BA 2xRJ45 (VD) 2 × electrical connections for Ethernet communication via 2-, 4- or 8-wire copper cables and distances up to 500 m	6GK5991-2VA00-8AA2

Overview



- Interface module for linking the ET 200MP to PROFINET
- Handles data exchange with the PROFINET I/O controller in the PLC
- Integrated 2-port switch for line topology
- Max. 30 I/O modules
- Shortest bus cycle 250 μ s
- Linking to the isochronous task of the CPU
- Prioritized fast startup (FSU) with 500 ms (max. 12 I/O modules)
- Media Redundancy Protocol (MRP)
- Shared device on up to two I/O controllers (when configuring using GSD file; depends on the respective configuration tool)
- Omission of SIMATIC Memory Card (SMC); IM replacement without PG using LLDP

Note:

SIPLUS extreme products are based on SIMATIC standard products. The contents listed here were taken from the respective standard products. SIPLUS extreme-specific information was added.

Technical specifications

Article number	6AG1155-5AA01-7AB0	6AG1155-5AA00-2AC0
Based on	6ES7155-5AA01-0AB0	6ES7155-5AA00-0AC0
	SIPLUS ET 200MP IM 155-5 PN ST	SIPLUS ET 200MP IM155-5 PN HF
Ambient conditions		
Ambient temperature during operation		
• horizontal installation, min.	-40 °C; = Tmin (incl. condensation/frost)	-40 °C; = Tmin (incl. condensation/frost); start-up @ -25 °C
• horizontal installation, max.	70 °C; = Tmax; ab > +60 °C no module permissible left of the IM	60 °C; = Tmax
• vertical installation, min.	-40 °C; = Tmin	
• vertical installation, max.	40 °C	
Altitude during operation relating to sea level		
• Installation altitude above sea level, max.	5 000 m	5 000 m
• Ambient air temperature-barometric pressure-altitude	Tmin ... Tmax at 1 080 hPa ... 795 hPa (-1 000 m ... +2 000 m) // Tmin ... (Tmax - 10 K) at 795 hPa ... 658 hPa (+2 000 m ... +3 500 m) // Tmin ... (Tmax - 20 K) at 658 hPa ... 540 hPa (+3 500 m ... +5 000 m); from 2 000 m max. 132 V AC	Tmin ... Tmax at 1 140 hPa ... 795 hPa (-1 000 m ... +2 000 m) // Tmin ... (Tmax - 10 K) at 795 hPa ... 658 hPa (+2 000 m ... +3 500 m) // Tmin ... (Tmax - 20 K) at 658 hPa ... 540 hPa (+3 500 m ... +5 000 m)
Relative humidity		
• With condensation, tested in accordance with IEC 60068-2-38, max.	100 %; RH incl. condensation / frost (no commissioning in bedewed state), horizontal installation	100 %; RH incl. condensation/frost (no commissioning under condensation conditions)
Resistance		
Coolants and lubricants		
- Resistant to commercially available coolants and lubricants	Yes; Incl. diesel and oil droplets in the air	Yes; Incl. diesel and oil droplets in the air
Use in stationary industrial systems		
- to biologically active substances according to EN 60721-3-3	Yes; Class 3B2 mold, fungus and dry rot spores (with the exception of fauna); Class 3B3 on request	Yes; Class 3B2 mold, fungus and dry rot spores (with the exception of fauna); Class 3B3 on request
- to chemically active substances according to EN 60721-3-3	Yes; Class 3C4 (RH < 75 %) incl. salt spray acc. to EN 60068-2-52 (severity degree 3); *	Yes; Class 3C4 (RH < 75 %) incl. salt spray acc. to EN 60068-2-52 (severity degree 3); *
- to mechanically active substances according to EN 60721-3-3	Yes; Class 3S4 incl. sand, dust, *	Yes; Class 3S4 incl. sand, dust, *

I/O systemsSIMATIC ET 200 systems for the control cabinet
SIMATIC ET 200MP**Interface modules > SIPLUS IM 155-5 PN****Technical specifications**

Article number	6AG1155-5AA01-7AB0	6AG1155-5AA00-2AC0
Based on	6ES7155-5AA01-0AB0 SIPLUS ET 200MP IM 155-5 PN ST	6ES7155-5AA00-0AC0 SIPLUS ET 200MP IM155-5 PN HF
Use on ships/at sea		
- to biologically active substances according to EN 60721-3-6	Yes; Class 6B2 mold and fungal spores (excluding fauna); Class 6B3 on request	Yes; Class 6B2 mold and fungal spores (excluding fauna); Class 6B3 on request
- to chemically active substances according to EN 60721-3-6	Yes; Class 6C3 (RH < 75 %) incl. salt spray acc. to EN 60068-2-52 (severity degree 3); *	Yes; Class 6C3 (RH < 75 %) incl. salt spray acc. to EN 60068-2-52 (severity degree 3); *
- to mechanically active substances according to EN 60721-3-6	Yes; Class 6S3 incl. sand, dust; *	Yes; Class 6S3 incl. sand, dust; *
Usage in industrial process technology		
- Against chemically active substances acc. to EN 60654-4	Yes; Class 3 (excluding trichlorethylene)	Yes; Class 3 (excluding trichlorethylene)
- Environmental conditions for process, measuring and control systems acc. to ANSI/ISA-71.04	Yes; Level GX group A/B (excluding trichlorethylene; harmful gas concentrations up to the limits of EN 60721-3-3 class 3C4 permissible); level LC3 (salt spray) and level LB3 (oil)	Yes; Level GX group A/B (excluding trichlorethylene; harmful gas concentrations up to the limits of EN 60721-3-3 class 3C4 permissible); level LC3 (salt spray) and level LB3 (oil)
Remark		
- Note regarding classification of environmental conditions acc. to EN 60721, EN 60654-4 and ANSI/ISA-71.04	* The supplied plug covers must remain in place over the unused interfaces during operation!	* The supplied plug covers must remain in place over the unused interfaces during operation!
Conformal coating		
• Coatings for printed circuit board assemblies acc. to EN 61086	Yes; Class 2 for high availability	Yes; Class 2 for high availability
• Protection against fouling acc. to EN 60664-3	Yes; Type 1 protection	Yes; Type 1 protection
• Military testing according to MIL-I-46058C, Amendment 7	Yes; Discoloration of coating possible during service life	Yes; Discoloration of coating possible during service life
• Qualification and Performance of Electrical Insulating Compound for Printed Board Assemblies according to IPC-CC-830A	Yes; Conformal coating, Class A	Yes; Conformal coating, Class A

Ordering data**Article No.****SIPLUS IM 155-5 PN interface module**

(Extended temperature range and exposure to media)

IP 20 degree of protection, module width 35 mm, installation on S7-1500 mounting rail

IM 155-5 PN ST, standard version

6AG1155-5AA01-7AB0

IM 155-5 PN HF, High Feature version with additional functions

6AG1155-5AA00-2AC0**Accessories**

See SIMATIC ET 200MP, IM 155-5 PN interface module, catalog ST 70 · 2019, page 9/216

Overview



- Interface module for linking the ET 200MP to PROFIBUS
- Handles data exchange with the PROFIBUS master in the PLC
- Max. 12 I/O modules
- Automatic detection of baud rate 9.6 kBd ... 12 MBd
- PROFIBUS addresses 1 ... 125; adjustable using DIP switches
- Identification and maintenance data IM0 ... IM3

Note:

SIPLUS extreme products are based on SIMATIC standard products. The contents listed here were taken from the respective standard products. SIPLUS extreme-specific information was added.

Technical specifications

Article number	6AG1155-5BA00-2AB0
Based on	6ES7155-5BA00-0AB0 SIPLUS ET 200MP IM155-5 DP ST
Ambient conditions	
Ambient temperature during operation	
• horizontal installation, min.	-40 °C; = Tmin (incl. condensation/frost); start-up @ -25 °C
• horizontal installation, max.	60 °C; = Tmax
Altitude during operation relating to sea level	
• Ambient air temperature-barometric pressure-altitude	Tmin ... Tmax at 1 080 hPa ... 795 hPa (-1 000 m ... +2 000 m) // Tmin ... (Tmax - 10 K) at 795 hPa ... 658 hPa (+2 000 m ... +3 500 m) // Tmin ... (Tmax - 20 K) at 658 hPa ... 540 hPa (+3 500 m ... +5 000 m)
Relative humidity	
• With condensation, tested in accordance with IEC 60068-2-38, max.	100 %; RH incl. condensation / frost (no commissioning in bedewed state), horizontal installation
Resistance	
Coolants and lubricants	
- Resistant to commercially available coolants and lubricants	Yes; Incl. diesel and oil droplets in the air

Article number	6AG1155-5BA00-2AB0
Based on	6ES7155-5BA00-0AB0 SIPLUS ET 200MP IM155-5 DP ST

Use in stationary industrial systems

- | | |
|---|--|
| - to biologically active substances according to EN 60721-3-3 | Yes; Class 3B2 mold, fungus and dry rot spores (with the exception of fauna); Class 3B3 on request |
| - to chemically active substances according to EN 60721-3-3 | Yes; Class 3C4 (RH < 75%) incl. salt spray according to EN 60068-2-52 (degree of severity 3). The supplied connector covers must remain on the unused interfaces during operation! |
| - to mechanically active substances according to EN 60721-3-3 | Yes; Class 3S4 incl. sand, dust. The supplied connector covers must remain on the unused interfaces during operation! |

Use on ships/at sea

- | | |
|---|--|
| - to biologically active substances according to EN 60721-3-6 | Yes; Class 6B2 mold and fungal spores (excluding fauna); Class 6B3 on request |
| - to chemically active substances according to EN 60721-3-6 | Yes; Class 6C3 (RH < 75 %) incl. salt spray acc. to EN 60068-2-52 (severity degree 3); * |
| - to mechanically active substances according to EN 60721-3-6 | Yes; Class 6S3 incl. sand, dust; * |

Usage in industrial process technology

- | | |
|--|---|
| - Against chemically active substances acc. to EN 60654-4 | Yes; Class 3 (excluding trichlorethylene) |
| - Environmental conditions for process, measuring and control systems acc. to ANSI/ISA-71.04 | Yes; Level GX group A/B (excluding trichlorethylene; harmful gas concentrations up to the limits of EN 60721-3-3 class 3C4 permissible); level LC3 (salt spray) and level LB3 (oil) |

Remark

- Note regarding classification of environmental conditions acc. to EN 60721, EN 60654-4 and ANSI/ISA-71.04

* The supplied plug covers must remain in place over the unused interfaces during operation!

Conformal coating

- | | |
|---|--|
| • Coatings for printed circuit board assemblies acc. to EN 61086 | Yes; Class 2 for high availability |
| • Protection against fouling acc. to EN 60664-3 | Yes; Type 1 protection |
| • Military testing according to MIL-I-46058C, Amendment 7 | Yes; Discoloration of coating possible during service life |
| • Qualification and Performance of Electrical Insulating Compound for Printed Board Assemblies according to IPC-CC-830A | Yes; Conformal coating, Class A |

Ordering data

SIPLUS IM 155-5 DP ST interface module
(Extended temperature range and exposure to media)
IP 20 degree of protection, module width 35 mm, installation on S7-1500 mounting rail

Article No.

6AG1155-5BA00-2AB0

Accessories

See SIMATIC ET 200MP, IM 155-5 DP interface module, catalog ST 70 · 2019, page 9/218

I/O systems

SIMATIC ET 200 systems for the control cabinet
SIMATIC ET 200MP

Active backplane bus

Overview

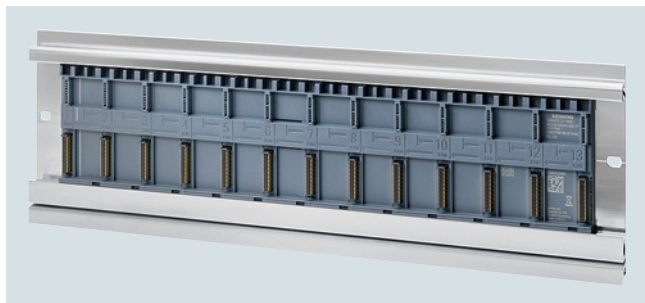

Active backplane bus in S7-1500 mounting rail

- Considerably enhances system availability:
 - Reaction-free hot swapping of I/O modules during operation; system remains in RUN mode when replacing one or more I/O modules
 - Reserve capacity (= gaps in system configuration) for later use
- Can also be used exclusively with ET 200MP and PROFINET
- Can be inserted in standard mounting rail of ET 200MP, replaces the U connector
- The comprehensive system functions of the ET 200 MP can still all be used
- Can be used with all PROFINET IO controllers by configuring via GSD file and PROFINET

Technical specifications

Article number	6ES7590-0BL00-0AA0 SIMATIC S7-1500 act. backplane/ 12 slot
General information	
Product type designation	Active backplane ST 1+12 slot
Product function	
• I&M data	Yes; I&M0 to I&M3
• Isochronous mode	Yes
• Prioritized startup	Yes
Engineering with	
• STEP 7 TIA Portal configurable/ integrated as of version	V16
• STEP 7 configurable/integrated as of version	V5.6 and higher
• PROFINET as of GSD version/ GSD revision	V2.34 / -
Hardware configuration	
Slots	
• Grid size	35 mm; Utilization of 25 mm-wide modules possible
• Number of slots	13
- of which for CPU, max.	0
- of which for IM, max.	1
- of which for PS, max.	12; Max. 2 PS per station
- of which for IO/CM/CP/TM, max.	12
- of which for F-IO, max.	12
• Number of single-width slots, max.	12

Article number	6ES7590-0BL00-0AA0 SIMATIC S7-1500 act. backplane/ 12 slot
Ambient conditions	
Ambient temperature during operation	
• horizontal installation, min.	-30 °C
• horizontal installation, max.	60 °C
• vertical installation, min.	-30 °C
• vertical installation, max.	40 °C
Altitude during operation relating to sea level	
• Installation altitude above sea level, max.	5 000 m; Restrictions for installation altitudes > 2 000 m, see manual
Dimensions	
Width	434 mm
Height	99 mm
Depth	14 mm
Weights	
Weight, approx.	352 g

Ordering data

Active backplane bus
With 12 slots for ET 200MP I/O modules for hot swapping; for insertion in the S7-1500 mounting rail.
Please order the S7-1500 mounting rail and slot covers separately.

Article No.
6ES7590-0BL00-0AA0

Accessories
Slot cover for active backplane bus

To protect against electrostatic discharge as well as provide mechanical stability on the S7-1500 mounting rail; 5 units per packing unit

Article No.
6ES7590-0CA00-0AA0

Overview



- For connection of ET 200M as IO device to PROFINET IO (via copper, RJ45)
- 2 versions:
 - IM 153-4 PN STANDARD
 - IM 153-4 PN HIGH FEATURE: additionally to the STANDARD version, operation of PROFI-safe F and HART modules
- Integrated 2-port switch
- 12 modules per station
- Usable I/O quantity structure: 192 bytes each
- Active backplane bus for hot swapping of modules optionally available
- Baud rate 10 Mbps / 100 Mbps (Autonegotiation/Full Duplex)
- I&M functions according to PNO Guideline Order No. 3.502, Version V1.1

Notes:

Micro Memory Card with min. 64 KB required if not all participants in the network support LLDP (Link Layer Discovery Protocol; neighbor detection).

SIPLUS extreme products are based on SIMATIC standard products. The contents listed here were taken from the respective standard products. SIPLUS extreme-specific information was added.

For technical documentation on SIPLUS, see:
<http://www.siemens.com/siplus-extreme>

Technical specifications

Article number	6AG1153-4AA01-7XB0	6AG1153-4BA00-7XB0
Based on	6ES7153-4AA01-0XB0 SIPLUS ET200M IM 153-4 PN IO	6ES7153-4BA00-0XB0 SIPLUS ET200M IM153-4 PN IO HF
Ambient conditions		
Ambient temperature during operation		
• min.	-25 °C; = Tmin	-40 °C; = Tmin; Startup @ -25 °C
• max.	70 °C; = Tmax; 60 °C @ UL/cUL, ATEX and FM use	70 °C; = Tmax; Tmax > 60 °C output current for backplane bus (5 V DC) max. 0.9 A
• At cold restart, min.		-25 °C
Ambient temperature during storage/transportation		
• min.	-40 °C	-40 °C
• max.	70 °C	70 °C
Altitude during operation relating to sea level		
• Installation altitude above sea level, max.	5 000 m	5 000 m
• Ambient air temperature-barometric pressure-altitude	Tmin ... Tmax at 1 140 hPa ... 795 hPa (-1 000 m ... +2 000 m) // Tmin ... (Tmax - 10 K) at 795 hPa ... 658 hPa (+2 000 m ... +3 500 m) // Tmin ... (Tmax -20 K) at 658 hPa ... 540 hPa (+3 500 m ... +5 000 m)	Tmin ... Tmax at 1 140 hPa ... 795 hPa (-1 000 m ... +2 000 m) // Tmin ... (Tmax - 10 K) at 795 hPa ... 658 hPa (+2 000 m ... +3 500 m) // Tmin ... (Tmax -20 K) at 658 hPa ... 540 hPa (+3 500 m ... +5 000 m)
Relative humidity		
• With condensation, tested in accordance with IEC 60068-2-38, max.	100 %; RH incl. condensation/frost (no commissioning under condensation conditions)	100 %; RH incl. condensation/frost (no commissioning under condensation conditions)
Resistance		
Use in stationary industrial systems		
- to biologically active substances according to EN 60721-3-3	Yes; Class 3B2 mold, fungus and dry rot spores (with the exception of fauna); Class 3B3 on request	Yes; Class 3B2 mold, fungus and dry rot spores (with the exception of fauna); Class 3B3 on request
- to chemically active substances according to EN 60721-3-3	Yes; Class 3C4 (RH < 75 %) incl. salt spray acc. to EN 60068-2-52 (severity degree 3); *	Yes; Class 3C4 (RH < 75 %) incl. salt spray acc. to EN 60068-2-52 (severity degree 3); *
- to mechanically active substances according to EN 60721-3-3	Yes; Class 3S4 incl. sand, dust, *	Yes; Class 3S4 incl. sand, dust, *

I/O systemsSIMATIC ET 200 systems for the control cabinet
SIMATIC ET 200M**Interface modules > SIPLUS ET 200M IM 153-4 PN IO****Technical specifications**

Article number	6AG1153-4AA01-7XB0	6AG1153-4BA00-7XB0
Based on	6ES7153-4AA01-0XB0 SIPLUS ET200M IM 153-4 PN IO	6ES7153-4BA00-0XB0 SIPLUS ET200M IM153-4 PN IO HF
Use on ships/at sea		
- to biologically active substances according to EN 60721-3-6	Yes; Class 6B2 mold and fungal spores (excluding fauna); Class 6B3 on request	Yes; Class 6B2 mold and fungal spores (excluding fauna); Class 6B3 on request
- to chemically active substances according to EN 60721-3-6	Yes; Class 6C3 (RH < 75 %) incl. salt spray acc. to EN 60068-2-52 (severity degree 3); *	Yes; Class 6C3 (RH < 75 %) incl. salt spray acc. to EN 60068-2-52 (severity degree 3); *
- to mechanically active substances according to EN 60721-3-6	Yes; Class 6S3 incl. sand, dust; *	Yes; Class 6S3 incl. sand, dust; *
Usage in industrial process technology		
- Against chemically active substances acc. to EN 60654-4	Yes; Class 3 (excluding trichlorethylene)	Yes; Class 3 (excluding trichlorethylene)
- Environmental conditions for process, measuring and control systems acc. to ANSI/ISA-71.04	Yes; Level GX group A/B (excluding trichlorethylene; harmful gas concentrations up to the limits of EN 60721-3-3 class 3C4 permissible); level LC3 (salt spray) and level LB3 (oil)	Yes; Level GX group A/B (excluding trichlorethylene; harmful gas concentrations up to the limits of EN 60721-3-3 class 3C4 permissible); level LC3 (salt spray) and level LB3 (oil)
Remark		
- Note regarding classification of environmental conditions acc. to EN 60721, EN 60654-4 and ANSI/ISA-71.04	* The supplied plug covers must remain in place over the unused interfaces during operation!	* The supplied plug covers must remain in place over the unused interfaces during operation!

Ordering data**Article No.****SIPLUS ET 200M IM 153-4 PN**

(Extended temperature range and exposure to media)

Slave interface for connecting an ET 200M to PROFINET for a maximum of 12 S7-300 modules

- Standard
- High Feature

6AG1153-4AA01-7XB0
6AG1153-4BA00-7XB0

Accessories**IE FC RJ45 plug 180****6AG1901-1BB10-7AA0**

180° cable outlet; 1 unit

Additional accessories

See SIMATIC ET 200M IM 153-4 PN interface module, catalog ST 70 · 2019, page 9/227

Ordering data	Article No.
Stainless steel enclosure IP65 for SIMATIC ET 200iSP	6DL2804- ■ ■ ■ ■ ■
I/O enclosure	
Surface casing in stainless steel, max. IP66, with mounting plate and equipotential bonding rail, empty enclosure for installation of ET 200iSP components ¹⁾	0
I/O device consisting of surface casing with installed ET 200iSP components ²⁾	1
I/O device consisting of surface casing with installed ET 200iSP and pneumatic components ²⁾	2
Device group	
Device group II, up to zone 1 (including zone 2)	A
Device group II, up to zone 21 (including zone 22)	D
Enclosure dimensions W x H x D (in mm)	
650 x 450 x 230, for 15 ET 200iSP modules in non-redundant configuration	D
950 x 450 x 230, for 25 ET 200iSP modules in non-redundant configuration	E
800 x 800 x 300, for 2 rows with max. 30 ET 200iSP modules	K
1000 x 1000 x 300, for 2 rows with max. 42 ET 200iSP modules	T
1000 x 1200 x 300, for 2 rows with max. 42 ET 200iSP modules	U
Cable entries/number	
M16 cable entries for signals, 3 rows, 39 or 66 units ³⁾ , 2 x M32 for supply voltage, 4 x M20 for bus cables	3
M20 cable entries for signals, 3 rows, 36 or 57 units ³⁾ , 2 x M32 for supply voltage, 4 x M20 for bus cables	4
M16 cable entries for signals, 5 rows, 65 or 110 units ³⁾ , 2 x M32 for supply voltage, 4 x M20 for bus cables	5
M20 cable entries for signals, 3 rows, 60 or 95 units ³⁾ , 2 x M32 for supply voltage, 4 x M20 for bus cables	6
Icotek cable entry strip IP65, for up to 45 or 90 signals ³⁾ , 2 x M32 for supply voltage, 4 x M20 for bus cables ⁴⁾	7
Cable entries/material	
Cable entry in plastic, black	0
Ambient operating temperatures: • Surface casing -40...+70 °C • I/O device -40 ... +xx °C ⁵⁾⁶⁾	
Cable entry in metal (nickel-plated brass)	1
Ambient operating temperatures: • Surface casing -40...+70 °C • I/O device -40 ... +xx °C ⁵⁾⁶⁾	
Cable entry in plastic, blue	2
Ambient operating temperatures: • Surface casing -40...+70 °C • I/O device -40 ... +xx °C ⁵⁾⁶⁾	
Icotek cable entry in plastic, gray HN-24 frame	3
Ambient operating temperatures: • Surface casing -40...+70 °C • I/O device -40 ... +xx °C ⁵⁾⁶⁾	

- ¹⁾ The supplied certificate is only valid for the empty enclosure.
²⁾ The included certificate is valid for the supplied enclosure including the installed components.
³⁾ Number of cable entries/signals depends on enclosure dimensions
⁴⁾ Installing these components reduces the degree of protection for the enclosure to IP65
⁵⁾ Maximum temperature depends on installed components.
⁶⁾ Minus temperatures down to -40 °C when heater installed.
This takes up 2 slots for ET 200iSP modules.

Note:

Depending on the cables used, other types and sizes of cable entries can be fitted (on request).

I/O systems

IO systems for heating elements
with integrated power outputs - modular design

SIPLUS HCS4200 heating control system > Central Interface Module (CIM)

Overview



The Central Interface Module (CIM) is the intelligent processor module of the SIPLUS HCS4200 heating control system.

Technical specifications

Article number	6BK1942-1AA00-0AA0 HCS CIM4210 PROFINET	6BK1942-1AA00-0AA1 HCS CIM4210C PROFINET	6BK1942-1BA00-0AA0 HCS CIM4210 PROFIBUS
General information			
Product type designation	CIM4210 PROFINET	CIM4210C PROFINET	CIM4210 PROFIBUS
Installation type/mounting			
Mounting type	Screw mounting to rack	Backplane mounting	Screw mounting to rack
Mounting position	vertical		
Type of ventilation	Forced ventilation	Self-ventilation	Forced ventilation
Supply voltage			
Type of supply voltage	DC		
Connection method			
• Design of electrical connection for supply voltage	Connector 2x 2-pin with tension spring connection		
- Connectable conductor cross-sections, solid	1x (0.2 ... 2.5 mm ²)		
- Connectable conductor cross-sections, finely stranded with wire end processing	1x (0.2 ... 2.5 mm ²)		
- Connectable conductor cross-sections for AWG cables	1x (26 ... 12)		
Power			
Active power input	3 W	8 W	3 W
Hardware configuration			
Type of power output connectable	POM4220		
Slots			
• Number of slots	1	2; POM4220	1
Interfaces			
Interfaces/bus type	PROFINET IO		PROFIBUS DP
PROFIBUS DP			
• Transmission rate, max.			12 Mbit/s
• Design of electrical connection of PROFIBUS interface			9-pin sub D socket
Supports protocol for PROFINET IO			
• Transmission rate, max.	100 Mbit/s		
• Design of electrical connection of PROFINET interface	2x RJ45		

Technical specifications

Article number	6BK1942-1AA00-0AA0	6BK1942-1AA00-0AA1	6BK1942-1BA00-0AA0
	HCS CIM4210 PROFINET	HCS CIM4210C PROFINET	HCS CIM4210 PROFIBUS
Protocols			
Supports protocol for PROFINET IO	Yes		No
PROFIBUS DP	No		Yes
Further protocols			
• EtherNet/IP	No		
Interrupts/diagnostics/ status information			
Number of status displays	3		
LED status display	LED green = ready, LED yellow = heating on/off, LED red = error display		
Isolation			
Overvoltage category	III		
Degree of pollution	2		
EMC			
EMC interference emission	Limit value in accordance with IEC 61000-6-4:2007 + A1:2011		
Electrostatic discharge acc. to IEC 61000-4-2	4 kV contact discharging, 8 kV air discharging		
Field-related interference acc. to IEC 61000-4-3	10 V/m (80 ... 1 000 MHz), 3 V/m (1.4 ... 2.0 GHz), 1 V/m (2.0 ... 2.7 GHz)		
Conducted interference due to burst acc. to IEC 61000-4-4	2 kV power supply lines, 2 kV PROFINET cables		2 kV power supply lines / 2 kV PROFIBUS cables
Conducted interference due to surge acc. to IEC 61000-4-5	DC supply lines: 0.5 kV symmetric and unsymmetric PROFINET cables: 1 kV unsymmetric		DC supply lines: 0.5 kV symmetrical and asymmetrical, PROFIBUS lines: 1 kV asymmetrical
Conducted interference due to high-frequency radiation acc. to IEC 61000-4-6	10 V (0.15 ... 80 MHz)		
Degree and class of protection			
IP degree of protection	IP20		
Standards, approvals, certificates			
Reference designation according to DIN EN 81346-2	K		
Ambient conditions			
Ambient temperature during operation			
• min.	0 °C		
• max.	55 °C		
Ambient temperature during storage/transportation			
• Storage, min.	-25 °C		
• Storage, max.	70 °C		
• Transportation, min.	-25 °C		
• Transportation, max.	70 °C		
Air pressure acc. to IEC 60068-2-13			
• Operation, min.	860 hPa		
• Operation, max.	1 080 hPa		
• Storage, min.	660 hPa		
• Storage, max.	1 080 hPa		
Altitude during operation relating to sea level			
• Installation altitude above sea level, max.	2 000 m		
Relative humidity			
• Operation at 25 °C, max.	95 %		
• Operation at 50 °C, max.	50 %; 95 % at 25 °C, decreasing linearly to 50 % at 50 °C		

I/O systems

I/O systems for heating elements
with integrated power outputs - modular design

SIPLUS HCS4200 heating control system > Central Interface Module (CIM)

Technical specifications

Article number	6BK1942-1AA00-0AA0 HCS CIM4210 PROFINET	6BK1942-1AA00-0AA1 HCS CIM4210C PROFINET	6BK1942-1BA00-0AA0 HCS CIM4210 PROFIBUS
Vibrations			
• Vibration resistance during operation acc. to IEC 60068-2-6	10 ... 58 Hz / 0.075 mm, 58 ... 150 Hz / 1 g		
• Vibration resistance during storage acc. to IEC 60068-2-6	5 ... 8.5 Hz / 3.5 mm, 8.5 ... 500 Hz / 1 g		
Shock testing			
• Shock resistance during operation acc. to IEC 60068-2-27	15 g / 11 ms / 3 shocks/axis		
• Shock resistance during storage acc. to IEC 60068-2-29	25 g / 6 ms / 1 000 shocks/axis		
Dimensions			
Width	43 mm	104 mm	43 mm
Height	285 mm	339 mm	285 mm
Depth	136 mm	296 mm	136 mm

Ordering data

	Article No.		Article No.
SIPLUS HCS4200 CIM4210 PROFINET Central Interface Module with PROFINET communication	6BK1942-1AA00-0AA0	Accessories	
SIPLUS HCS4200 CIM4210 compact version PROFINET Central Interface Module with PROFINET communication	6BK1942-1AA00-0AA1	SIPLUS HCS4200 connector set As spare part, consisting of 20 x 2-pin connectors (24 V DC power supply)	6BK1942-6FA00-0AA0
SIPLUS HCS4200 CIM4210 PROFIBUS Central Interface Module with PROFIBUS communication	6BK1942-1BA00-0AA0	SIPLUS HCS4000 temperature I/O module For recording temperatures using temperature sensors, thermocouples and pyrometers	6BK1900-0AA00-0AA0
		SIPLUS HCS4000 DI/DQ I/O module With 8 digital outputs and 8 configurable inputs/outputs	6BK1900-0BA00-0AA0
		SIPLUS HCS4000 U/I I/O module For current and voltage measurement (line voltage compensation)	6BK1900-0CA00-0AA0

I/O systems

IO systems for heating elements with integrated power outputs - modular design

SIPLUS HCS4300 heating control system > Power Output Module (POM)

Design



- Module (encapsulated) in a metal enclosure
- There are 6 versions:
 - POM4320 busbar mounting (IEC):
a current of up to 16 A can be used per output
 - POM4320 busbar mounting (UL):
a current of up to 15 A can be used per output
 - POM4320 rear panel mounting (IEC):
a current of up to 16 A can be used per output
 - POM4320 rear panel mounting (UL):
a current of up to 15 A can be used per output
 - POM4320 Highend busbar mounting:
a current of up to 60 A can be used per output
 - POM4320 Highend rear panel mounting:
a current of up to 60 A can be used per output
- Heat dissipation by fan fitted to top of module
- Internal serial interface
- Three diagnostics LEDs for displaying module faults
- POM4320: 9 diagnostics LEDs for displaying output errors.
- POM4320 Highend: 6 diagnostics LEDs for displaying output errors.

Technical specifications

Article number	6BK1943-2AA00-0AA2	6BK1943-2AH00-0AA0	6BK1943-2BA00-0AA2	6BK1943-2CA00-0AA2	6BK1943-2CH00-0AA0	6BK1943-2DA00-0AA2
	HCS POM4320 busbar mounting (IEC)	HCS POM4320 Highend busbar mounting	HCS POM4320 busbar mounting (UL)	HCS POM4320 panel mounting (IEC)	HCS POM4320 Highend panel mounting	HCS POM4320 panel mounting (UL)
General information						
Product type designation	POM4320 BUSBAR MOUNTING (IEC)	POM4320 Highend	POM4320 BUSBAR MOUNTING (UL)	POM4320 rear panel mounting (IEC)	POM4320 Highend	POM4320 rear panel mounting (UL)
Installation type/mounting						
Mounting type	Busbar mounting			Backplane mounting		
Mounting position	vertical					
Type of ventilation	Self-ventilation					
Supply voltage						
Type of supply voltage	AC					
Rated value (AC)	400 V	230 V	400 V		230 V	400 V
• Relative negative tolerance	10 %					
• Relative positive tolerance	30 %					
2nd rated value (AC)	480 V	277 V	480 V		277 V	480 V
• Relative negative tolerance	25 %					
• Relative positive tolerance	8 %					
3rd rated value (AC)		400 V			400 V	
• Relative negative tolerance	10 %					
• Relative positive tolerance	30 %					
4th rated value (AC)		480 V			480 V	
• Relative negative tolerance	25 %					
• Relative positive tolerance	8 %					
Line frequency						
• Rated value 50 Hz	Yes					
• Rated value 60 Hz	Yes					
• Relative symmetrical tolerance	5 %					

I/O systems

IO systems for heating elements
with integrated power outputs - modular design

SIPLUS HCS4300 heating control system > Power Output Module (POM)

Technical specifications

Article number	6BK1943-2AA00-0AA2	6BK1943-2AH00-0AA0	6BK1943-2BA00-0AA2	6BK1943-2CA00-0AA2	6BK1943-2CH00-0AA0	6BK1943-2DA00-0AA2
	HCS POM4320 busbar mounting (IEC)	HCS POM4320 Highend busbar mounting	HCS POM4320 busbar mounting (UL)	HCS POM4320 panel mounting (IEC)	HCS POM4320 Highend panel mounting	HCS POM4320 panel mounting (UL)
Mains buffering						
• Recovery time after power failure, typ.	1 s					
Connection method						
• Design of electrical connection for supply voltage	Busbar mounting, 3-pole + PE	Busbar adapter, 3-pole + N + PE	Busbar mounting, 3-pole + PE	Terminal, 3-pin	Terminal, 3-pole + N + PE	Terminal, 3-pin
- Connectable conductor cross-sections, solid				1x (1.5 ... 50 mm ²)		
- Connectable conductor cross-sections, finely stranded with wire end processing				1x (1.5 ... 35 mm ²)		
- Connectable conductor cross-sections for AWG cables				1x (16 ... 1)		
- Cable cross-sections for N		1x (0.2 ... 2.5 mm ²)			1x (0.2 ... 2.5 mm ²)	
Input voltage						
Design of the power supply	Power supply via CIM					
Power						
Active power input, max.	8 W	10 W	8 W		10 W	8 W
Power electronics						
Type of load	Ohmic load					
Power capacity, max.	57.6 kW; At 400 V AC	76.8 kW; At 400 V AC	64.8 kW; At 480 V AC	57.6 kW; At 400 V AC	76.8 kW; At 400 V AC	64.8 kW; At 480 V AC
• For phase against phase with fan at 40 °C, max.	57.6 kW; At 400 V AC	76.8 kW; At 400 V AC	64.8 kW; At 480 V AC	57.6 kW; At 400 V AC	76.8 kW; At 400 V AC	64.8 kW; At 480 V AC
• For phase against neutral with fan at 40 °C, max.		44.16 kW; At 230 V AC			44.16 kW; At 230 V AC	
Switching capacity current per phase, max.	83 A		80 A	83 A	105 A	80 A
Short-time withstand current (SCCR) acc. to UL 508A			100 kA			100 kA
Control of heating elements						
• Half-wave control	Yes					
• Soft start	Yes					
• Phase control	Yes					
Load connection type						
• Star connection with neutral conductor (single-phase)	No	Yes	No		Yes	No
• Open delta connection (single-phase)	Yes; Incoming fuse contained in the device	Yes; Incoming fuse in the device optionally possible	Yes; Incoming fuse contained in the device		Yes; Incoming fuse in the device optionally possible	Yes; Incoming fuse contained in the device
• Closed delta connection (3-phase)	No	Yes	No		Yes	No
• Star connection with neutral conductor (2-phase)	No					
• 2-pole switching	No	Yes; Phase - phase	No		Yes; Phase - phase	No
Setpoint input						
• Percent	Yes					
• Watts	No	Yes	No		Yes	No

Technical specifications

Article number	6BK1943-2AA00-0AA2	6BK1943-2AH00-0AA0	6BK1943-2BA00-0AA2	6BK1943-2CA00-0AA2	6BK1943-2CH00-0AA0	6BK1943-2DA00-0AA2
	HCS POM4320 busbar mounting (IEC)	HCS POM4320 Highend busbar mounting	HCS POM4320 busbar mounting (UL)	HCS POM4320 panel mounting (IEC)	HCS POM4320 Highend panel mounting	HCS POM4320 panel mounting (UL)
Heating power						
• Number of digital outputs	9	6; Possible parallel switching of 2 outputs	9		6; Possible parallel switching of 2 outputs	9
• Number of heating elements per output, max.	1	5	1		5	1
• Output voltage for heating power	400 V	230 V	400 V		230 V	400 V
• 2nd output voltage for heating power	480 V	277 V	480 V		277 V	480 V
• 3rd output voltage for heating power		400 V			400 V	
• 4th output voltage for heating power		480 V			480 V	
• Power carrying capacity per output, min.	200 W; At 400 V AC	1 200 W; At 400 V AC	200 W; At 480 V AC	200 W; At 400 V AC	1 200 W; At 400 V AC	200 W; At 480 V AC
• Power carrying capacity per output, max.	6 400 W; At 400 V AC	12 800 W; At 400 V AC	7 200 W; At 480 V AC	6 400 W; At 400 V AC	12 800 W; At 400 V AC	7 200 W; At 480 V AC
- for heating elements with high inrush current, max.	4 000 W; At 400 V AC	6 000 W; At 400 V AC	4 000 W; At 480 V AC	4 000 W; At 400 V AC	6 000 W; At 400 V AC	4 000 W; At 480 V AC
• Output current for heating power	16 A; max.	32 A; max.	15 A; max.	16 A; max.	32 A; max.	15 A; max.
• Melting I _{2t} value	250 A ² ·s		400 A ² ·s	250 A ² ·s		400 A ² ·s
• Design of short-circuit protection per output	Fuse 16 A	Melting fuse 32 A	Melting fuse 20 A	Fuse 16 A	Melting fuse 32 A	Melting fuse 20 A
• Design of overvoltage protection	Transil Diode					
Connection method						
• Design of electrical connection at output for heating and fan	Connector, 3-pole with spring-loaded connection	Plug, 3-pole, with operating lever	Connector, 3-pole with spring-loaded connection	Plug, 3-pole, with operating lever	Connector, 3-pole with spring-loaded connection	Connector, 3-pole with spring-loaded connection
- Connectable conductor cross-sections, solid	1x (0.2 ... 10 mm ²)	1x (0.75 ... 16 mm ²)	1x (0.2 ... 10 mm ²)	1x (0.75 ... 16 mm ²)	1x (0.2 ... 10 mm ²)	1x (0.2 ... 10 mm ²)
- Connectable conductor cross-sections, finely stranded with wire end processing	1x (0.25 ... 6 mm ²)	1x (0.75 ... 16 mm ²)	1x (0.25 ... 6 mm ²)	1x (0.75 ... 16 mm ²)	1x (0.25 ... 6 mm ²)	1x (0.25 ... 6 mm ²)
- Connectable conductor cross-sections for AWG cables, stranded	1x (24 ... 8)	1x (18 ... 4)	1x (24 ... 8)	1x (18 ... 4)	1x (24 ... 8)	1x (24 ... 8)
Interfaces						
Interfaces/bus type	system interface					
Interrupts/diagnostics/ status information						
Number of status displays	12	9	12		9	12
LED status display	LED green = ready, LED yellow = heating on/off, LED red = error display, LED red = error for each channel					
Diagnostics function	Voltage diagnostics	Voltage and current diagnosis	Voltage diagnostics		Voltage and current diagnosis	Voltage diagnostics
Diagnostic messages						
• Fuse blown	Yes					
• Load failure	Yes					
• Triac error	Yes					
• Switch-off threshold for internal device temperature	Yes					
• Parallel-connected heating elements	No	Yes	No		Yes	No
• Rotating field fault	Yes					
• Communication error	Yes					
• Supply voltage not connected	Yes					
• Line voltage outside the permissible range	Yes					
• Frequency outside the permissible range	Yes					
• Fault current too high	No	Yes	No		Yes	No

I/O systems

IO systems for heating elements
with integrated power outputs - modular design

SIPLUS HCS4300 heating control system > Power Output Module (POM)

Technical specifications

Article number	6BK1943-2AA00-0AA2	6BK1943-2AH00-0AA0	6BK1943-2BA00-0AA2	6BK1943-2CA00-0AA2	6BK1943-2CH00-0AA0	6BK1943-2DA00-0AA2
	HCS POM4320 busbar mounting (IEC)	HCS POM4320 Highend busbar mounting	HCS POM4320 busbar mounting (UL)	HCS POM4320 panel mounting (IEC)	HCS POM4320 Highend panel mounting	HCS POM4320 panel mounting (UL)
Integrated Functions						
Monitoring functions						
• Temperature monitoring	Yes					
• Type of temperature monitoring	NTC thermistor					
Measuring functions						
• Voltage measurement	Yes					
• Current measurement	No	Yes	No	Yes	No	No
• Fault current detection	No	Yes; For 2-pole switching	No	Yes; For 2-pole switching	No	No
Potential separation						
Design of electrical isolation between the outputs	Optocoupler and/or protective impedance between main circuit and PELV No					
Isolation						
Overvoltage category	III					
Degree of pollution	2					
EMC						
EMC interference emission	Limit value in accordance with IEC 61000-6-4:2007 + A1:2011					
Electrostatic discharge acc. to IEC 61000-4-2	4 kV contact discharge / 8 kV air discharge					
Field-related interference acc. to IEC 61000-4-3	10 V/m (80 ... 1 000 MHz), 3 V/m (1.4 ... 2.0 GHz), 1 V/m (2.0 ... 2.7 GHz)					
Conducted interference due to burst acc. to IEC 61000-4-4	2 kV power supply lines, 2 kV load lines					
Conducted interference due to surge acc. to IEC 61000-4-5	on supply and load lines: 1 kV symmetric, 2 kV unsymmetric					
Conducted interference due to high-frequency radiation acc. to IEC 61000-4-6	10 V (0.15 ... 80 MHz)					
Degree and class of protection						
IP degree of protection	IP20					
Standards, approvals, certificates						
Reference designation according to DIN EN 81346-2	Q					
Ambient conditions						
Ambient temperature during operation						
• min.	0 °C					
• max.	55 °C					
Ambient temperature during storage/transportation						
• Storage, min.	-25 °C					
• Storage, max.	70 °C					
• Transportation, min.	-25 °C					
• Transportation, max.	70 °C					
Air pressure acc. to IEC 60068-2-13						
• Operation, min.	860 hPa					
• Operation, max.	1 080 hPa					
• Storage, min.	660 hPa					
• Storage, max.	1 080 hPa					
Altitude during operation relating to sea level						
• Installation altitude above sea level, max.	2 000 m					
Relative humidity						
• Operation at 25 °C, max.	95 %					
• Operation at 50 °C, max.	50 %; 95 % at 25 °C, decreasing linearly to 50 % at 50 °C					

Technical specifications

Article number	6BK1943-2AA00-0AA2	6BK1943-2AH00-0AA0	6BK1943-2BA00-0AA2	6BK1943-2CA00-0AA2	6BK1943-2CH00-0AA0	6BK1943-2DA00-0AA2
	HCS POM4320 busbar mounting (IEC)	HCS POM4320 Highend busbar mounting	HCS POM4320 busbar mounting (UL)	HCS POM4320 panel mounting (IEC)	HCS POM4320 Highend panel mounting	HCS POM4320 panel mounting (UL)
Vibrations						
• Vibration resistance during operation acc. to IEC 60068-2-6	10 ... 58 Hz / 0.075 mm, 58 ... 150 Hz / 1 g					
• Vibration resistance during storage acc. to IEC 60068-2-6	5 ... 8.5 Hz / 3.5 mm, 8.5 ... 500 Hz / 1 g					
Shock testing						
• Shock resistance during operation acc. to IEC 60068-2-27	15 g / 11 ms / 3 shocks/axis					
• Shock resistance during storage acc. to IEC 60068-2-29	25 g / 6 ms / 1 000 shocks/axis					
Dimensions						
Width	104 mm					
Height	340 mm			344 mm		
Depth	250 mm			217 mm		

Ordering data

Ordering data	Article No.	Ordering data	Article No.
SIPLUS HCS4300 POM4320		Accessories	
Power output module with 9 outputs for connecting resistive loads		SIPLUS HCS4300 connecting cable from POM to POM	
IEC, busbar mounting, redesign version with enhanced interference immunity	6BK1943-2AA00-0AA2	• Consisting of 10 items, 100 mm long	6BK1943-5AA00-0AA0
UL, busbar mounting, redesign version with enhanced interference immunity and 100 kA SCCR	6BK1943-2BA00-0AA2	• Consisting of 10 items, 250 mm long	6BK1943-5BA00-0AA0
IEC, rear panel mounting, redesign version with enhanced interference immunity	6BK1943-2CA00-0AA2	• Consisting of 10 items, 1000 mm long	6BK1943-5CA00-0AA0
UL, rear panel mounting, redesign version with enhanced interference immunity and 100 kA SCCR	6BK1943-2DA00-0AA2	• Consisting of 10 items, 1500 mm long	6BK1943-5DA00-0AA0
POM4320 Highend	6BK1943-2AH00-0AA0	HCS4300 connector set for POM4320	6BK1943-6AA00-0AA0
POM4320 Highend	6BK1943-2CH00-0AA0	• Consisting of 10 x 3-pin connectors	
		Spare fuse, 16 A/500 V, for POM4320	6BK1943-6BA00-0AA0
		Fan as spare part POM4320	6BK1700-2GA00-0AA0
		Spare fuse, 32 A/690 V, for POM4320 Highend	6BK1943-6EA00-0AA0
		HCS4300 connector set for POM4320 Highend	6BK1943-6AF00-0AA0
		Fan as spare part POM4320 Highend	6BK1943-6GA00-0AA0
		HCS Jumper POM4320 Highend	6BK1943-6HA00-0AA0

I/O systems

Network transitions

Power Line Booster

Overview

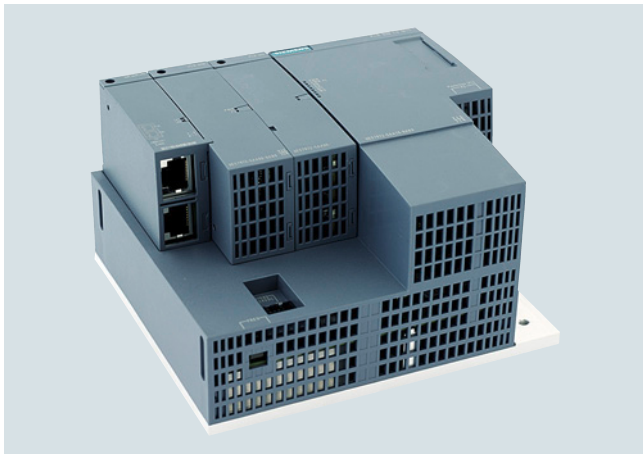

The Power Line Booster system is a communication system for general data transmission on conductive media. It enables Ethernet-based communication links between stationary system controls and mobile plant units: The transmission media can be sliding contact systems (graphite/copper on copper) such as in electric monorail conveyors or flexible cables such as the ones used in crane systems as well as slip ring transmitters. The Power Line Booster is designed for operation in industrial environments and supports the use of the proven SIMATIC PROFINET automation components on mobile plant units.

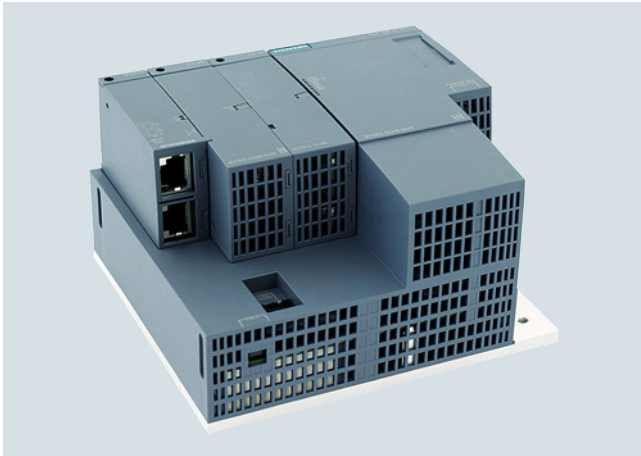
Overview

SIMATIC PLB BM LV M/S

- SIMATIC PLB BM LV M/S basic module; for accommodating
 - the Power Line Booster modem module,
 - the empty module and
 - the BusAdapter module RJ-45 ET200SP BA 2xRJ45 or BusAdapter Fast Connect ET200SP BA 2xFC

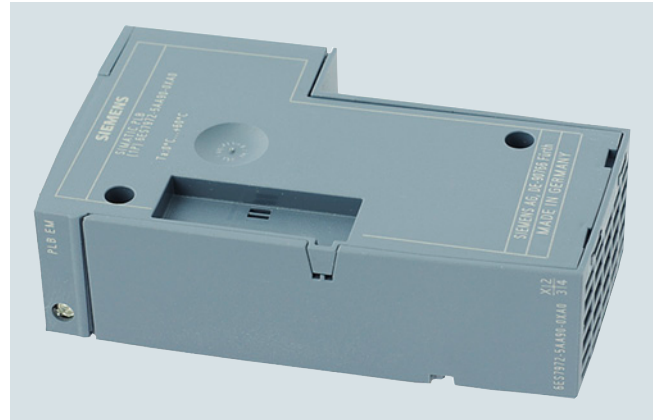

SIMATIC PLB EM

- SIMATIC PLB EM empty module; to cover the module bay and the DIP switches of the PLB BM

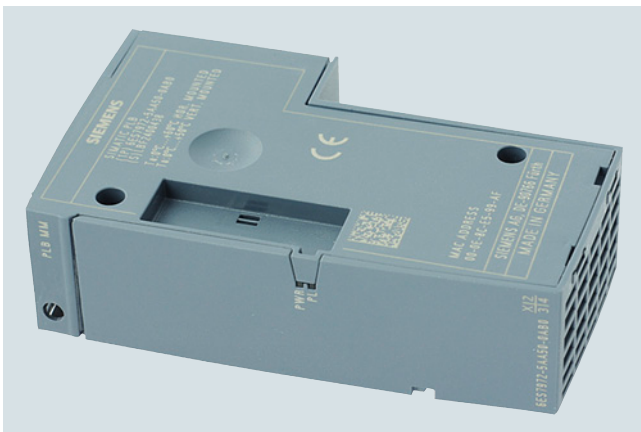

SIMATIC PLB MM

- SIMATIC PLB MM modem module; modulates or demodulates the Ethernet data frames into a form that is suitable for the "Powerline" transmission medium (e.g. sliding contact lines).

Ordering data
Article No.
Article No.
SIMATIC PLB BM LV M/S basic module

To accommodate the Power Line Booster modem module, the empty module and the BusAdapter module RJ-45 ET200SP BA 2xRJ45 or BusAdapter Fast Connect ET200SP BA 2xFC

6ES7972-5AA10-0AB0
SIMATIC PLB MM modem module

Modulates or demodulates the Ethernet data frames into a form that is suitable for the "Powerline" transmission medium (e.g. sliding contact lines).

6ES7972-5AA51-0AB0
SIMATIC PLB EM modem module

to cover the module bay and the DIP switches of the PLB BM

6ES7972-5AA80-0XA0

I/O systems

Network transitions
Power Line Booster

Accessories**Overview**

- SIMATIC PLB TC termination module;
to terminate both ends of the communication cable of a segment
- SIMATIC PLB connection cable;
the connection cables in a powerline system have a strong impact on the signal attenuation and cause poles in the frequency range used. This is why the selection of cables also has an effect on the maximum configuration limit. The PLB connection cable, with a length of 8 m, is optimized for PLB use. The following are available:
 - Connection cable without plug, length 8 m
 - Connection cable with plug at one end, length 8 m
 - Connection cable with 2 plugs

Ordering data**Article No.****SIMATIC PLB TC termination module****6ES7972-5AB00-0XA0**

to terminate both ends of the communication cable of a segment

SIMATIC PLB connecting cable

Length 8 m

- Without a plug
- With a plug on one side
- With two plugs

6ES7903-1AH40-0AB0**6ES7903-1AH41-0AB0****6ES7903-1AH42-0AB0**

Overview



- For data exchange between PROFINET and CAN Bus 2.0A/B or CANopen manager or slave (according to CiA 301 & 302)
- CANopen features:
 - Node / lifeguarding
 - Heartbeat
 - SYNC (producer / consumer)
- Integrated in TIA via HSP, TIA Portal V14 or higher
- PROFINET switch and 9-pin D-sub plug integrated for CAN
- Up to 126 CAN nodes
- 512 receiver/transmitter PDOs
- Galvanic isolation between the two networks
- Diagnostic interrupts
- Controllers supported: S7-1200, S7-1500, ET 200SP, Open Controller

Note:

SIPLUS extreme products are based on SIMATIC standard products. The contents listed here were taken from the respective standard products. SIPLUS extreme-specific information was added.

For technical documentation on SIPLUS, see:

<http://www.siemens.com/siplus-extreme>

Technical specifications

Article number	6AG1620-0AA00-7AA0
Based on	6BK1620-0AA00-0AA0 SIPLUS PN/CAN LINK
Ambient conditions	
Ambient temperature during operation	
• horizontal installation, min.	-40 °C; = Tmin (incl. condensation/frost)
• horizontal installation, max.	70 °C; = Tmax
Ambient temperature during storage/transportation	
• min.	-40 °C
• max.	85 °C
Altitude during operation relating to sea level	
• Installation altitude above sea level, max.	5 000 m
• Ambient air temperature-barometric pressure-altitude	Tmin ... Tmax at 1 140 hPa ... 795 hPa (-1 000 m ... +2 000 m) // Tmin ... (Tmax - 10 K) at 795 hPa ... 658 hPa (+2 000 m ... +3 500 m) // Tmin ... (Tmax -20 K) at 658 hPa ... 540 hPa (+3 500 m ... +5 000 m)
Relative humidity	
• With condensation, tested in accordance with IEC 60068-2-38, max.	100 %; incl. condensation / frost permitted (no commissioning under condensation conditions)

Article number	6AG1620-0AA00-7AA0
Based on	6BK1620-0AA00-0AA0 SIPLUS PN/CAN LINK
Resistance	
Coolants and lubricants	
- Resistant to commercially available coolants and lubricants	Yes; Incl. diesel and oil droplets in the air
Use in stationary industrial systems	
- to biologically active substances according to EN 60721-3-3	Yes; Class 3B2 mold, fungus and dry rot spores (with the exception of fauna); Class 3B3 on request
- to chemically active substances according to EN 60721-3-3	Yes; Still being prepared
- to mechanically active substances according to EN 60721-3-3	Yes; Class 3S4 incl. sand, dust, *
Use on ships/at sea	
- to biologically active substances according to EN 60721-3-6	Yes; Class 6B2 mold and fungal spores (excluding fauna); Class 6B3 on request
- to chemically active substances according to EN 60721-3-6	Yes; Class 6C3 (RH < 75 %) incl. salt spray acc. to EN 60068-2-52 (severity degree 3); *
- to mechanically active substances according to EN 60721-3-6	Yes; Class 6S3 incl. sand, dust, *

I/O systems

Network transitions

SIPLUS PN/CAN LINK**Technical specifications**

Article number	6AG1620-0AA00-7AA0
Based on	6BK1620-0AA00-0AA0 SIPLUS PN/CAN LINK
Usage in industrial process technology	
- Against chemically active substances acc. to EN 60654-4	Yes; Class 3 (excluding trichlorethylene)
- Environmental conditions for process, measuring and control systems acc. to ANSI/ISA-71.04	Yes; Level GX group A/B (excluding trichlorethylene; harmful gas concentrations up to the limits of EN 60721-3-3 class 3C4 permissible); level LC3 (salt spray) and level LB3 (oil)
Remark	
- Note regarding classification of environmental conditions acc. to EN 60721, EN 60654-4 and ANSI/ISA-71.04	* The supplied plug covers must remain in place over the unused interfaces during operation!
Conformal coating	
• Coatings for printed circuit board assemblies acc. to EN 61086	Yes; Class 2 for high availability
• Protection against fouling acc. to EN 60664-3	Yes; Type 1 protection
• Military testing according to MIL-I-46058C, Amendment 7	Yes; Discoloration of coating possible during service life
• Qualification and Performance of Electrical Insulating Compound for Printed Board Assemblies according to IPC-CC-830A	Yes; Conformal coating, Class A

Ordering data

SIPLUS PN/CAN Link

PROFINET network transition according to CAN Bus 2.0A/B, CANopen manager according to CiA301/302, CANopen slave according to CiA301/302; IP20

Ambient temperature -40 ... +70 °C (+85 °C for 10 min.)

Article No.**6AG1620-0AA00-7AA0**

SIMATIC control systems



11/2

**SIMATIC TDC
multiprocessor control system**

11/2

SM500 DI/DQ I/O module

SIMATIC control systems

SIMATIC TDC multiprocessor control system

SM500 DI/DQ I/O module

Overview

The SM500 DI/DQ I/O module provides digital inputs and outputs.

Function

- 16 digital outputs
- 16 digital inputs
- 6 LEDs for status displays

The signals are not directly connected to the I/O modules; instead, they are connected via the following interface module, available separately:

- SU13 interface module with SC63 cable for all signals (without signal conversion, no galvanic isolation)
- SB10, SB70, SB71, SU12 interface modules with SC62 cable for digital outputs (with galvanic isolation)
- SB10, SB60, SB61, SU12 interface modules with SC62 cable for digital outputs (with galvanic isolation)

Technical specifications

Power supply

Voltage / Power supply (at 25°C)	+5 V typically 0.4 A +3.3 V typically 0.05 A
----------------------------------	---

Typical power loss	3 W
--------------------	-----

Required space / width	1 slot
------------------------	--------

Weight	0.6 kg
--------	--------

Digital outputs

Number	16
Galvanic isolation	Only through optional interface modules

External power supply:	
• Nominal voltage	24 V
• Permissible range	20.4 V to 28.8 V
• Short-term	35 V for max. 0.5 s
• Max. current consumption, without load	40mA

Output voltage range:	
• At 0 signal, max.	3 V
• At 1 signal, min.	ext. supply voltage -2.5 V

Output current:	
• At 0 signal, min.	- 20 µA
• At 1 signal	
- Rated value	50 mA
- Permissible range, max.	100 mA

Delay time	100 µs
------------	--------

Max. switching frequency of the outputs under resistive load	6 kHz
--	-------

Short-circuit protection to	
• Mass	yes
• Ext. power supply	No

Max. short-circuit current	250 mA
----------------------------	--------

Total current of outputs (up to 60°C)	16 x 50mA
---------------------------------------	-----------

Limiting of inductive cut-off voltage.	External power supply +1 V
--	----------------------------

Digital inputs

Number	16
Galvanic isolation	Only through optional interface modules

Input voltage:	
• Nominal voltage	24 V
• For 0 signal	-1 V to +6 V
• For 1 signal	+13.5 V to +33 V

Input current:	
• At 0 signal	0 mA
• At 1 signal	3 mA

Delay time	100 µs
------------	--------

Ordering data

Article No.

SM500 DI/DQ I/O module

6DD1640-0AH1

16 DI/16 DQ; 6 LEDs

Software for SIMATIC Controllers

**12/2**

12/2

12/2

12/4

12/7

12/7

12/9

12/11

12/12

12/13

12/15

12/15

12/16

12/17

TIA PortalPLC programming

STEP 7 Basic (TIA Portal)

STEP 7 Professional (TIA Portal)

STEP 7 (TIA Portal) options

- STEP 7 Safety (TIA Portal)

- S7-PLCSIM Advanced

- Target 1500S for Simulink

- SIMATIC Safe Kinematics

- OPC UA S7-1200/S7-1500

TIA Portal options

TIA Portal Multiuser Engineering

TIA Portal Test Suite

SIMATIC ProDiag

12/18

12/18

12/18

12/21

12/21

STEP 7 V5.xBasic software and editors

STEP 7 Professional

Options for programming and design

CFC

12/23

12/23

12/23

Software for common tasksFor network planning/commissioning

PROFINET Asset Management

PRONETA Professional

Software for SIMATIC Controllers

TIA Portal

PLC programming

STEP 7 Basic (TIA Portal)

Overview

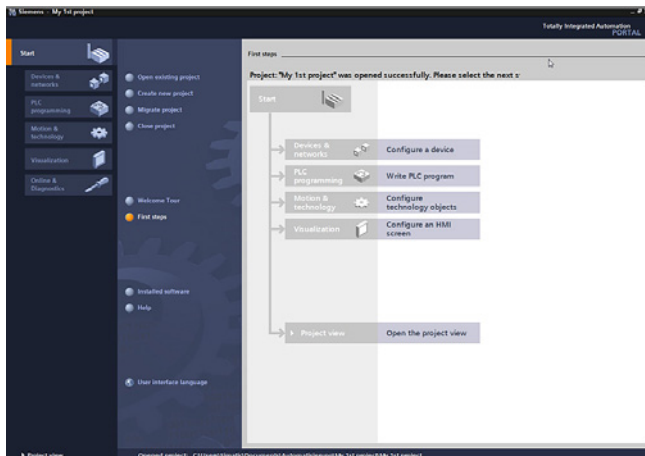

STEP 7 Basic V16 (TIA Portal), portal view

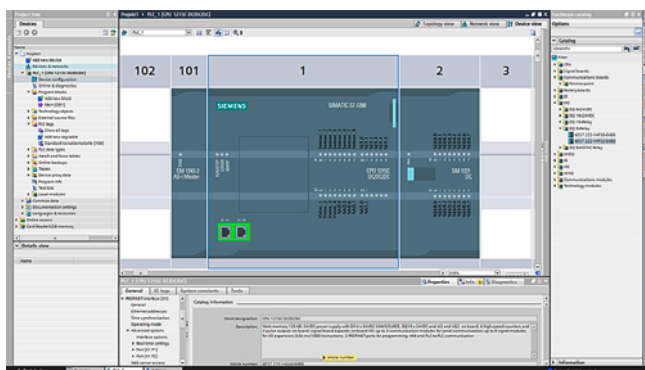

STEP 7 Basic V16 (TIA Portal), device view: configuring and parameterizing in realistic photo-quality representation

Intuitive, efficient and future-oriented - the engineering software for programming SIMATIC controllers

SIMATIC STEP 7 Basic V16 is the engineering system for the SIMATIC S7-1200.

STEP 7 Basic V16 is based on the Totally Integrated Automation Portal (TIA Portal) central engineering framework which offers users a uniform, efficient and intuitive solution to all automation tasks.

New with V16

- Direct code comparison between blocks from a project/reference project and blocks from a TIA Portal library (for types and copy templates, in the project library or a global library, and also between different versions of one type)
- Multilingual SCL comments
- Cross-device trace
- Cycle control for PLCSIM (pause, simulation duration, ...)
- Language packs for Japanese, Korean and Russian which can be installed subsequently
- Interface for the connection of external version management systems
- Simple expandability of the TIA Portal by means of TIA Portal add-ins

Licensing

- STEP 7 Basic V16 is supplied with a floating license. The floating license allows the software to be used on any number of computers. This means one user per license can use the software independently of the computer used and without being tied to a specific workstation. The number of existing licenses determines the number of computers on which the software can be used simultaneously.
- Existing STEP 7 Basic licenses versions V11 to V15 can be upgraded to V16. This requires an upgrade license.
- A STEP 7 Basic V16 license can be upgraded to a STEP 7 Professional V16 license with a PowerPack.

You can find more information on the Software Update Service, license types, online software delivery and handling your SW licenses with the Automation License Manager here:

<http://www.siemens.com/simatic-licenses>

Technical specifications

STEP 7 Basic V16 (TIA Portal)	
Type of license	Floating license
Software class	A
Current version	V16
Target system	SIMATIC S7-1200
Operating systems	Windows 7 (64-bit) <ul style="list-style-type: none"> • Windows 7 Home Premium SP1 • Windows 7 Professional SP1 • Windows 7 Enterprise SP1 • Windows 7 Ultimate SP1 Windows 10 (64-bit) <ul style="list-style-type: none"> • Windows 10 Home Version 1809, 1903 • Windows 10 Professional Version 1809, 1903 • Windows 10 Enterprise Version 1809, 1903 • Windows 10 IoT Enterprise 2015 LTSB • Windows 10 IoT Enterprise 2016 LTSB • Windows 10 IoT Enterprise 2019 LTSC Windows Server (64-bit) <ul style="list-style-type: none"> • Windows Server 2012 R2 StdE (full installation) • Windows Server 2016 Standard (full installation) • Windows Server 2019 Standard (full installation)
Recommended PC hardware	
Computer	SIMATIC Field PG M5 Advanced or higher (or comparable PC)
Processor	Intel Core i5-6440EQ (up to 3.4 GHz)
RAM	16 GB or more (min. 8 GB, 32 GB for large projects)
Hard disk	SSD with at least 50 GB storage space available
Network	1 Gbit (for multi-user)
Screen	15.6" full HD display (1920 x 1080 or higher)

Technical specifications**Compatibility with other SIMATIC products**

STEP 7 V16 can be installed on a PC in parallel with other versions of STEP 7 V11 to V15.1, STEP 7 V5.4 or higher, STEP 7 Micro/WIN, WinCC flexible (from 2008) and WinCC (V7.0 SP2 or higher).

Projects as from TIA Portal project version V13 SP1 can be directly upgraded to V16. Upgrading of projects from previous project versions (V11 ... V13) is carried out on the basis of the TIA Portal products (e.g. STEP 7) used in the project in version V13 SP1 or V13 SP2 (latest update recommended).

Important note

TIA Portal project versions V13 SP1.. V15.1 are upgraded with TIA Portal V16 to the project version V16. If you need to edit a TIA Portal project version V13 SP1.. V15, we recommend an additional installation of the corresponding software to TIA Portal V16. The license purchased for V16 is also valid for all older TIA Portal versions.

Program code and hardware configuration from STEP 7 V5.4 SP5 can be migrated directly to a TIA Portal V16 project with STEP 7 V16.

Ordering data	Article No.	Article No.
STEP 7 Basic V16 Target system: SIMATIC S7-1200 Requirement: Windows 7 Home Premium SP1 Windows 7 Professional SP1 Windows 7 Enterprise SP1 Windows 7 Ultimate SP1 Windows 10 Home Version 1809, 1903 Windows 10 Professional Version 1809, 1903 Windows 10 Enterprise Version 1809, 1903 Windows 10 IoT Enterprise 2015 LTSB Windows 10 IoT Enterprise 2016 LTSB Windows 10 IoT Enterprise 2019 LTSC Windows Server 2012 R2 StdE (full installation) Windows Server 2016 Standard (full installation) Windows Server 2019 Standard (full installation) Type of delivery: German, English, Chinese, Italian, French, Spanish		Software Update Service For a period of 12 months and for a fixed price, the customer is automatically provided with all upgrades and Service Packs for each installed software package. The contract is automatically extended by a further year unless canceled at least 12 weeks prior to expiration. Requires the current software version
STEP 7 Basic V16, floating license	6ES7822-0AA06-0YA5	Software Update Service (Standard Edition)²⁾ The delivery is implemented according to the number of ordered SUS products (e.g. 10 upgrade packages with 10 DVDs, 10 USB flash drives, etc.) • STEP 7 Basic
STEP 7 Basic V16, floating license, software download including license key¹⁾ Email address required for delivery	6ES7822-0AE06-0YA5	Software Update Service (Compact Edition)²⁾ The delivery items are combined. For several contracts, only 1 package with 1 data storage medium set, 1 USB flash drive with the corresponding number of licenses and the corresponding number of CoLs will be supplied. Delivery items to be combined must be ordered as one item. • STEP 7 Basic
STEP 7 Basic/Professional V16, trial license	6ES7822-1AA06-0YA7	Software Update Service (Download)²⁾ Upgrades and Service Packs are available for downloading. Email address required for delivery • STEP 7 Basic
Upgrade STEP 7 Basic V11...V15 to STEP 7 Basic V16, floating license	6ES7822-0AA06-0YE5	6ES7822-0AA00-0YL0
Upgrade STEP 7 Basic V11...V15 to STEP 7 Basic V16, floating license, software download incl. license key¹⁾ Email address required for delivery	6ES7822-0AE06-0YE5	6ES7822-0AA00-0YM0
PowerPack STEP 7 Basic V16 to STEP 7 Professional V16, floating license	6ES7822-1AA06-0YC5	6ES7822-0AE00-0YY0
PowerPack STEP 7 Basic V16 to STEP 7 Professional V16, floating license, software download including license key¹⁾ Email address required for delivery	6ES7822-1AE06-0YC5	

¹⁾ For up-to-date information and download availability, see: <http://www.siemens.com/tia-online-software-delivery>

²⁾ For more information on the Software Update Service, see catalog ST 70 · 2019, page 11/2.

Software for SIMATIC Controllers

TIA Portal
PLC programming

STEP 7 Professional (TIA Portal)

Overview

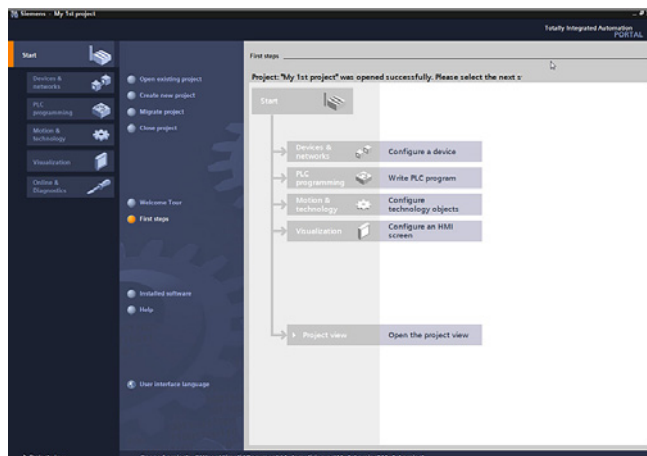

STEP 7 Professional V16 (TIA Portal), portal view

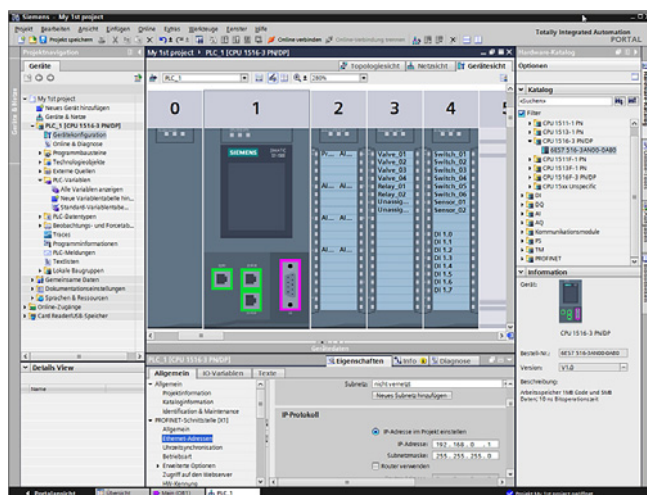

STEP 7 Professional V16 (TIA Portal), device view: configuring and parameterizing in realistic photo-quality representation

Intuitive, efficient and future-oriented - the engineering software for programming the SIMATIC controllers

SIMATIC STEP 7 Professional V16 is the engineering system for the SIMATIC S7-1200, S7-1500, S7-300, S7-400 controllers, WinAC and Software Controllers.

STEP 7 V16 is based on the Totally Integrated Automation Portal (TIA Portal) central engineering framework, which offers users a uniform, efficient and intuitive solution for all automation tasks.

New with V16

- Functional extensions to software units (TIA Portal Openness support, access to PLC variables from one unit to another unit)
- Direct code comparison between blocks from a project/reference project and blocks from a TIA Portal library (for types and copy templates, in the project library or a global library, and also between different versions of one type)
- Multilingual SCL comments
- Cross-device trace
- Cycle control for PLCSIM (pause, simulation duration, ...)
- Language packs for Japanese, Korean and Russian which can be installed subsequently
- Interface for the connection of external version management systems
- Simple expandability of the TIA Portal by means of TIA Portal add-ins

Licenses

- STEP 7 Professional V16 is supplied with a STEP 7 Professional V16 floating license. The floating license allows the software to be used on any number of computers. This means one user per license can use the software independently of the computer used and without being tied to a specific workstation. The number of existing licenses determines the number of computers on which the software can be used simultaneously.
- Existing STEP 7 Professional licenses versions V11 to V15 can be upgraded to V16. This requires an upgrade license.
- The user receives a combo license when upgrading from STEP 7 V5.x. The combo license enables engineering to be performed both on the STEP 7 V 5.x and the STEP 7 V16 platform.
- The STEP 7 Basic V16 license can be upgraded to a STEP 7 Professional V16 license with a PowerPack

You can find more information on the Software Update Service, license types, online software delivery and handling your software licenses with the Automation License Manager here:

<http://www.siemens.com/simatic-licenses>

Technical specifications

STEP 7 Professional V16 (TIA Portal)	
Type of license	Floating license
Software class	A
Current version	V16
Target system	SIMATIC S7-1200, S7-1500, S7-300, S7-400, WinAC, software controllers
Operating systems	<p>Windows 7 (64-bit)</p> <ul style="list-style-type: none"> Windows 7 Professional SP1 Windows 7 Enterprise SP1 Windows 7 Ultimate SP1 <p>Windows 10 (64-bit)</p> <ul style="list-style-type: none"> Windows 10 Professional Version 1809, 1903 Windows 10 Enterprise Version 1809, 1903 Windows 10 IoT Enterprise 2015 LTSB Windows 10 IoT Enterprise 2016 LTSB Windows 10 IoT Enterprise 2019 LTSC <p>Windows Server (64-bit)</p> <ul style="list-style-type: none"> Windows Server 2012 R2 StdE (full installation) Windows Server 2016 Standard (full installation) Windows Server 2019 Standard (full installation)
Recommended PC hardware	
Computer	SIMATIC Field PG M5 Advanced or higher (or comparable PC)
Processor	Intel Core i5-6440EQ (up to 3.4 GHz)
RAM	16 GB or more (min. 8 GB, 32 GB for large projects)
Hard disk	SSD with at least 50 GB storage space available
Network	1 Gbit (for multi-user)
Screen	15.6" full HD display (1920 x 1080 or higher)

Compatibility with other SIMATIC products

STEP 7 V16 can be installed on a PC in parallel with other versions of STEP 7 V11 to V15.1, STEP 7 V5.4 or higher, STEP 7 Micro/WIN, WinCC flexible (from 2008) and WinCC (V7.0 SP2 or higher).

Projects as from TIA Portal project version V13 SP1 can be directly upgraded to V16. Upgrading of projects from previous project versions (V11 ... V13) is carried out on the basis of the TIA Portal products (e.g. STEP 7) used in the project in version V13 SP1 or V13 SP2 (latest update recommended).

Important note

TIA Portal project versions V13 SP1.. V15.1 are upgraded with TIA Portal V16 to the project version V16. If you need to edit a TIA Portal project version V13 SP1.. V15, we recommend an additional installation of the corresponding software to TIA Portal V16. The license purchased for V16 is also valid for all older TIA Portal versions.

Program code and hardware configuration from STEP 7 V5.4 SP5 can be migrated directly to a TIA Portal V16 project with STEP 7 V16.

Ordering data

Article No.

STEP 7 Professional V16

Target system:
SIMATIC S7-1200, S7-1500, S7-300, S7-400, WinAC

Requirement:
Windows 7 Professional SP1
Windows 7 Enterprise SP1
Windows 7 Ultimate SP1
Windows 10 Professional Version 1809, 1903
Windows 10 Enterprise Version 1809, 1903
Windows 10 IoT Enterprise 2015 LTSB
Windows 10 IoT Enterprise 2016 LTSB
Windows 10 IoT Enterprise 2019 LTSC
Windows Server 2012 R2 StdE (full installation)
Windows Server 2016 Standard (full installation)
Windows Server 2019 Standard (full installation)

Type of delivery:
German, English, Chinese, Italian, French, Spanish

STEP 7 Professional V16, floating license

6ES7822-1AA06-0YA5

STEP 7 Professional V16, floating license, software download including license key ¹⁾

6ES7822-1AE06-0YA5

Email address required for delivery

STEP 7 Professional V16/2017 Combo, floating license

6ES7810-5CC13-0YA5

STEP 7 Professional V16/2017 Combo, floating license, software download including license key ¹⁾

6ES7810-5CE13-0YB5

Email address required for delivery

STEP 7 Professional V16, trial license

6ES7822-1AA06-0YA7

Conversion package STEP 7 Professional V16

Only valid if ordered together with Software Update Service 6ES7 810-5CC04-0YE2 (STEP 7 Professional and STEP 7 Professional in TIA Portal).

- PowerPack and upgrade STEP 7 V5.6 to STEP 7 Professional V16/2017 Combo, floating license. STEP 7 Software Update Service is a prerequisite.
- PowerPack and upgrade from STEP 7 V5.6 to STEP 7 Professional V16/2017 Combo, floating license. STEP 7 Software Update Service is a prerequisite. Software download including license key ¹⁾ Email address required for delivery

6ES7822-1AA06-0XC2

6ES7822-1AE06-0XC2

¹⁾ For up-to-date information and download availability, see: <http://www.siemens.com/tia-online-software-delivery>

Software for SIMATIC Controllers

TIA Portal

PLC programming

STEP 7 Professional (TIA Portal)

Ordering data

Article No.

Upgrade STEP 7 Professional V11...15 to STEP 7 Professional V16 or STEP 7 Professional V11...V15/201x Combo to V16/2017 Combo or STEP 7 Professional 2006...2010 to V16/2017 Combo, floating license

6ES7822-1AA06-0YE5

Upgrade STEP 7 Professional V11...15 to STEP 7 Professional V16 or STEP 7 Professional V11...V15/201x Combo to V16/2017 Combo or STEP 7 Professional 2006...2010 to V16/2017 Combo, floating license
Software download including license key¹⁾

6ES7822-1AE06-0YE5

Email address required for delivery

PowerPack STEP 7 Professional V16 Trial 365 to STEP 7 Prof. V16, floating license.

6ES7822-1BE06-0YC5

Only valid if ordered together with Software Update Service
6ES7 822-1AE00-0YY0
(STEP 7 Professional V1x)
Prerequisite is a STEP 7 V15 Trial 365 license.
License key download ¹⁾
Email address required for delivery

50 hours of engineering with STEP 7 Professional Combo, WinCC Professional (incl. WinCC flexible 2008) and STEP 7 Safety Advanced (incl. Distributed Safety), floating license
Software download incl. license key¹⁾

6ES7823-1GE06-0YA5

Email address required for delivery

PowerPack and upgrade from STEP 7 V5.4 to V5.6 to STEP 7 Professional V16/2017 Combo, floating license

6ES7822-1AA06-0XC5

PowerPack and upgrade from STEP 7 V5.4 to V5.6 to STEP 7 Professional V16/2017 Combo, floating license
Software download including license key¹⁾

6ES7822-1AE06-0XC5

Email address required for delivery

Article No.

Software Update Service

For a period of 12 months and for a fixed price, the customer is automatically provided with all upgrades and Service Packs for each installed software package. The contract is automatically extended by a further year unless canceled at least 12 weeks prior to expiration.
Requires the current software version

Software Update Service (Standard Edition)²⁾

The delivery is implemented according to the number of ordered SUS products (e.g. 10 upgrade packages with 10 DVDs, 10 USB flash drives, etc.)

- STEP 7 Professional in the TIA Portal
- STEP 7 Professional and STEP 7 Professional in the TIA Portal

6ES7822-1AA00-0YL5

6ES7810-5CC04-0YE2

Software Update Service (Compact Edition)²⁾

The delivery items are combined. For several contracts, only 1 package with 1 data storage medium set, 1 USB flash drive with the corresponding number of licenses and the corresponding number of CoLs will be supplied.

Delivery items to be combined must be ordered as one item.

- STEP 7 Professional in the TIA Portal
- STEP 7 Professional and STEP 7 Professional in the TIA Portal

6ES7822-1AA00-0YM5

6ES7810-5CC00-0YM2

Software Update Service (Download)²⁾

Upgrades and Service Packs are available for downloading.

Email address required for delivery

- STEP 7 Professional V1x
- STEP 7 Professional and STEP 7 Professional in the TIA Portal

6ES7822-1AE00-0YY0

6ES7810-5CC04-0YY2

¹⁾ For up-to-date information and download availability, see: <http://www.siemens.com/tia-online-software-delivery>

²⁾ For more information on the Software Update Service, see catalog ST 70 · 2019, page 11/2.

Overview

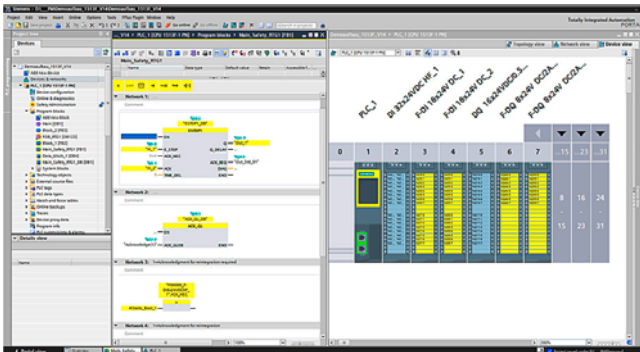

STEP 7 Safety Advanced, configuration and programming

- For creating safety-related programs on the STEP 7 user interface
- For seamless and easy to use integration of safety-related functions into the standard automation
- All the required configuration and programming tools are integrated into the STEP 7 user interface and utilize a common project structure
- STEP 7 Safety Basic option package for parameter assignment and programming of the fail-safe S7-1200
- STEP 7 Safety Advanced option package for all fail-safe TIA SIMATIC controller classes (S7-1200, S7-1500, S7-1500 Software Controller, S7-300, S7-400, WinAC)

Licensing

- The engineering software can be installed on multiple computers. The number of existing licenses determines the number of computers on which the software can be used simultaneously (floating license).
- STEP 7 Safety Basic is a subset of STEP 7 Safety Advanced for programming the fail-safe S7-1200 F Basic Controller.
- Powerpacks can be used to upgrade an existing STEP 7 Safety Basic license.
- Combo licenses allow you to choose between programming with the predecessor product S7 Distributed Safety and STEP 7 Safety Advanced.
- An upgrade to a combo license is offered for the latest version of S7 Distributed Safety.
- Software Update Service (SUS) contracts can be concluded for both STEP 7 Safety Basic and STEP 7 Safety Advanced.

You can find more information on the Software Update Service, license types, online software delivery and handling your software licenses with the Automation License Manager here:

<http://www.siemens.com/simatic-licenses>

There are Software Update Service contracts (SUS) available for both STEP 7 Safety Basic and STEP 7 Safety Advanced.

Ordering data

Article No.

STEP 7 Safety Advanced V16

Task:

Engineering tool for configuring and programming fail-safe user programs for SIMATIC S7-1200 FC, S7-1500F, S7-1500F Software Controller, S7-300F, S7-400F, WinAC RTX F, ET 200SP F Controller and the fail-safe ET 200SP, ET 200MP, ET 200S, ET 200M, ET 200iSP, ET 200pro and ET 200eco I/O

Requirement:

STEP 7 Professional V16

Note:

As from TIA Portal V16, the SIMATIC STEP 7 Safety software is an integral part of the SIMATIC STEP 7 product setup. The functionality of SIMATIC STEP 7 Safety is activated by means of the license key supplied in each case.

Floating license for 1 user;
license key on USB flash drive

6ES7833-1FA16-0YA5

Floating license for 1 user,
license key for download²⁾;
email address required for delivery

6ES7833-1FA16-0YH5

Software Update Service
(Standard Edition)¹⁾

6ES7833-1FC00-0YX2

The delivery is implemented according to the number of ordered SUS products (e.g. 10 upgrade packages with 10 DVDs, 10 USB flash drives, etc.).
Requires the current software version.

STEP 7 Safety Advanced V16
Combo

Delivery includes STEP 7 Safety Advanced V16 and S7 Distributed Safety V5.4 SP5 Update 2

Floating Combo license for 1 user;
software and documentation on DVD;
license key on USB flash drive

6ES7833-1FC16-0YA5

Floating Combo license for 1 user;
software, documentation and license key for download²⁾;
email address required for delivery

6ES7833-1FC16-0YH5

Software Update Service

Software Update Service
(Compact Edition)¹⁾

6ES7833-1FC00-0YM2

The delivery items are combined. For several contracts, only 1 package with 1 data storage medium set, 1 USB flash drive with the corresponding number of licenses and the corresponding number of CoLs will be supplied. The deliveries that are to be grouped together must be ordered as a single item.
Requires the current software version.

Minimum order quantity: 3 units

Software Update Service
(Download)¹⁾

6ES7833-1FC00-0YY0

Requires the current software version.

Email address required for delivery

¹⁾ For more information on the Software Update Service, see catalog ST 70 · 2019, page 11/2.

Software for SIMATIC Controllers

TIA Portal

PLC programming

STEP 7 (TIA Portal) options > STEP 7 Safety (TIA Portal)

Ordering data

Article No.

Article No.

STEP 7 Safety Advanced Upgrade

Note:

As from TIA Portal V16, the SIMATIC STEP 7 Safety software is an integral part of the SIMATIC STEP 7 product setup. The functionality of SIMATIC STEP 7 Safety is activated by means of the license key supplied in each case.

Upgrade from Distributed Safety V5.4 SP5 or STEP 7 Safety Advanced V11..V15 (Combo) to STEP 7 Safety Advanced V16 (Combo) for parallel use of the versions; upgrade of combo license for 1 user; license key on USB flash drive

6ES7833-1FA16-0YF5

Upgrade from Distributed Safety V5.4 SP5 or STEP 7 Safety Advanced V11..V15 (Combo) to STEP 7 Safety Advanced V16 (Combo) for parallel use of the versions; upgrade of combo license for 1 user; license key for download²⁾; email address required for delivery

6ES7833-1FA16-0YY5

STEP 7 Safety Advanced PowerPack

PowerPack STEP 7 Safety Basic V16 to STEP 7 Safety Advanced V16; floating license for 1 user; license key on USB flash drive

6ES7833-1FA16-0YC5

PowerPack STEP 7 Safety Basic V16 to STEP 7 Safety Advanced V16; floating license for 1 user; license key for download²⁾; email address required for delivery

6ES7833-1FA16-0YJ5

STEP 7 Safety Basic V16

Task:

Engineering tool for configuring fail-safe user programs for SIMATIC S7-1200 FC

Requirement:

STEP 7 Basic V16 and higher

Note:

As from TIA Portal V16, the SIMATIC STEP 7 Safety software is an integral part of the SIMATIC STEP 7 product setup. The functionality of SIMATIC STEP 7 Safety is activated by means of the license key supplied in each case.

Floating license for 1 user; license key on USB flash drive

6ES7833-1FB16-0YA5

Floating license for 1 user; license key for download²⁾; email address required for delivery

6ES7833-1FB16-0YH5

STEP 7 Safety Basic Upgrade

Note:

As from TIA Portal V16, the SIMATIC STEP 7 Safety software is an integral part of the SIMATIC STEP 7 product setup. The functionality of SIMATIC STEP 7 Safety is activated by means of the license key supplied in each case.

Upgrade from STEP 7 Safety Basic V13 SP1...V15 to STEP 7 Safety Basic V16 for parallel use of the versions; upgrade license for 1 user; license key on USB flash drive

6ES7833-1FB16-0YE5

Upgrade from STEP 7 Safety Basic V13 SP1...V15 to STEP 7 Safety Basic V16 for parallel use of the versions; upgrade license for 1 user; software, license key for download²⁾; email address required for delivery

6ES7833-1FB16-0YK5

Software Update Service (Standard Edition)¹⁾

6ES7833-1FD00-0YX2

The delivery is implemented according to the number of ordered SUS products (e.g. 10 upgrade packages with 10 DVDs, 10 USB flash drives, etc.). Requires the current software version.

Software Update Service (Compact Edition)¹⁾

6ES7833-1FD00-0YM2

The delivery items are combined. For several contracts, only 1 package with 1 data storage medium set, 1 USB flash drive with the corresponding number of licenses and the corresponding number of CoLs will be supplied. The deliveries that are to be grouped together must be ordered as a single item. Requires the current software version.

Minimum order quantity: 3 units

Software Update Service (Download)¹⁾

6ES7833-1FD00-0YN2

Requires the current software version.

Email address required for delivery

¹⁾ For more information on the Software Update Service, see catalog ST 70 · 2019, page 11/2.

²⁾ For up-to-date information and download availability, see: <http://www.siemens.com/tia-online-software-delivery>

Overview

With SIMATIC S7-PLCSIM Advanced, virtual controllers can be used for simulation of S7-1500 and ET 200SP controllers and for extensive function simulation.

The virtual controllers can also be tested and validated in conjunction with a plant/machine. An extensive API is available for interfacing plant/machine simulations.

New with V3.0

- S7-PLCSIM Advanced V3.0 now also supports the simulation of applications that were created with the ODK development package without the need for changes to be made to the STEP 7 program and the hardware configuration in the TIA Portal project. This extends the list of supported types of CPU:
 - CPU 1518(F)-4 PN/DP ODK
 - CPU 1518(F)-4 PN/DP MFP
- Supported function libraries for the real-time environment are:
 - CPU function library: Original Shared Object, SO files as for the hardware CPUs (the SO files for ODK are not know-how protected)
 - S7-PLCSIM Advanced function library (Windows Sync): a 32-bit Windows DLL for ODK Runtime, a 64-bit Windows DLL for ODK Runtime.
- New API functions:
 - RunAutodiscover();
The API was extended with the option to search for distributed runtimes in the network. This further improves the usability in complex test scenarios.
 - CleanupStoragePath();
The API now also supports the deletion of virtual memory cards (local and remote) in order to free up memory space in automated test scenarios, for example.

Licensing

- The engineering software can be installed on multiple computers. The number of existing licenses determines the number of computers on which the software can be used simultaneously (floating license). For each license, the use of two simultaneously started S7-PLCSIM Advanced instances is permitted.
- An upgrade to version 3.0 is available for users of the previous 1.0/2.x versions.
- It is possible to conclude Software Update Service (SUS) contracts.

You can find more information on the Software Update Service, license types, online software delivery and handling your software licenses with the Automation License Manager here:

<http://www.siemens.com/simatic-licenses>

Technical specifications

Minimum requirements for use

Hardware / software	Requirements
Processor	<ul style="list-style-type: none"> • One logical Intel Core™ i7-6820EQ for each started instance • At least one additional core for the operating system • At least one additional core for additional active applications
RAM	<ul style="list-style-type: none"> • 1 GB for each started instance • At least 4 GB for the Windows operating system • Additional RAM work memory according to the requirements of the remaining active applications
Free hard disk space	5 GB
Operating systems (64-bit version)	<ul style="list-style-type: none"> • Windows 7 Home Premium SP1 • Windows 7 Professional SP1 • Windows 7 Enterprise SP1 • Windows 7 Ultimate SP1 • Windows 10 Home Version 1809 & 1903 • Windows 10 Pro Version 1809 & 1903 • Windows 10 Enterprise Version 1809 & 1903 • Windows 10 IoT Enterprise 2016 LTSC • Windows 10 IoT Enterprise 2019 LTSC • Windows Server 2012 R2 StdE (full installation) • Windows Server 2016 Standard (full installation) • Windows Server 2019 Standard (full installation)
Screen resolution	min. 1024 x 768

Compatibility with other products

- S7-PLCSIM Advanced V3.0 and S7-PLCSIM V16 can be installed and operated on the same PC or the same virtual machine. Communication between the two applications cannot be simulated.
- Compatible with TIA portal projects from versions V14 to V16
- Support of the CPU firmware versions V1.8 to V2.8

Software for SIMATIC Controllers

TIA Portal

PLC programming

STEP 7 (TIA Portal) options > S7-PLCSIM Advanced

Ordering data	Article No.	Ordering data	Article No.
SIMATIC S7-PLCSIM Advanced V3.0 Option for simulation of S7-1500 and ET 200SP Floating license, software and documentation on DVD; license key on USB flash drive Floating license, software, documentation and license key for download ¹⁾ Email address required for delivery	6ES7823-1FA02-0YA5 6ES7823-1FE02-0YA5	Software Update Service²⁾ For a period of 12 months and for a fixed price, the customer is automatically provided with all upgrades and Service Packs for each installed software package. The contract is automatically extended by a further year unless canceled at least 12 weeks prior to expiration. Requires the current software version. Software Update Service: Upgrades and service packs are provided in the form of DVDs, USB flash drives etc.	6ES7823-1FA00-0YL5 6ES7823-1FE00-0YL5
Upgrade Upgrade SIMATIC S7-PLCSIM Advanced V1.0/V2.x to V3.0, floating license Upgrade SIMATIC S7-PLCSIM Advanced V1.0/V2.x to V3.0, floating license for download ¹⁾ ; Email address required for delivery	6ES7823-1FA02-0YE5 6ES7823-1FE02-0YE5	Software Update Service (Download) ¹⁾ Upgrades and Service Packs are available for downloading. Email address required for delivery	

¹⁾ For up-to-date information and download availability, see: <http://www.siemens.com/tia-online-software-delivery>

²⁾ For more information on the Software Update Service, see catalog ST 70 · 2019, page 11/2.

Overview

The SIMATIC Target 1500S is an add-on for the Simulink® software from The MathWorks. This makes it possible to also use model-based design with MATLAB® and Simulink for SIMATIC S7-1500 controllers. For this purpose, executable code for all ODK-compatible S7-1500 controllers (S7-1500 Software Controllers, ET 200SP Open Controllers, CPU 1518 ODK/MFP and PLCSIM Advanced as of V3.0) is generated directly from Simulink via the Target 1500S.

New with V4.0

- Simplified workflow thanks to better TIA Portal integration: The improved integration offers automatic configuration for external mode, inclusion in the S7 program and automatic download to the controller. This means that an almost completely automated workflow of code generation and transfer to the CPU is possible.
- Software in the loop (SiL) simulation in conjunction with SIMATIC S7-PLCSIM Advanced V3.0. The connection between Simulink and PLCSIM Advanced is based on S-Functions (see Siemens Industry Online Support entry: <https://support.industry.siemens.com/cs/ww/en/view/109749187>).
- Improved display of Simulink models on the CPU web server. Stateflow® models and their active states are also displayed. When a scope is used in the model, the Y-axis is automatically scaled

Licensing

- The engineering software can be installed on multiple computers. The number of existing licenses determines the number of computers on which the software can be used simultaneously (floating license)
- SIMATIC Target 1500S™ for Simulink® V4.0 is available as a standalone product or in a bundle with the SIMATIC S7-1500 Software Controller Open Development Kit.
- An upgrade to latest versions is available for previous versions

You can find more information on the Software Update Service, license types, online software delivery and handling your SW licenses with the Automation License Manager here:

<http://www.siemens.com/simatic-licenses>

Technical specifications

Requirements at the MATLAB end

MATLAB 2019b (64-bit) or more recent version	<ul style="list-style-type: none"> • MATLAB 9.7 • MATLAB Coder 4.3 • Simulink 10.0 • Simulink Coder 9.2
--	---

Requirements at the SIMATIC end

SIMATIC ODK 1500S V2.0/V2.5	Must be installed together with target 1500S, MATLAB and Simulink on the same PC
STEP 7 Professional as of V15.1	For configuration of the S7-1500 CPUs, not essentially on the same PC as the target 1500S
Supported CPUs	<ul style="list-style-type: none"> • CPU 1507S(F) with firmware V2.0 or higher • CPU 1515SP PC (F) with firmware V2.0 or higher • CPU 1518 (F) ODK/MFP • S7-PLCSIM Advanced as of V3.0

Ordering data

Article No.

SIMATIC Target 1500S for Simulink V4.0 Download incl. license key ¹⁾ Email address required for delivery	6ES7823-1BE03-0YA5
Upgrade Upgrade of SIMATIC Target 1500S for Simulink V2.0...V3.0 to V4.0, download incl. license key ¹⁾ Email address required for delivery	6ES7823-1BE03-0YE5
SIMATIC Target + ODK 1500S bundle Download incl. license key ¹⁾ Email address required for delivery	6ES7823-1BE13-0YA0

¹⁾ For up-to-date information and download availability, see: <http://www.siemens.com/tia-online-software-delivery>

Software for SIMATIC Controllers

TIA Portal

PLC programming

STEP 7 (TIA Portal) options > SIMATIC Safe Kinematics

Overview

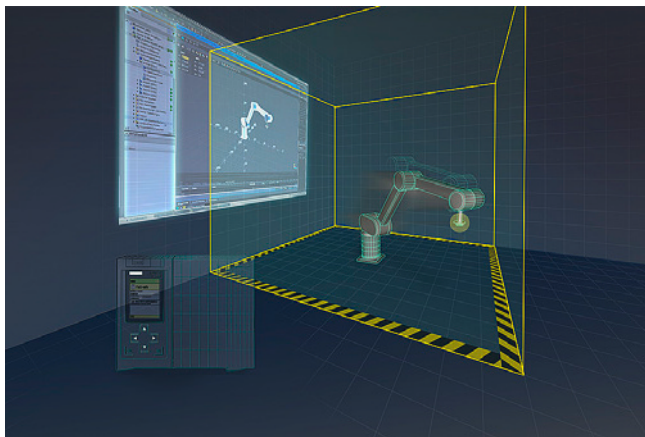

- For reliable monitoring of motion in the space of predefined kinematics with up to 4 interpolating axes; both the velocity of specific points on the kinematic, e.g. of the Tool Center Point (TCP), and work, protection and signal zones can be reliably monitored.
- Contains a fail-safe block library that can be integrated in the STEP 7 Safety Advanced V15.1 programming environment and can be connected on the input and output side.
- The following kinematics are available in version V1.0:
 - Cartesian portal
 - Roller picker (vertical)
 - Articulated arm
 - SCARA
- Optional package for TIA Portal V15.1
- System requirements:
 - CPU S7-1517TF-3 PN/DP
 - TIA Portal V15.1
 - STEP 7 Safety Advanced V15.1
 - Lower-level drive system: SINAMICS S120 drives as of firmware V5.1 with Safety Integrated Advanced Functions

Licensing

- The software is supplied with a single license. A license is required for each CPU on which SIMATIC Safe Kinematics runs.
- To use SIMATIC Safe Kinematics, licenses are also required for SIMATIC STEP 7 Professional, SIMATIC Safety Advanced and SINAMICS Safety Integrated Advanced Functions (for each monitored axis).
- The software can only be ordered via Online Software Delivery (OSD). The download contains a license certificate and the TIA Portal installation setup for SIMATIC Safe Kinematics.

Ordering data

SIMATIC Safe Kinematics V1.0

Option for reliable monitoring of motion of predefined kinematics with up to 4 interpolating axes

Requirement:

STEP 7 Professional V15.1,
STEP 7 Safety Advanced V15.1;
can be run on
CPU 1517TF-3 PN/DP

Single Runtime License
Download¹⁾;
contains license certificate and
installation setup for SIMATIC Safe
Kinematics block library;
Email address required for delivery

Article No.

6ES7823-0FE00-1AA0

¹⁾ For up-to-date information and download availability, see:
<http://www.siemens.com/tia-online-software-delivery>

Overview

The vendor- and platform-independent OPC Unified Architecture (UA) is the communication standard for Industry 4.0 and is the standard mechanism for accessing SIMATIC S7-1500 and S7-1200 data from non-Siemens devices.

New with V16 and S7-1200 (firmware V4.4)

- OPC UA server on S7-1200 CPUs with following functionality:
 - Browsing
 - Read/Write
 - Subscription
 - Companion specification

New with V16 and S7-1500 (firmware V2.8)

- OPC UA server restart on TIA Portal download now only in the case of relevant changes
- Improved diagnostic options in the TIA Portal
- Additional entries can be configured for the CPU diagnostic buffer in the TIA Portal
- Server interfaces or Companion Specs can now also be modeled in the TIA Portal

Licensing

An OPC UA server or OPC UA client is available on the target systems (CPUs) and is activated using runtime licenses.

Runtime licenses are offered in three levels for different target systems:

Target system	OPC UA S7-1200 Basic	OPC UA S7-1500 Small	OPC UA S7-1500 Medium	OPC UA S7-1500 Large
S7-1200 CPUs	Yes	No	No	No
ET 200SP CPU 1510SP/1512SP/1515SP (Open Controller) S7-1500 CPU 1511/1513 CPU 1504D Drive Controller	No	Yes	Yes	Yes
ET 200pro CPU 1516pro S7-1500 CPU 1515/1516 PLC 1507S software	No	No	Yes	Yes
S7-1500 CPU 1517/1518/1508S CPU 1507D Drive Controller	No	No	No	Yes

The runtime license includes the certificate for OPC UA (server and client) and can be run on the respective target systems including F, C and T/TF as from firmware V2.0 (client V2.6).

You can find more information on the Software Update Service, license types, online software delivery and handling your software licenses with the Automation License Manager here:

<http://www.siemens.com/simatic-licenses>

Technical specifications

Can be used for	
SIMATIC OPC UA S7-1200	For all S7-1200 CPUs from firmware V4.4
SIMATIC OPC UA S7-1500	For all S7-1500 CPUs and ET 200SP CPUs with firmware V2.0 or higher (incl. S/F/T versions) and PLCSIM Advanced

Software for SIMATIC Controllers

TIA Portal

PLC programming

STEP 7 (TIA Portal) options > OPC UA S7-1200/S7-1500

Ordering data	Article No.	Article No.	
<p>SIMATIC OPC UA S7-1200 Basic</p> <p>Single runtime license; can run on all S7-1200 CPUs (incl. F) from firmware V4.4</p> <p>License certificate for OPC UA server (data access)</p> <p>Download incl. license certificate for OPC UA server (data access) ¹⁾</p> <p>Email address required for delivery</p>	<p>6ES7823-0BA00-2BA0</p> <p>6ES7823-0BE00-2BA0</p>	<p>SIMATIC OPC UA S7-1500 Medium</p> <p>Single runtime license; can run on ET 200pro CPU 1516pro, ET 200SP CPU 1510SP/1512SP/ 1515SP (Open Controller), S7-1500 CPU 1511/1513/1515/ 1516, Software PLC 1507S, CPU 1504D Drive Controller</p> <p>License certificate for OPC UA server (data access and OPC UA client)</p> <p>Download incl. license certificate for OPC UA server (data access and OPC UA client) ¹⁾</p> <p>Email address required for delivery</p> <p>SIMATIC OPC UA S7-1500 Large</p> <p>Single runtime license; can run on ET 200pro CPU 1516pro, ET 200SP CPU 1510SP/1512SP/ 1515SP (Open Controller), S7-1500 CPU 1511/1513/1515/ 1516/1517/1518, Software PLC 1507S, 1508S, CPU 1504D Drive Controller, CPU 1507D</p> <p>License certificate for OPC UA server (data access and OPC UA client)</p> <p>Download incl. license certificate for OPC UA server (data access and OPC UA client) ¹⁾</p> <p>Email address required for delivery</p>	<p>6ES7823-0BA00-1CA0</p> <p>6ES7823-0BE00-1CA0</p> <p>6ES7823-0BA00-1DA0</p> <p>6ES7823-0BE00-1DA0</p>
<p>SIMATIC OPC UA S7-1500 Small</p> <p>Single runtime license; can run on ET 200SP CPU 1510SP/1512SP/1515SP (Open Controller), S7-1500 CPU 1511/1513, CPU 1504D Drive Controller</p> <p>License certificate for OPC UA server (data access and OPC UA client)</p> <p>Download incl. license certificate for OPC UA server (data access and OPC UA client) ¹⁾</p> <p>Email address required for delivery</p>	<p>6ES7823-0BA00-1BA0</p> <p>6ES7823-0BE00-1BA0</p>		

¹⁾ For up-to-date information and download availability, see:
<http://www.siemens.com/tia-online-software-delivery>

Overview

TIA Portal Multiuser Engineering allows several users to work on the same project simultaneously. This results in a significant reduction in configuration times, and projects can be commissioned faster.

The basic principle:

The project administration is handled by an autonomous server application. This can be installed independent of a TIA Portal.

New with V16

- Central storage of projects on the TIA Portal project server (formerly Multiuser Server)
- License-free exclusive engineering mode, enabling an individual user to work with a single project on the TIA Portal project server
- The asynchronous commissioning mode permits considerably faster loading onto the devices during commissioning

Licensing

- The software can be installed on multiple computers. The number of existing licenses determines the number of computers on which the software can be used simultaneously (floating license).
- The software is part of the STEP 7/WinCC (TIA Portal) DVD and/or of the program download; a license key is required for activation.
- An upgrade to version V16 is available for users of the previous V14...V15 versions.
- It is possible to conclude Software Update Service (SUS) contracts.

You can find more information on the Software Update Service, license types, online software delivery and handling your software licenses with the Automation License Manager here:

<http://www.siemens.com/simatic-licenses>

Ordering data**Article No.****TIA Portal Multiuser Engineering V16**

Software is a component of STEP 7/WinCC as of V16. Only the Certificates of License (CoL) are delivered with the license.

Data storage medium package, floating license, license key on USB flash drive

6ES7823-1AA06-0YA5

Download incl. license key, floating license; license key for download ¹⁾

6ES7823-1AE06-0YA5

Email address required for delivery

Upgrade

Software is a component of STEP 7/WinCC as of V16. Only the Certificates of License (CoL) are delivered with the license.

Upgrade TIA Portal Multiuser Engineering V14...V15 to V16, floating license; license key on USB flash drive

6ES7823-1AA06-0YE5

Upgrade TIA Portal Multiuser Engineering V14...V15 to V16, floating license; license key for download ¹⁾

6ES7823-1AE06-0YE5

Email address required for delivery

Software Update Service ²⁾

Data storage medium package

6ES7823-1AA00-0YL5

Download ¹⁾

6ES7823-1AE00-0YL5

Email address required for delivery

¹⁾ For up-to-date information and download availability, see: <http://www.siemens.com/tia-online-software-delivery>

²⁾ For more information on the Software Update Service, see catalog ST 70 · 2019, page 11/2.

Software for SIMATIC Controllers

TIA Portal

TIA Portal options

TIA Portal Test Suite

Overview

- Software to support quality assurance of automation programs in the TIA Portal
- Contains tools for checking the programming style and for creating test routines for software modules:
 - Styleguide Checker:
 - to ensure a unified programming style, rule sets with programming guidelines in the TIA Portal project can be defined as well as their compliance regularly checked.
 - Application test:
 - to check the correct processing of individual logic blocks or entire S7-1500 applications, test routines with function tests can be created in a TIA Portal project and subsequently executed and validated with help of SIMATIC S7-PLCSIM Advanced V3.0.

Licensing

- The software can be installed on multiple computers. The number of existing licenses determines the number of computers on which the software can be used simultaneously (floating license).
- The application tests created with the Test Suite can only be executed in conjunction with SIMATIC S7-PLCSIM Advanced V3.0 including Update 1 or higher. An additional SIMATIC S7-PLCSIM Advanced V3.0 license is, however, not necessary for this.
- There is also the option of completing a Software Update Service.

You can find more information on the Software Update Service, license types, online software delivery and handling your SW licenses with the Automation License Manager here:

<http://www.siemens.com/simatic-licenses>

Ordering data

Article No.

TIA Portal Test Suite Advanced V16

Software to support quality assurance of automation programs in the TIA Portal;
Software can exclusively be used together with STEP 7 Prof. / WinCC V16 including Update 1 or higher. To execute application tests, the SIMATIC S7-PLCSIM Advanced V3.0 software including Update 1 must also be installed.

Floating license, software, documentation and license key for download ¹⁾

Email address required for delivery

6ES7823-1TE06-0AA5

Software Update Service ²⁾

Upgrades and Service Packs for download ¹⁾

Email address required for delivery

6ES7823-1TE00-0AL5

¹⁾ For up-to-date information and download availability, see: <http://www.siemens.com/tia-online-software-delivery>

²⁾ For more information on the Software Update Service, see catalog ST 70 · 2019, page 11/2.

Overview

The TIA Portal option ProDiag makes it possible to monitor a machine or plant and to intervene in the event of a fault. The supervision messages which can be generated for the various faults provide specific information on the supervision mode, location and cause of the fault. Information on troubleshooting can be provided in addition. Plant operators can then not only recognize faults, they can also identify any potential danger in advance and take appropriate countermeasures.

Licensing

- The runtime license for controllers includes 250 supervisions or an unlimited number of supervisions per CPU. From FW 2.0 onwards, the software can run on S7-1500/ET 200SP CPUs regardless of the TIA Portal version.
- For the visualization of the messages, the controls are licensed according to the HMI runtime platforms.

You can find more information on the Software Update Service, license types, online software delivery and handling your SW licenses with the Automation License Manager here:

<http://www.siemens.com/simatic-licenses>

Technical specifications**Can be used for**

SIMATIC ProDiag S7-1500

For all S7-1500 CPUs and ET 200SP CPUs with FW V2.0 and higher

Ordering data**Article No.****SIMATIC ProDiag S7-1500 for 250 supervision functions**

For SIMATIC S7-1500 CPUs and ET 200SP CPUs with FW 2.0 and higher. Independent of the TIA Portal version.

Package with data storage medium

6ES7823-0AA00-1AA0

Download incl. license key ¹⁾

6ES7823-0AE00-1AA0

Email address required for delivery

SIMATIC ProDiag S7-1500 for all planned supervision tasks on a CPU

For SIMATIC S7-1500 CPUs and ET 200SP CPUs with FW 2.0 and higher. Independent of the TIA Portal version.

Package with data storage medium

6ES7823-0AA00-1DA0

Download incl. license key ¹⁾

6ES7823-0AE00-1DA0

Email address required for delivery

SIMATIC ProDiag for SIMATIC Comfort / Mobile Panels

Controls for SIMATIC WinCC as of V14.

Package with data storage medium

6AV2107-0UP00-0BB0

Download incl. license key ¹⁾

6AV2107-0UP00-0BH0

Email address required for delivery

SIMATIC ProDiag for WinCC Runtime Advanced

Controls for SIMATIC WinCC as of V14.

Package with data storage medium

6AV2107-0UA00-0BB0

Download incl. license key ¹⁾

6AV2107-0UA00-0BH0

Email address required for delivery

SIMATIC ProDiag for WinCC Runtime Professional

Controls for SIMATIC WinCC as of V14

Package with data storage medium

6AV2107-0UB00-0BB0

Download incl. license key ¹⁾

6AV2107-0UB00-0BH0

Email address required for delivery

¹⁾ For up-to-date information and download availability, see: <http://www.siemens.com/tia-online-software-delivery>

Software for SIMATIC Controllers

STEP 7 V5.x

Basic software and editors

STEP 7 Professional

Overview



STEP 7 Professional supports all IEC languages.

In addition to the languages familiar from STEP 7:

- LAD
- FBD
- STL,

the following are also available:

- Sequential function chart
- Structured text

An offline simulation of user programs created with these languages is included. STEP 7 Professional thus replaces the combination of the individual packages STEP 7, S7-GRAPH, S7-SCL and S7-PLCSIM.

A Powerpack (conversion package) is available for customers who use STEP 7 already and wish to change. A valid STEP 7 license is required for purchasing the POWERPACK. A separate update service can be purchased for STEP 7 Professional.

Note

The STEP 7 (TIA Portal) engineering software is required to program the new generation of S7-1200, S7-1500 and ET 200SP CPU controllers as well as the S7-1500 Software Controller; it can also be used for programming the S7-300, S7-400 and SIMATIC WinAC.

Siemens offers a combo license for both platforms which enables you to work using both STEP 7 (TIA Portal) as well as traditional engineering software. See "Licensing" for more information.

Licensing

- New installations of STEP 7 Professional 2017 are only available as combo licenses together with STEP 7 Professional V16 (TIA Portal). The software can be installed on multiple computers. The number of existing licenses determines the number of computers on which the software can be used simultaneously (floating license).
- A 50 h rental license is available for limited use.
- An upgrade to V16/2017 Combo is available for users of the previous STEP 7 Professional 2006...2010 versions.
- Powerpack and upgrade enable migration from STEP 7 V5.6 to STEP 7 Professional V16/2017 Combo.
- A trial license is available for testing purposes.
- It is possible to conclude Software Update Service (SUS) contracts.

You can find more information on the Software Update Service, license types, online software delivery and handling your SW licenses with the Automation License Manager here:

<http://www.siemens.com/simatic-licenses>

Technical specifications

Article number	6GK1571-0BA00-0AA0
Product type designation	PC adapter USB A2
Transfer rate	
Transfer rate	
• at the 1st interface acc. to PROFIBUS	9.6 kbit/s ... 12 Mbit/s
Interfaces	
Number of electrical connections	
• at the 1st interface acc. to PROFIBUS	1
Number of interfaces acc. to USB	1
Type of electrical connection	
• at the 1st interface acc. to PROFIBUS	9-pin Sub-D socket (RS 485)
• of the USB interface	Standard-B socket
Standard for interfaces USB 2.0	Yes

Article number	6GK1571-0BA00-0AA0
Product type designation	PC adapter USB A2
Supply voltage, current consumption, power loss	
Type of voltage of the supply voltage	DC
Type of voltage supply optional external supply	No
Supply voltage	
• from USB	5 V
• Note	Supply direct from USB
Relative symmetrical tolerance at DC	
• at 5 V	5 %
Consumed current	
• from USB	0.2 A
Power loss [W]	1 W
Ambient conditions	
Ambient temperature	
• during operation	0 ... 60 °C
• during storage	-40 ... +70 °C
• during transport	-40 ... +70 °C
Relative humidity at 30 °C during operation maximum	95 %
Protection class IP	IP20

Technical specifications

Article number	6GK1571-0BA00-0AA0
Product type designation	PC adapter USB A2
Design, dimensions and weight	
Module format	USB V2.0 adapter
Width	58 mm
Height	26 mm
Depth	105 mm
Net weight	365 g
Mounting type 35 mm DIN rail mounting	No
Product features, product functions, product components general	
Number of plug-in cards of same design plug-in per PC station	1
Number of units Note	-

Article number	6GK1571-0BA00-0AA0
Product type designation	PC adapter USB A2
Performance data	
Product functions Diagnostics	
Product function	
• Port diagnostics	Yes
Standards, specifications, approvals	
Standard	
• for EMC	2004/108/EC
• for safety from CSA and UL	cULus, UL 60950-1, CSA22.2
• for emitted interference	EN 61000-6-3, EN 61000-6-4
• for interference immunity	EN 61000-6-1, EN 61000-6-2
Certificate of suitability	
• CE marking	Yes
• C-Tick	Yes

Ordering data

	Article No.
STEP 7 Professional V16/2017 SR2 <i>Target system:</i> SIMATIC S7-300/400, SIMATIC C7, SIMATIC WinAC <i>Requirement:</i> Windows Server 2008 R2 SP1, Windows Server 2012 R2, Windows Server 2016/2019, Windows 7 SP1, Windows 10 Professional, Windows 10 Enterprise <i>Type of delivery:</i> English, German, French, Spanish, Italian; license key on USB flash drive, with electronic documentation	
Floating combo license on DVD	6ES7810-5CC13-0YA5
Floating license, license key download¹⁾ without software and documentation; email address required for delivery	6ES7810-5CE13-0YB5
Rental license for 50 hours, license key download¹⁾ without software and documentation; email address required for delivery	6ES7823-1GE06-0YA5

	Article No.
Conversion package STEP 7 Professional V16 Only valid if ordered together with Software Update Service 6ES7 810-5CC04-0YE2 (STEP 7 Professional and STEP 7 Professional in TIA Portal). • Powerpack & upgrade from STEP 7 V5.6 to STEP 7 Professional V16/2017 SR2 Combo, floating license. STEP 7 Software Update Service is a requirement. • Powerpack & upgrade from STEP 7 V5.6 to STEP 7 Professional V16/2017 SR2 Combo, floating license. STEP 7 Software Update Service is a requirement. Software download including license key ¹⁾ Email address required for delivery	6ES7822-1AA06-0XC2 6ES7822-1AE06-0XC2
Upgrade STEP 7 Professional V11...15 to STEP 7 Professional V16 or STEP 7 Professional V11...V15/201x Combo to V16/2017 SR2 Combo or STEP 7 Professional 2006...2010 to V16/2017 SR2 Combo, floating license	6ES7822-1AA06-0YE5
Upgrade STEP 7 Professional V11...15 to STEP 7 Professional V16 or STEP 7 Professional V11...V15/201x Combo to V16/2017 SR2 Combo or STEP 7 Professional 2006...2010 to V16/2017 SR2 Combo, floating license software download incl. license key¹⁾ Email address required for delivery	6ES7822-1AE06-0YE5

¹⁾ For up-to-date information and download availability, see: <http://www.siemens.com/tia-online-software-delivery>

Software for SIMATIC Controllers

STEP 7 V5.x

Basic software and editors

STEP 7 Professional

Ordering data

Article No.

Powerpack and upgrade from STEP 7 V5.4...V5.6 to STEP 7 Professional V16/2017 SR2 Combo, floating license

6ES7822-1AA06-0XC5

Trial License STEP 7 Professional 2017 SR2; on DVD, runs for 21 days

6ES7810-5CC12-0YA7

Software Update Service

For a period of 12 months and for a fixed price, the customer is automatically provided with all upgrades and Service Packs for each installed software package. The contract is automatically extended by a further year unless canceled at least 12 weeks prior to expiration. Requires the current software version

Software Update Service (Standard Edition)¹⁾

The delivery is implemented according to the number of ordered SUS products (e.g. 10 upgrade packages with 10 DVDs, 10 USB flash drives, etc.)

- STEP 7 Professional and STEP 7 Professional in the TIA Portal

6ES7810-5CC04-0YE2

Software Update Service (Compact Edition)¹⁾

The delivery items are combined. In future, only 1 package with 1 data storage medium set, 1 USB flash drive with the corresponding number of licenses and the corresponding number of COLs will be supplied for multiple contracts.

Delivery items to be combined must be ordered as one item.

- STEP 7 Professional and STEP 7 Professional in the TIA Portal

6ES7810-5CC00-0YM2

Article No.

Software Update Service (download)¹⁾²⁾

The upgrades and Service Packs are available for downloading.

Email address required for delivery

- STEP 7 Professional and STEP 7 Professional in the TIA Portal

6ES7810-5CC04-0YY2

EPROM programming device, USB Prommer

For programming SIMATIC Memory Cards and EPROM modules

6ES7792-0AA00-0XA0

MPI cable

For linking SIMATIC S7 and PG through MPI (5 m)

6ES7901-0BF00-0AA0

Components for connecting a PC to MPI and PROFIBUS

For PCs with a free PCI slot:

CP 5612

6GK1561-2AA00

For PCs without a free PCI slot:

USB A2 PC adapter

6GK1571-0BA00-0AA0

for connecting a PG/PC or Notebook to PROFIBUS or MPI; USB cable included in scope of supply

Components for connecting the PC to Industrial Ethernet

For PCs with a free PCI slot:

Layer 2 Ethernet cards

¹⁾ For more information on the Software Update Service, see catalog ST 70 · 2019, page 11/2.

²⁾ For up-to-date information and download availability, see: <http://www.siemens.com/tia-online-software-delivery>

Overview

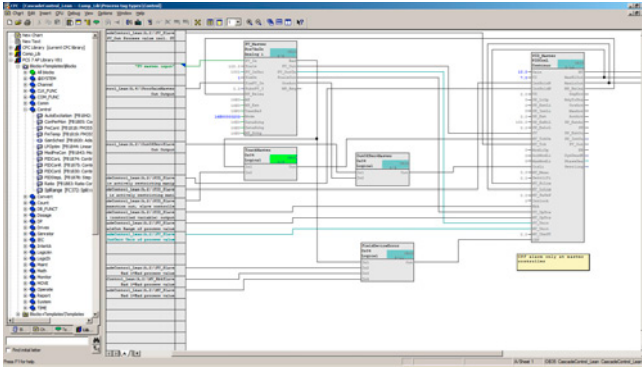

- For the generation of automation programs by drawing a technology chart
- With extensive libraries of ready-made software blocks to which user-created blocks can be added
- Minimized outlay and reduced error susceptibility due to the interconnection of ready-made blocks
- Optimized integration in the world of automation, for example, through guaranteed compatibility with all STEP 7 tools
- Can be used for SIMATIC S7-300 (recommended for CPU 316 or CPU 314C or higher), SIMATIC S7-400, SIMATIC WinAC and D7-SYS

Licensing

- SIMATIC CFC V9.0 is supplied with a floating license. The floating license allows installation of the software on any number of computers. This means one user per license can use the software independently of the computer used or from a specific workstation. The number of existing licenses determines the number of computers on which the software can be used simultaneously.
- An upgrade to version 9.0 is available for users of the previous 8.x versions.
- For SIMATIC CFC, the Software Update Service is available with the Standard, Compact and Download types of delivery.

You can find more information on the Software Update Service, license types, online software delivery and handling your SW licenses with the Automation License Manager:

<http://www.siemens.com/simatic-licenses>

Technical specifications

EngineeringTool	CFC
Current version	V9.0
Software class	A
Application areas	
Can be used for	Graphical creation, interconnection and parameterization of (preconfigured) blocks and functions
Marketing message	Simply interconnect and configure instead of programming!
Advantages	<ul style="list-style-type: none"> • Can be used to optimum effect even during the design phase • Reduced configuration effort thanks to graphical interconnection • High degree of reusability of diagrams that have already been created • Quick and easy familiarization • Quick and transparent interconnection of ready-made functions • Technological creation of the program as a whole • Clear representation of control loop structures • Short commissioning time • High plant availability • Less time required for engineering compared to LAD/FBD/STL: up to 50%
Sectors	<ul style="list-style-type: none"> • Automotive industry (e.g. thermostats, tire production processes) • Chemicals • Power engineering and supply • Rubber and plastics machines • Metalworking machines • Food and beverage machines • Petrochemicals • Rolling mills • Water industry • Coilers
Target systems	
Can be used in	S7-300 S7-400 F/H systems WinAC
System prerequisites	
Operating system	MS Windows 7 Professional with SP1 (64-bit) MS Windows 7 Ultimate with SP1 (64-bit) MS Windows 7 Enterprise with SP1 (64-bit) MS Windows 10 Pro (64-bit) MS Windows 10 Enterprise 2015 LTSB (64-bit) MS Windows Server 2008 R2 Standard Edition with SP1 (64-bit) MS Windows Server 2012 R2 Update Standard Edition (64-bit)
Required hard drive memory in the PG/PC	approx. 80 MB
Required software	STEP 7 V5.6 or higher

Software for SIMATIC Controllers

STEP 7 V5.x

Options for programming and design

CFC

Technical specifications

Properties	
Monitoring tags	Yes
Controlling tags	Yes
Single-step processing	-
Integration in CFC	Yes
Program runtimes	
with S7-300 (typical)	Depending on the interconnected blocks
with S7-400 (typical)	Depending on the interconnected blocks
Diagnostics	
Integration of diagnostic data in ProAgent	-
Integration of diagnostic data in ProTool/Pro	-
Integration of diagnostic data in WinCC	-
Supported standards	
IEC 61131-3	based on the IEC standard
Status of PLCopen activities	-
Available versions/licenses	
Floating license	<ul style="list-style-type: none"> • 1 CD • 1 license key memory stick • 1 Certificate of License
Upgrade (floating license)	<ul style="list-style-type: none"> • 1 CD • 1 license key memory stick • 1 Certificate of License
Software Update Service (SUS)	
Also a component part of	
STEP 7 Professional	-
S7 Trainer Package	-
PCS 7	Yes
D7-SYS	Yes

Ordering data

SIMATIC CFC, Version 9.0

Task: Graphic configuring and programming of automation applications in the form of technology-oriented diagrams

Target system:

SIMATIC S7-300/400,
SIMATIC WinAC, D7-SYS

Requirements:

STEP 7 V5.6 or higher

Type of delivery:

Engineering software and electronic documentation on CD-ROM, license key on USB flash drive, Certificate of License

Floating license

6ES7658-1EX58-0YA5

Floating License for download.

6ES7658-1EX58-0YH5

Email address required for delivery²⁾

Floating license upgrade from V8.x to V9.0

6ES7658-1EX58-0YE5

Floating License Upgrade from V8.x to V9.0 for download.

6ES7658-1EX58-0YK5

Email address required for delivery²⁾

Software Update Service (requires current software version)¹⁾

6ES7658-1EX00-2YL8

Software Update Service for multiple orders (requires current software version); the delivery items are combined.

6ES7658-1EX00-2YM8

For multiple contracts, only 1 package (1 data medium set and the corresponding number of licenses) will be supplied. Can be ordered with 5 or more contracts¹⁾

The delivery items to be combined must be ordered as one item.

Software Update Service (requires current software version)¹⁾

6ES7658-1EX00-2YV8

Email address required for delivery

SIMATIC Manual Collection

6ES7998-8XC01-8YE0

Electronic manuals on DVD, multilingual:
LOGO!, SIMADYN, SIMATIC bus components, SIMATIC C7, SIMATIC distributed I/O, SIMATIC HMI, SIMATIC sensors, SIMATIC NET, SIMATIC PC-Based Automation, SIMATIC PCS 7, SIMATIC PG/PC, SIMATIC S7, SIMATIC software, SIMATIC TDC

SIMATIC Manual Collection update service for 1 year

6ES7998-8XC01-8YE2

Current "Manual Collection" DVD and the three subsequent updates

¹⁾ For more information on the Software Update Service, see catalog ST 70 · 2019, page 11/2.

²⁾ For up-to-date information and download availability, see: <http://www.siemens.com/tia-online-software-delivery>

Overview

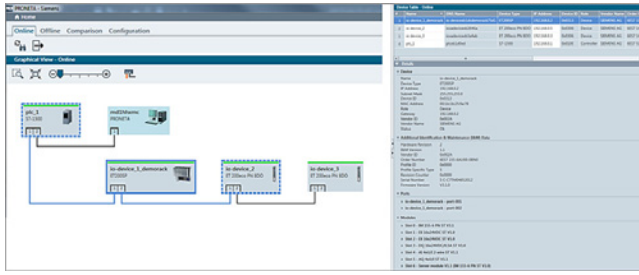

PRONETA Professional Topology View

Asset Management with PRONETA Professional

With PRONETA Professional, the network can be scanned automatically in regular intervals and the real plant configuration can thereby be documented transparently. This allows for new opportunities and for better planning of maintenance and servicing which, in turn, optimizes plant operation. This prevents undesired situations, such as a missing, compatible spare part, during maintenance and service. This increases production availability.

Licenses

- The software can be installed on one computer (single license).

You can find more information on the Software Update Service, license types, online software delivery and handling your SW licenses with the Automation License Manager here:

<https://www.siemens.com/simatic-licenses>

Technical specifications

PRONETA Professional V1.0 can be used on the following operating systems:

- Microsoft Windows 7 (32-bit and 64-bit)
 - Microsoft Windows 7 Professional SP1
 - Microsoft Windows 7 Enterprise SP1
 - Microsoft Windows 7 Ultimate SP1
- Microsoft Windows 10 (64-bit):
 - Microsoft Windows 10 Home version 1809
 - Microsoft Windows 10 Pro version 1809
 - Microsoft Windows 10 Enterprise version 1809

Ordering data

Article No.

PRONETA Professional V1.0

API software for connecting PRONETA with an MQTT broker; 2 languages de/en, executable under Windows 7 (32-bit and 64-bit) and Windows 10 (64-bit)

Single license; software, documentation and license for download

6ES7853-2BE00-0YA5

Software for SIMATIC Controllers

Notes

12

SIMATIC programming devices



13/2
13/2

Programming devices
Field PG M6

SIMATIC programming devices

Programming devices

Field PG M6

Overview



- The mobile, industry-standard programming device for automation engineers with a powerful, eighth-generation Intel® Core™ i processor (Coffee Lake) and high-speed RAM (DDR4 RAM)
- Elegant, robust enclosure made of light-weight stable injection-molded magnesium with rubber-protected corners and retractable carry-handle
- Can optimally be used both for engineering in the office and for the commissioning, service or maintenance of automation systems
- Industrial notebook with all commonly used interfaces for industrial applications
- Can be used immediately thanks to pre-installed SIMATIC engineering software

Technical specifications

Article number	6ES7718-.....-.... SIMATIC Field PG M6
General information	
Design of the programming device	Notebook
Display	
Design of display	15.6" full HD display in 16:9 format
Resolution (pixels)	
• Horizontal image resolution	1 920 Pixel
• Vertical image resolution	1 080 Pixel
General features	
• Non-reflecting	Yes
• Luminance	300 cd/m ²
Backlighting	
• Type of backlighting	LED
Control elements	
Keyboard fonts	
• Design	QWERTZ/QWERTY or AZERTY (French); 87 keys
Touch operation	
• Integrated touch pad	Yes; Clickpad
Supply voltage	
Design of the power supply	External wide-range power supply; 3-pole
permissible range, lower limit (AC)	100 V; ±10 %, sinusoidal
permissible range, upper limit (AC)	240 V; ±10 %, sinusoidal
Line frequency	
• permissible range, lower limit	47 Hz
• permissible range, upper limit	63 Hz
Processor	
Processor type	Intel Core i5-8400H (2.5 to 4.2 GHz, 4 cores and hyper-threading, 8 MB Smart Cache) or i7-8850H (2.6 to 4.3 GHz 6 cores and hyper-threading, 9 MB Smart Cache)
Chipset	Intel CM246
Hyper-threading	Yes
Turbo Boost Technology 2.0	Yes
Graphic	
Graphics controller	Intel® UHD Graphics 630
Drives	
DVD-RW	Yes
SSD	Yes; Easy to replace
• Memory capacity	256 Gbyte
TPM Security Chip	Yes; 2.0 (version for China without TPM)
Memory	
Work memory	
• Number of slots	2
Accumulator	
Replaceable	Yes; Lithium-ion battery
Capacity	8.25 A·h

Technical specifications

Article number	6ES7718-.....-.... SIMATIC Field PG M6
Interfaces	
Number of interfaces PROFIBUS DP	1
Number of RS 232 interfaces	1; 25-pin socket
Number of USB interfaces	4
• Type A	3; 1x USB port incl. integrated charging function for USB devices (e.g. smartphone) - also with device switched off
• Type C	1; USB 3.1 Gen. 2
Number of chip-card readers	1; Smart Card Reader (ISO/IEC 7816)
Bluetooth radio standard	Yes; V5.0
Multimedia card/SD card slot	2 in 1 (SDHC UHS-II, MMC)
Card reader for SIMATIC memory cards	SIMATIC memory cards (for S7-300/400), SMC (for S7-1x00), SIMATIC micro memory card (for S7-300/C7/ET 200) - including programming interfaces
Universal Audio Jack	Yes; Audio socket for 3.5 mm jack
Video interfaces	
• analog video signal (VGA)	Yes; via adapter from DVI to VGA
• DVI-I	Yes; 1x
• DisplayPort	Yes; 1x
Industrial Ethernet	
• Industrial Ethernet interface	2x Ethernet (RJ45)
- 100 Mbps	Yes
- 1000 Mbps	Yes; Gigabit Ethernet; 2x RJ45 with 2 independent MAC/IP addresses
• Wake on LAN	Yes
• IAMT (Intel Active Management Technology)	Yes
WLAN	
• Type	802.11ac
EMC	
Interference immunity against discharge of static electricity	
• Interference immunity against discharge of static electricity acc. to IEC 61000-4-2	Yes; ± 4 kV contact discharge acc. to IEC 61000-4-2, ESD; ± 8 kV air discharge acc. to IEC 61000-4-2, ESD
Interference immunity to cable-borne interference	
• Interference immunity on supply cables	± 2 kV (according to IEC 61000-4-4, burst); ± 1 kV (according to IEC 61000-4-5, surge pulse/line to line); ± 2 kV (according to IEC 61000-4-5, surge pulse/line to ground)
• Interference immunity on signal cables	± 1 kV (according to IEC 61000-4-4, burst, length < 30 m); ± 2 kV (according to IEC 61000-4-4, burst, length > 30 m); ± 2 kV (according to IEC 61000-4-5, surge sym./line to ground, length > 30 m)

Article number	6ES7718-.....-.... SIMATIC Field PG M6
Standards, approvals, certificates	
CE mark	Yes
CSA approval	Yes
UL approval	Yes
DIN/ISO 9001	Yes
Ambient conditions	
Ambient temperature during operation	
• min.	5 °C; Max. 10 °C/h (no condensation)
• max.	40 °C; Max. 10 °C/h (no condensation)
Operating systems	
pre-installed operating system	
• Windows 10	Yes; Windows 10 Enterprise 64-bit
Software	
Preinstalled	
• STEP 7 Professional (TIA Portal)	Yes
• STEP 7	Yes
• WinCC flexible Advanced 2008	Yes; Software version: SP5
• WinCC Advanced (TIA Portal)	Yes
• STEP 5	Yes; Optional; software version: STEP 5 V7.23 HF2 (incl. GRAPH 5/II V7.15)
Mechanics/material	
Material of housing	metal
Handle	Yes; retractable
Socket for Kensington lock	Yes
rubber corner guards	Yes
Dimensions	
Width	385 mm
Height	53 mm
Depth	275 mm
Weights	
Weight, approx.	3.4 kg; incl. rechargeable battery
Scope of supply	
Accumulator	Yes
Power supply	Yes
Backpack	Yes
SIMATIC Software	Yes
Recovery media	Yes; Restore & Recovery

SIMATIC programming devices

Programming devices

Field PG M6

Ordering data

Field PG M6 Comfort programming device	Article No.
Intel i5-8400H processor (8 MB Smart Cache, 2.5 to 4.2 GHz, 4 cores + Hyper-Threading), 15.6" display, full HD (1920x1080), DVD+-RW drive, UHD graphics 630, WLAN 802.11ac, Bluetooth v5.0; without SIMATIC S5 interface, without SIMATIC S5 EPROMMER	6ES7718- 0 0 0 - 1
RAM	
• 1 x 8 GB DDR4 SDRAM SO-DIMM	A
• 1 x 16 GB DDR4 SDRAM SO-DIMM	B
• 1 x 32 GB DDR4 SDRAM SO-DIMM	C
• 2 x 32 GB DDR4 SDRAM SO-DIMM	D
Hard disk	
• 256 GB SSD SATA (2.5")	A
• 512 GB SSD SATA (2.5")	B
• 2 TB SSD SATA (2.5")	C
Keyboard and power cable (essential)	
• Keyboard: QWERTY (& German); power supply cable: Germany, France, the Netherlands, Spain, Belgium, Austria, Sweden, Finland	0
• Keyboard: AZERTY (France); power supply cable: Germany, France, the Netherlands, Spain, Belgium, Austria, Sweden, Finland	1
• Keyboard: QWERTY (& German); power supply cable: Italy	2
• Keyboard: QWERTY (& German); power supply cable: Switzerland	3
• Keyboard: QWERTY (& German); power supply cable: USA	4
• Keyboard: QWERTY (& German); power supply cable: United Kingdom	5
• Keyboard: QWERTY (& German); power supply cable: China; approval for China (CCC)	6
• Keyboard: QWERTY (& German); without power supply cable	7
M.2 NVME hard drive	
• Without M.2 hard drive	0
• 512 GB SSD NVME (M.2)	1
• 1 TB SSD NVME M.2	2
Operating system	
• Windows 10 Enterprise, 64-bit	A
• Windows 10 Enterprise LTSC 2019, 64-bit	B
• Without operating system	N

Article No.

Field PG M6 Comfort programming device	Article No.
SIMATIC software licenses	6ES7718- 0 0 0 - 1
• Trial license: STEP 7 Professional Combo (STEP 7 Prof. V16 and STEP 7 Prof. 2017 SR1), WinCC Advanced Combo (WinCC V16 and WinCC flexible 2008 SP5), Safety Advanced Combo (Safety Adv. V16 and Distributed Safety V5.4 SP5)	A
• License: STEP 7 & WinCC & Safety in the TIA Portal: STEP 7 Prof. V16, WinCC Adv. V16, Safety Advanced V16	B
• License: STEP 7 & WinCC & Safety Combo: STEP 7 Professional Combo (STEP 7 Prof. V16 and STEP 7 Prof. 2017 SR1), WinCC Advanced Combo (WinCC V16 and WinCC flexible 2008 SP5), Safety Advanced Combo (Safety Adv. V16 and Distributed Safety V5.4 SP5)	C

Ordering data	Article No.	Article No.	
<p>Field PG M6 Advanced programming device</p> <p>Intel i7-8850H processor (9 MB Smart Cache, 2.6 to 4.3 GHz, 6 cores + Hyper-Threading), 15.6" display, full HD (1920x1080), DVD+-RW drive, UHD graphics 630, WLAN 802.11ac, Bluetooth v5.0;</p> <p>RAM</p> <ul style="list-style-type: none"> • 1 x 8 GB DDR4 SDRAM SO-DIMM • 1 x 16 GB DDR4 SDRAM SO-DIMM • 1 x 32 GB DDR4 SDRAM SO-DIMM • 2 x 32 GB DDR4 SDRAM SO-DIMM <p>Hard disk</p> <ul style="list-style-type: none"> • 256 GB HDD SATA • 512 GB SSD SATA • 2 TB SSD SATA <p>SIMATIC S5 interface</p> <ul style="list-style-type: none"> • Without S5 interface, without S5 EPROMMER • With S5 interface, with S5 EPROMMER; incl. STEP 5 license, S5 PLC cable and EPROM adapter <p>Keyboard and power cable (essential)</p> <ul style="list-style-type: none"> • Keyboard: QWERTY (& German); power supply cable: Germany, France, the Netherlands, Spain, Belgium, Austria, Sweden, Finland • Keyboard: AZERTY (France); power supply cable: Germany, France, the Netherlands, Spain, Belgium, Austria, Sweden, Finland • Keyboard: QWERTY (& German); power supply cable: Italy • Keyboard: QWERTY (& German); power supply cable: Switzerland • Keyboard: QWERTY (& German); power supply cable: USA • Keyboard: QWERTY (& German); power supply cable: United Kingdom • Keyboard: QWERTY (& German); power supply cable: China; approval for China (CCC) • Keyboard: QWERTY (& German); without power supply cable 	<p>6ES7718- 1 - 1</p> <p>A B C D</p> <p>0 1</p> <p>0 1 2 3 4 5 6 7</p>	<p>Field PG M6 Advanced programming device</p> <p>M.2 NVME hard drive</p> <ul style="list-style-type: none"> • Without M.2 hard drive • 512 GB SSD NVME (M.2) • 1 TB SSD NVME M.2 <p>Operating system</p> <ul style="list-style-type: none"> • Windows 10 Enterprise, 64-bit • Windows 10 Enterprise LTSC 2019, 64-bit • Without operating system <p>SIMATIC software licenses</p> <ul style="list-style-type: none"> • Trial license: STEP 7 Professional Combo (STEP 7 Prof. V16 and STEP 7 Prof. 2017 SR1), WinCC Advanced Combo (WinCC V16 and WinCC flexible 2008 SP5), Safety Advanced Combo (Safety Adv. V16 and Distributed Safety V5.4 SP5) • License: <u>STEP 7 & WinCC & Safety in the TIA Portal:</u> STEP 7 Prof. V16, WinCC Adv. V16, Safety Advanced V16 • License: <u>STEP 7 & WinCC & Safety Combo:</u> STEP 7 Professional Combo (STEP 7 Prof. V16 and STEP 7 Prof. 2017 SR1), WinCC Advanced Combo (WinCC V16 and WinCC flexible 2008 SP5), Safety Advanced Combo (Safety Adv. V16 and Distributed Safety V5.4 SP5) 	<p>6ES7718- 1 - 1</p> <p>0 1 2</p> <p>A B N</p> <p>A B C</p>

SIMATIC programming devices

Programming devices

Field PG M6

Ordering data	Article No.	Article No.
Accessories		
Memory expansion		
8 GB RAM	6ES7648-3AK00-0PA0	
16 GB RAM	6ES7648-3AK10-0PA0	
AC/DC external power supply unit	6ES7798-0GA05-0XA0	
For Field PG M6 only; spare part, included in the scope of supply of the Field PG M6		
Power cable (length 3 m)		
For Field PG M2/M4/M5/M6 only		
For Germany, France, the Netherlands, Spain, Belgium, Austria, Sweden, Finland	6ES7900-5AA00-0XA0	
For Great Britain	6ES7900-5BA00-0XA0	
For Switzerland	6ES7900-5CA00-0XA0	
For USA	6ES7900-5DA00-0XA0	
For Italy	6ES7900-5EA00-0XA0	
For China	6ES7900-5FA00-0XA0	
Spare battery (lithium ion, 8.25 Ah)¹⁾	6ES7798-0AA10-0XA0	
For Field PG M6 only; spare part, included in the scope of supply of the Field PG M6		
MPI cable	6ES7901-0BF00-0AA0	
For connecting a PG and SIMATIC S7 via MPI; 5 m		
S5 EPROM programming adapter	6ES7798-0CA00-0XA0	
For SIMATIC S5 EPROM programming using the Field PG		
S5 connection cable	6ES5734-2BF00	
For connecting programming devices to SIMATIC S5 PLCs, 5 m		
Replaceable SSD kit		
Replaceable SSD 512 GB serial ATA; with protective pocket and torx screwdriver; for Field PG M5/M6	6ES7791-2BA22-0AA0	
Replaceable SSD 2 TB serial ATA; with protective pocket and torx screwdriver; for Field PG M6	6ES7791-2BA25-0AA0	
Adapter serial ATA to USB 3.0	6ES7790-1AA01-0AA0	
For using the removable hard disk in the hard disk kit as an external hard disk (only for Field PG M4/M5/M6)		
		Rucksack for Field PG M4/M5/M6
		6ES7798-0DA02-0XA0
		SIMATIC IPC Image & Partition Creator V3.5
		6ES7648-6AA13-5YA0
		Software tool for very easy preventive data backup and efficient partition management on SIMATIC IPCs
		SIMATIC IPC Remote Manager V1.3
		6ES7648-6EA01-3YA0
		Software tool for efficient remote maintenance and management of a SIMATIC IPC
		Software Update Service (Standard Edition)²⁾
		The delivery is implemented according to the number of ordered SUS products (e.g. 10 upgrade packages with 10 DVDs, 10 USB flash drives, etc.)
		• STEP 7 Professional V1x
		• STEP 7 Professional Combo (STEP 7 Prof. V1x (TIA Portal) and STEP 7 Prof.)
		• SIMATIC WinCC Advanced
		• SIMATIC STEP 7 Safety Advanced
		Software Update Service (download)²⁾
		The upgrades and service packs are available for downloading. Email address required for delivery
		• STEP 7 Professional V1x
		• STEP 7 Professional Combo (STEP 7 Prof. V1x (TIA Portal) and STEP 7 Prof.)
		• SIMATIC WinCC Advanced
		• SIMATIC STEP 7 Safety Advanced
		6ES7822-1AA00-0YL5
		6ES7810-5CC04-0YE2
		6AV6613-0AA00-0AL0
		6ES7833-1FC00-0YX2
		6ES7822-1AE00-0YY0
		6ES7810-5CC04-0YY2
		6AV6613-0AA00-0AY0
		6ES7833-1FC00-0YY0

¹⁾ The capacity of the battery decreases for technological reasons with each charging/discharging cycle and also as the result of being stored at excessively high or low temperatures. The running time per charge decreases therefore over the course of time. With normal use, the battery can be charged and discharged over a period of six months from when the Field PG is purchased. Loss of capacity is not covered by the warranty. For the battery's operation we grant a warranty of six months. We recommend replacing the battery with an original Siemens battery at the end of these six months if there is a significant drop in performance.

²⁾ For more information on the Software Update Service, see catalog ST 70 · 2019, page 11/2.

Products for specific requirements



- 14/2** **Automatic door controls**
- 14/2 Automatic door controls for elevators
- 14/2 Controllers
- 14/2 - SIDAOR AT40 elevator door drive
- 14/5 Automatic door controls for railway applications
- 14/5 Controllers
- 14/5 - Controllers for gap fillers

Products for specific requirements

Automatic door controls
for elevators

Controllers > SIDOOR AT40 elevator door drive

Overview

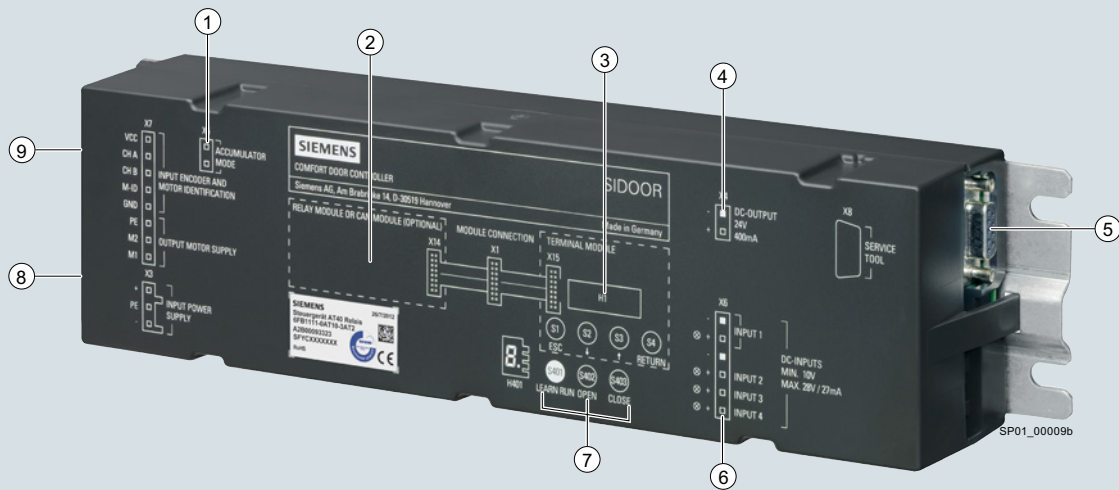

- | | |
|---|--|
| <ul style="list-style-type: none"> ① Optional: additional input signal ② BASIC, CAN or relay module version ③ Terminal module ④ Connection for 24 V DC/400 mA output voltage ⑤ Connection <ul style="list-style-type: none"> - Software Kit or - Service Tool | <ul style="list-style-type: none"> ⑥ Input signal connection ⑦ Control panel ⑧ Connector <ul style="list-style-type: none"> - NT40 switch-mode power supply or - Mains transformer ⑨ Motor connection |
|---|--|

SIDOOR AT40 elevator door drive (relay module version)

SIDOOR AT40 – SIDOOR enables the quick, easy and versatile installation, configuration and operation of a wide range of elevator door systems.

- Version:
- BASIC (without module)
- RELAY (including relay and terminal module)
- CAN (including CAN and terminal module), two controllers are available: SIDOOR AT40 CAN and CAN ADV.
 - Certified by CiA (CiA 301 / CiA 417).
 - The door system can be visualized and parameterized by the elevator controller using the "Virtual Terminal" function.
 - With the SIDOOR AT40 CAN ADV controller, parameters for evaluating mechanical wear can be provided at the door. These parameters can be accessed from the CAN-BUS via the elevator controller or other bus nodes and can be evaluated floor-dependently by an external evaluation logic. It includes, e.g. event counters, maximum current values in the slow end distance of the door, traversing times and energy values of the opening and closing cycles, as well as other performance values.
 - The evaluation can affect the maintenance cycles of the elevator system.
- For dynamic door weights up to 600 kg, depending on motor variant
- Automatic door weight detection
- 4 to 8 kg maximum counterweight (depending on motor version)
- Operating temperature -20 to +50 °C
- Flexible motor management (four different motor types), automatic detection
- Opening width 0.3 to 5 m
- Auxiliary power output 24 V DC ± 15 %; 0.4 A (short-circuit-proof)
- Output stage short-circuit-proof
- Supports power-optimized operation in the elevator cabin
- Vandal-proof
- IP54 degree of protection for 180 to 600 kg motor versions, gear unit IP40 (SIDOOR M5: entirely IP54)
- The current operating states are indicated via a 7-segment display directly in the elevator door drive or externally. The SIDOOR SOFTWARE KIT or the SIDOOR SERVICE TOOL is used for this, see Additional units.

Technical specifications

Article number	6FB1111-0AT11-3AT0 SIDOOR AT40 BASIC	6FB1111-0AT10-3AT2 SIDOOR AT40 RELAY	6FB1111-1AT10-3AT3 SIDOOR AT40 CAN	6FB1111-1AT11-3AT3 SIDOOR AT40 CAN ADV
General information				
Product type designation	AT40 BASIC	AT40 RELAY	AT40 CAN	AT40 CAN ADV
Product version		With relay outputs	With CAN interface	With CAN interface and maintenance data via CANopen
Manufacturer's article no. of the usable motor	6FB1103-0AT10-5MA0, 6FB1103-0AT11-5MA0, 6FB1103-0AT10-4MB0, 6FB1103-0AT11-4MB0, 6FB1103-0AT10-3MCO, 6FB1103-0AT11-3MCO, 6FB1103-0AT10-3MDO, 6FB1103-0AT11-3MDO			
Manufacturer's article no. of the usable power supply unit	6FB1112-0AT20-2TR0, 6FB1112-0AT20-3PS0			
Supply voltage				
Design of the power supply	via SIDOOR TRANSFORMER / NT40			
Input current				
Current consumption, max.	10 A			
I ² t, min.	30 A ² ·s			
Encoder supply				
Output voltage (DC)	24 V			
short-circuit proof	Yes			
Remark	Ensure correct polarity! CAUTION: Do not supply with external voltage!			
Output current				
• For output (24 V DC), max.	400 mA			
Power				
Active power input	80 W			
Active power input, max.	540 W			
Active power input (standby mode)	5 W		6 W	
Digital inputs				
Control inputs isolated	Yes			
Control inputs p-switching	Yes			
Input voltage				
• per DC input, min.	10 V; Observe polarity !			
• per DC input, max.	28 V; Observe polarity !			
Input current				
• per DC input, min.	9 mA			
• per DC input, max.	27 mA			
Digital outputs				
Relay outputs				
Switching capacity of contacts				
- at 30 V DC, min.			0.01 A	
- at 30 V DC, max.			1 A	
- at 50 V DC, min.			0.01 A; Switching voltage 50 V DC	
- at 50 V DC, max.			1 A; Switching voltage 50 V DC	
- at 230 V AC, min.			0.01 A	
- at 230 V AC, max.			1 A	
Mechanical data				
Opening width of door, min.	0.3 m			
Opening width of door, max.	5 m			
Weight of door, max.	600 kg			
Operating cycle frequency of door, max.	180 1/h			
Counterforce, max.	80 N			
Kinetic energy, max.	100 J			
Counterweight				
• with SIDOOR M2 geared motor, max.	4 kg			
• with SIDOOR M3 geared motor, max.	6 kg			
• with SIDOOR M4 geared motor, max.	8 kg			
• with SIDOOR M5 geared motor, max.	8 kg			

Products for specific requirements

Automatic door controls
for elevators

Controllers > SIDOOR AT40 elevator door drive

Technical specifications

Article number	6FB1111-0AT11-3AT0	6FB1111-0AT10-3AT2	6FB1111-1AT10-3AT3	6FB1111-1AT11-3AT3
	SIDOOR AT40 BASIC	SIDOOR AT40 RELAY	SIDOOR AT40 CAN	SIDOOR AT40 CAN ADV
Interfaces				
Interfaces/bus type	without		CANopen, CiA standard 301, profile 417	
Number of bus nodes	32			
Isolation				
Overvoltage category	2			
Degree and class of protection				
IP degree of protection	IP20			
Standards, approvals, certificates				
Certificate of suitability according to EN 81	Yes			
CE mark	Yes			
UL approval	No			
EAC (formerly Gost-R)	Yes			
TÜV Inspectorate approval	Yes			
TÜV prototype tested	Yes			
China RoHS compliance	Yes			
Standard for EMC	EN 12015 / EN 12016			
Standard for safety	EN 60950-1 / EN 81-20			
Ambient conditions				
Ambient temperature during operation				
• min.	-20 °C			
• max.	50 °C			
Ambient temperature during storage/transportation				
• Storage, min.	-40 °C			
• Storage, max.	50 °C			
Altitude during operation relating to sea level				
• Installation altitude above sea level, max.	2 000 m			
Relative humidity				
• No condensation, min.	10 %			
• No condensation, max.	93 %			
Dimensions				
Width	320 mm			
Height	60 mm			
Depth	80 mm			

Ordering data

Article No.

SIDOOR AT40 elevator door drive

- horizontal, up to 600 kg door weight

BASIC controller (without module)

6FB1111-0AT11-3AT0

RELAY controller (including relay and terminal module)

6FB1111-0AT10-3AT2

CAN controller (including CAN and terminal module),

6FB1111-1AT10-3AT3

Controller with CAN module and maintenance data via CANopen

6FB1111-1AT11-3AT3

Overview

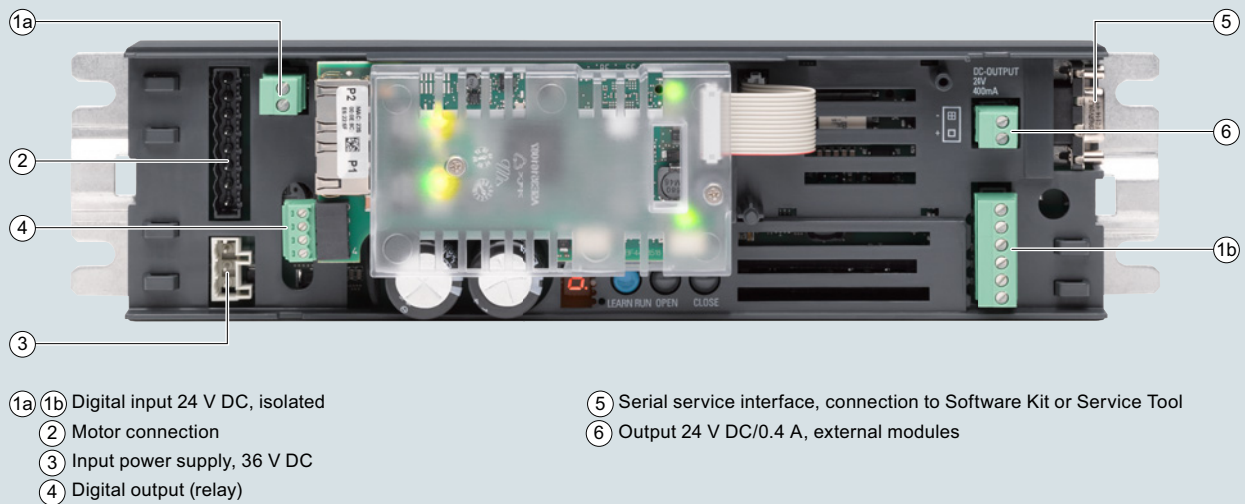

- ①a ①b Digital input 24 V DC, isolated
 ② Motor connection
 ③ Input power supply, 36 V DC
 ④ Digital output (relay)

- ⑤ Serial service interface, connection to Software Kit or Service Tool
 ⑥ Output 24 V DC/0.4 A, external modules

SIDOOR ATE530G

The SIDOOR ATE530G drive control is designed for controlling gap fillers between external train doors and the platform edge. The gap filler facilitates easy access for passengers. The innovative SIDOOR ATE530G drive solution enables operation of a gap filler with adjustable speed, acceleration and motor currents.

A project-specific motor is used depending on the application. The SIDOOR ATE530G controller is activated by digital signals from a higher-level door control, and reports information about its current state via digital signals back to the door control.

The following drive functions are supported:

- System start-up after power failure
- "Extend", "Retract" command
- Gap filler is moved by a travel curve profile
- Obstruction detection
- Ice-breaker function
Icing can be shifted broken by repeated extension and retraction of the gap filler with increased force.
- Reversing at the platform edge

The SIDOOR ATE530G controller fulfills Basic Integrity in accordance with EN 50657:2017

Technical specifications

Article number	6FB1221-5SM10-7BP0 SIDOOR ATE530G COATED
General information	
Product type designation	ATE530G COATED
Product version	ATE530G with protective coating
Mean time between failures (MTBF)	13 y
Installation type/mounting	
Installation and mounting instructions	No direct exposure to the sun
Supply voltage	
Design of the power supply	Via SIDOOR TRANSFORMER or via DC
Rated value (DC)	36 V
Protection in case of DC supply	Use of a miniature circuit breaker in the supply branch acc. to 60898-1, 8A, type C characteristic
Encoder supply	
Output voltage (DC)	24 V
short-circuit proof	Yes
Overload-proof	Yes
Remark	Ensure correct polarity! CAUTION: Do not supply with external voltage!

Article number	6FB1221-5SM10-7BP0 SIDOOR ATE530G COATED
Output current	
• For output (24 V DC), max.	400 mA
Power	
Active power input	80 W
Active power input, max.	540 W
Active power input (standby mode)	7 W
Digital inputs	
Control inputs isolated	Yes
Control inputs p-switching	Yes
Input voltage	
• per DC input, min.	10 V; Observe polarity !
• per DC input, max.	28 V; Observe polarity !
Input current	
• per DC input, min.	3 mA
• per DC input, max.	15 mA

Products for specific requirements

Automatic door controls
for railway applications

Controllers > Controllers for gap fillers

Technical specifications

Article number	6FB1221-5SM10-7BP0 SIDOOR ATE530G COATED
Digital outputs	
Relay outputs	
Switching capacity of contacts	
- at 30 V DC, min.	0.01 A
- at 30 V DC, max.	0.5 A
Isolation	
Overvoltage category	2
Degree and class of protection	
IP degree of protection	IP20
Standards, approvals, certificates	
CE mark	Yes
EAC (formerly Gost-R)	Yes
Standard for EMC	EN 61000-6-2 / EN 61000-6-4 / EN 61326-3-1 / EN 50121-3-2 / EN50121-4 / EN50121-5
Ambient conditions	
Ambient temperature during operation	
• min.	-25 °C
• max.	50 °C
• Remark	Screw control device thermally conductive onto a metallic mounting surface or standard rail mounting, otherwise the maximum operating temperature is only 40 °C
Ambient temperature during storage/transportation	
• Storage, min.	-40 °C
• Storage, max.	85 °C
Altitude during operation relating to sea level	
• Installation altitude above sea level, max.	2 000 m
Relative humidity	
• No condensation, min.	10 %
• No condensation, max.	93 %
Dimensions	
Width	320 mm
Height	60 mm
Depth	80 mm

Ordering data

SIDOOR ATE530G controller for gap fillers
SIDOOR ATE530G coated,
For controlling gap fillers
between external train doors and
the platform edge.

Article No.

6FB1221-5SM10-7BP0

Appendix



17/2	SITRAIN – Digital Industry Academy
17/3	Additional documentation
17/3	SIMATIC Manual Collection
17/4	Standards and approbations
17/4	CE marking
17/5	Certificates
17/5	Quality management
17/6	Siemens Automation Cooperates with Education (SCE)
17/6	Teaching made easy - Comprehensive support on the way to Industry 4.0
17/9	Partners
17/9	Siemens Partner Program
17/10	Partners at Siemens
17/11	Industry Services
17/12	Industry Services – Portfolio overview
17/13	Online Support
17/14	Software licenses
17/17	Conditions of sale and delivery

Appendix

SITRAIN – Digital Industry Academy

Introduction



Time for learning

Today's demands on our knowledge are every bit as diverse and dynamic as our profession itself. We keep learning more and longer – for our work, for our career and for ourselves. Advancing digitalization entails new topics and is also changing the way we absorb and process knowledge. SITRAIN – Digital Industry Academy offers the right source of knowledge here, which we can use anytime in just the way we need it. The time for learning is now.

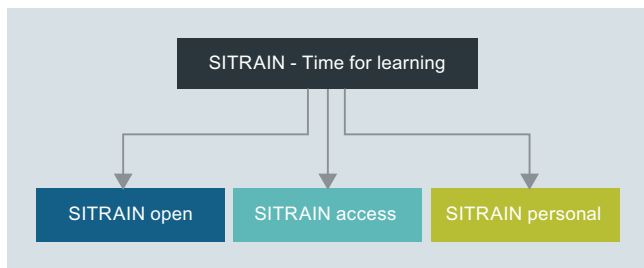

Knowledge for every need

With its three areas – SITRAIN open, SITRAIN access and SITRAIN personal – SITRAIN offers you an all-encompassing range of options for an ongoing expansion of your knowledge and skills, suited for every type of learner. And SITRAIN uses advancing digitalization to continuously expand content and offer new training methods.

Knowledge you can always find

SITRAIN open bundles useful information, worthwhile data and up-to-date expert knowledge about Siemens products for industry. Search it anytime, find anything – and always the right stuff.

Knowledge that gets you ahead

SITRAIN access is learning in the digital age. It offers you individualized ways to build your knowledge and access to exclusive digital training courses. Take advantage of sustainable learning success with a wide range of learning methods. Improve your skills – whether working in groups with others, or by yourself. Whenever, wherever and however you need to.

Knowledge you can experience

We all want to learn from the best. And SITRAIN personal's training courses let you benefit from our well-practiced trainers' expert knowledge, along with direct access to our training equipment. That's the best way to convey knowledge – whether at your company or in our training classrooms.

17

Find
your local
offer here



SITRAIN – Digital Industry Academy Customer Support Germany

Tel.: +49 911 895-7575

E-Mail: sitrain.digital.industry.academy.de@siemens.com

SITRAIN – Digital Industry Academy

siemens.com/sitrain

- SITRAIN open:
siemens.com/sitrain-open
- SITRAIN access:
siemens.com/sitrain-access
- SITRAIN personal:
siemens.com/sitrain-personal

Übersicht

The SIMATIC manual collection brings together the manuals of Totally Integrated Automation in the smallest possible package. It is eminently suitable for startup and service, replaces the space-consuming paper version in the office and provides fast access to the information.

The manual collection contains manuals in 5 languages for

- LOGO!
- SIMADYN
- SIMATIC bus components
- SIMATIC C7
- SIMATIC Distributed I/O
- SIMATIC HMI
- SIMATIC Sensors
- SIMATIC NET
- SIMATIC PC-based Automation
- SIMATIC PCS 7
- SIMATIC PG/PC
- SIMATIC S7
- SIMATIC Software
- SIMATIC TDC

Manuals that are not yet available in all 5 languages will at least be included in English and German.

There is an update contract for the SIMATIC Manual Collection that encompasses supply of the up-to-date collection and three subsequent updates which is valid for one year. If the update contract is not cancelled, it is automatically extended and the list price will be charged to the customer.

Ordering data

SIMATIC Manual Collection

Electronic manuals on DVD, multilingual:
 LOGO!, SIMADYN, SIMATIC bus components, SIMATIC C7, SIMATIC Distributed I/O, SIMATIC HMI, SIMATIC Sensors, SIMATIC NET, SIMATIC PC-based Automation, SIMATIC PCS 7, SIMATIC PG/PC, SIMATIC S7, SIMATIC Software, SIMATIC TDC

SIMATIC Manual Collection update service for 1 year

Current "Manual Collection" DVD and the three subsequent updates

Article No.

6ES7998-8XC01-8YE0

6ES7998-8XC01-8YE2

Appendix

Standards and approbations

CE marking

Overview

The electronic products described in this catalog comply with the requirements and protection objectives of the following EU directives insofar as they relate to the product concerned. They also comply with the corresponding harmonized European standards (EN) published for these products in the Official Journals of the European Community.

- 2014/30/EU "Electromagnetic Compatibility" (EMC Directive)
- 2014/35/EU "Electrical equipment designed for use within certain voltage limits" (Low Voltage Directive)
- 2014/34/EU "Equipment and protective systems intended for use in potentially explosive atmospheres" (Explosion Protection Directive)
- For ET 200SP fail-safe modules, the following also applies: 2006/42/EC "Machinery Directive"

The originals of the declarations of conformity are kept available by us for the responsible supervisory authorities.

Note on the EMC Directive:

In terms of their interference emissions, SIMATIC products are designed for industrial applications.

If individual products deviate from this specification, it is noted in the catalog with the products.

The installation instructions in the manuals must be adhered to when installing and operating the products described in this catalog. These contain, for example, important information on installation in cabinets and on the use of shielded cables.

Notes for machine manufacturers

The SIMATIC automation system is not a machine within the context of the EU machine guidelines. Therefore a declaration of conformity with regard to the EU machine directive 89/392/EEC or 2006/42/EU (new edition, applicable from end of 2009) may not be provided for SIMATIC.

The EU machine directive regulates the requirements placed on a machine or a part thereof. A machine is understood for the purposes of this guideline to be a combination of interconnected parts or mechanisms (see also EN 292-1, Paragraph 3.1).

SIMATIC is part of the electrical equipment of a machine, and must therefore be integrated into the evaluation of the complete machine by the machine manufacturer.

As electrical equipment, SIMATIC is subject to the low-voltage directive which, as a "total safety directive", covers all dangers just like the machine directive.

The EN 60204-1 standard (safety of machines, general requirements for the electrical equipment of machines) is applicable to the electrical equipment of machines.

The following table will help you in the provision of your declaration of conformity, and shows which criteria according to EN 60204-1 (2006-06) apply to SIMATIC. You can obtain further information from the enclosed declaration of conformity according to the low-voltage and EMC directives (with list of included standards).

EN 60204-1	Topic/criterion	Notes
Paragraph 4	General requirements	The requirements are met when the equipment is assembled/ installed in accordance with the installation guidelines. Please note the relevant information in the manuals.
Paragraph 11.2	Digital input/output interfaces	The requirements are met
Paragraph 12.3	Programmable equipment	The requirements are met when the equipment is installed in lockable cabinets to protect against alteration of the memory contents by unauthorized persons
Paragraph 20.4	Voltage tests	The requirements are met

Certificates, authorizations, approbations, declarations of conformity

An overview of the certificates available for SIMATIC products (CE, UL, CSA, FM, shipping authorizations) can be found in the internet at

<http://www.siemens.com/simatic/certificates>

The lists are continuously updated. The data for products which have not yet been included in the overview is continuously collected and prepared for the subsequent edition.

You can also find certificates, approbations, verification certificates or characteristic curves under Product support "Entry list"

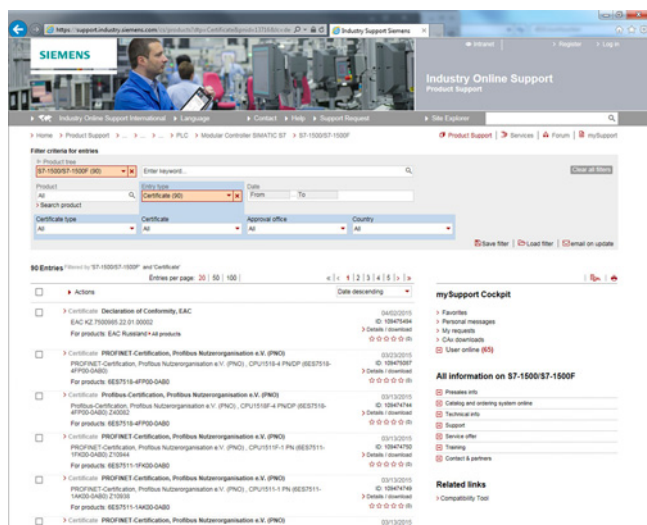

or by going directly to the Link Box:

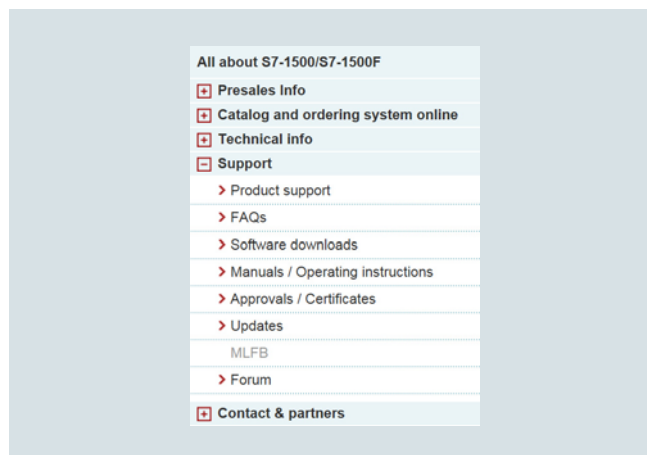

Quality management

The quality management system of the Industry Sector, Industry Automation Division, complies with the international standard ISO 9001.

The products and systems described in this catalog are sold under application of a quality management system certified by DQS in accordance with DIN EN ISO 9001.

The DQS certificate is recognized in all IQ Net countries.

DQS Registered Certificate No.:

Siemens AG

- DF FA
Reg. No.: 001323 QM15

Appendix

Siemens Automation Cooperates with Education (SCE)

Teaching made easy - Comprehensive support on the way to Industry 4.0

Knowledge & technology – the keystones to success in digitalization



Digitalization is quickly and radically changing our world. What does this mean for education?

In the world of Industry 4.0, companies can expect a host of new opportunities and challenges. New systems are verified on the spot through simulations. Automated mass production processes can make every product on the conveyor belt a unique product.

New products are now market-ready much faster. Siemens is shaping this transformation as a technology leader in the field of automation and process lifecycle management (PLM).

These new digitalization processes are changing the know-how requirements for employees. Many educational institutions are facing the challenge of conveying Industry 4.0 know-how as part of their teaching and training. The Siemens Automation Cooperates with Education (SCE) program is supporting educators on the way to Industry 4.0.

The SCE digitalization concept for educators

The SCE digitalization concept presented here shows how digitalization can be implemented in educational institutions – from vocational schools to universities.

Digitalization (or Industry 4.0) know-how is now introduced through CAx and cloud technologies. It is founded on the basics of automation, such as digital technologies, PLC and information technologies, and on advanced automation and industrial communication technologies.

The level of digitalization knowledge can be weighted, depending on the vocational field or branch of study – e.g. mechanical engineering, automation engineering or computer science.

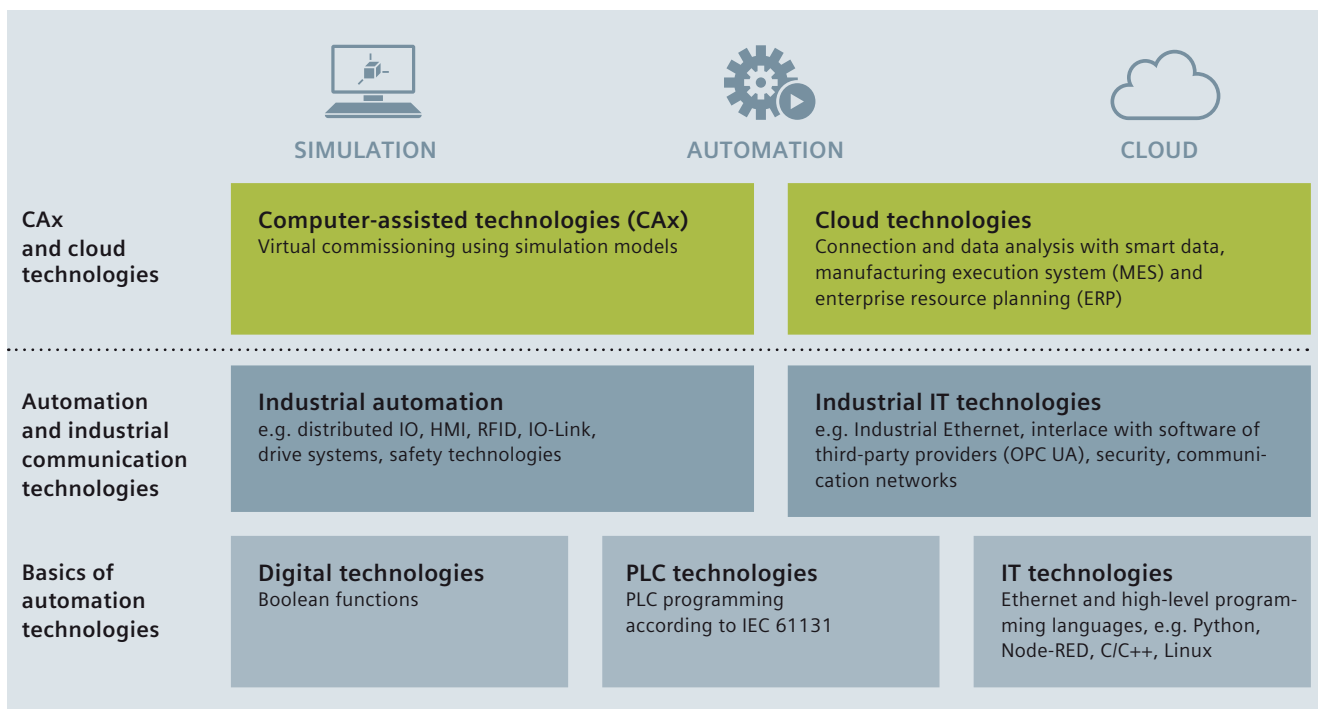

The SCE digitalization concept for educators (continued)

As part of their project work, students at Vocational School 2 in Wolfsburg, Germany, have implemented the three levels of the SCE Industry 4.0 concept. A virtual twin created with the Siemens NX Mechatronics Designer (MCD) CAD software was used for the design and virtual commissioning. This enables fast and efficient assembly of the real automation system, e.g. with SIMATIC S7-1500/ET 200SP/RFID, for use in classes. Production data, such as the number of bottles filled, production date and system parameters, are uploaded to a cloud using SIMATIC IOT2000.

[siemens.com/iot2020](https://www.siemens.com/iot2020)

[siemens.com/nx](https://www.siemens.com/nx)

The SCE offers**Learning and training documents**

More than 100 didactically prepared learning and training documents are available through SCE and incorporate the digitalization concept. They are designed for use in classes, but can also be customized or used for individual study. These documents are available for free download, most of them in 7 languages.

[siemens.com/sce/documents](https://www.siemens.com/sce/documents)

Educator courses

Excellent teaching content is needed to introduce students to digitalization. For this purpose, SCE holds educator courses in certain regions. Based on our learning and training documents and through practical exercises, educators acquire the latest Industry 4.0 know-how.

[siemens.com/sce/courses](https://www.siemens.com/sce/courses)

**Trainer packages**

The 90 SCE trainer packages help educators teaching and implementing the SCE digitalization concept. Trainer packages comprise specially compiled, genuine Siemens hardware and software products. The trainer packages are based on the learning and training documents and are offered to schools, colleges and universities at special terms.

[siemens.com/sce/tp](https://www.siemens.com/sce/tp)

Support for your projects / textbooks

We support you on selected projects with advice and assistance from SCE contact partners.

As a special service, we support textbook authors. We maintain a list of textbooks on the SCE website.

[siemens.com/sce/contact](https://www.siemens.com/sce/contact)

[siemens.com/sce/books](https://www.siemens.com/sce/books)

Appendix

Siemens Automation Cooperates with Education (SCE)

Teaching made easy - Comprehensive support on the way to Industry 4.0

Partnerships for proliferation of Industry 4.0 in education



Partnership with WorldSkills

As a technology powerhouse, we support vocational training of students around the world. Since 2010, we have partnered with WorldSkills as a Global Industry Partner in order to amplify this cause.

WorldSkills is an international organization whose mission is to raise the profile and recognition of skilled people, and show how important vocational skills are in achieving economic growth and personal success. Every two years, WorldSkills hosts the world championships of skills.

Siemens provides the competitors with automation products, such as SIMATIC S7-1500 and LOGO!, for the disciplines: industrial control, electrical installations, Polymechanics/Automation and manufacturing technology.

The next international skill competitions are scheduled for Shanghai/China, in 2021. Additionally, we support selected continental and regional competitions.

[siemens.com/worldskills](https://www.siemens.com/worldskills)



Partnerships with educators

We provide support to educators and educational organizations in the form of one-on-one advice through SCE contact partners and Siemens experts as well as long-term cooperation.

[siemens.com/sce/contact](https://www.siemens.com/sce/contact)

Partnerships with producers of learning systems

For practical training in classrooms and labs, numerous producers of learning systems offer a wide range of complete didactic solutions based on SCE trainer packages.

[siemens.com/sce/partner](https://www.siemens.com/sce/partner)

Information portal



To facilitate your teaching assignment and/or for selfstudy, we offer educators and students a comprehensive SCE information portal. At this portal you have quick access to all SCE offers, e.g. learning and training documents including projects, Getting Started information, videos, manuals, trial software and newsletters.

[siemens.com/sce](https://www.siemens.com/sce)

SIEMENS

Global Industry
Partner of
WorldSkills
International

worldskills

Overview

**Siemens Solution and Approved Partner –
Partners for your success**Highest competence in automation and drive technology

Siemens works closely together with selected partner companies around the world in order to ensure that customer requirements for all aspects of automation and drives are fulfilled as best as possible – wherever you are, and whatever the time.

We place great value on our customers acting in accordance with the same ideals which characterize Siemens as a whole: Competence, professionalism and quality. That is why continuous development through qualification and certification measures in line with global standards is a central aspect of our Partner Program. This means that with our partners, you benefit from the same high quality standards all over the world. The partner emblem is the symbol for tried and tested quality.

The partner network for industry

The Siemens Partner Program offers you expertise and experience close at hand.

Within our global network, we distinguish between Solution Partners and Approved Partners. We currently work with more than 1,500 Solution Partners around the world. Our network of over 150 Approved Partners continues to grow. In more than 80 countries worldwide

Siemens Solution Partner – Automation Drives

At present we are working with more than 1,500 **Solution Partners** worldwide. They are characterized by extensive application, system and sector knowledge, as well as proven project experience, and are able to implement future-proof tailored solutions of the highest quality, based on our product and system portfolio.

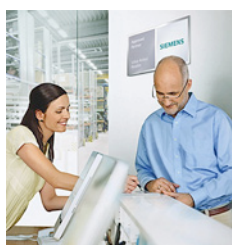
Siemens Approved Partner – Value Added Reseller

With their detailed technical knowledge, **Siemens Approved Partners – Value Added Resellers** offer a combination of products and services that range from specialist technologies and customized modifications to the provision of high-quality system and product packages. They also provide qualified technical support and assistance.

Siemens Approved Partner – Industry Services

Siemens Approved Partner – Industry Services: put their unique expertise entirely at the service of enhancing your productivity and can be instrumental in ensuring the availability of your plants.

Partner Finder

The ideal partner for your task is just a mouse click away!

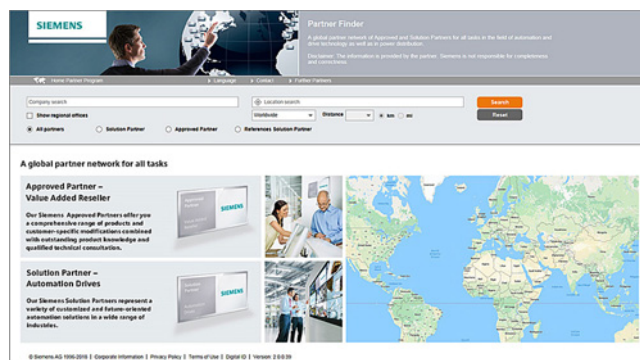

In the Siemens global Solution Partner program, customers are certain to find the optimum partner for their specific requirements – with no great effort. The Partner Finder is basically a comprehensive database that showcases the profiles of all our partners.

Easy selection:

Set filters in the search screen form according to the criteria that are relevant to you. You can also directly enter the name of an existing partner.

Skills at a glance:

Gain a quick insight into the specific competencies of any particular partner with the reference reports.

Direct contact option:

Use our electronic query form:

www.siemens.com/partnerfinder

Additional information of the Siemens Partners for industry is available online at:

www.siemens.com/partnerprogram

Appendix

Partners

Partners at Siemens

Overview

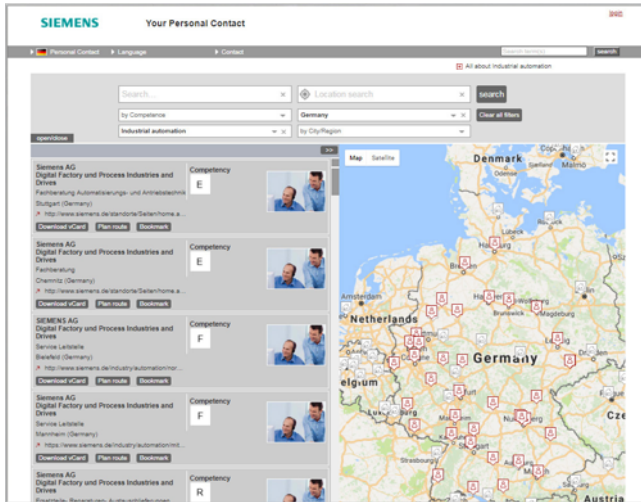

At your service locally, around the globe for consulting, sales, training, service, support, spare parts on the entire portfolio of Digital Industries.

Your partner can be found in our Personal Contacts Database at: www.siemens.com/automation-contact

You start by selecting

- the required competence,
- products and branches,
- a country and a city

or by a

- location search or free text search.

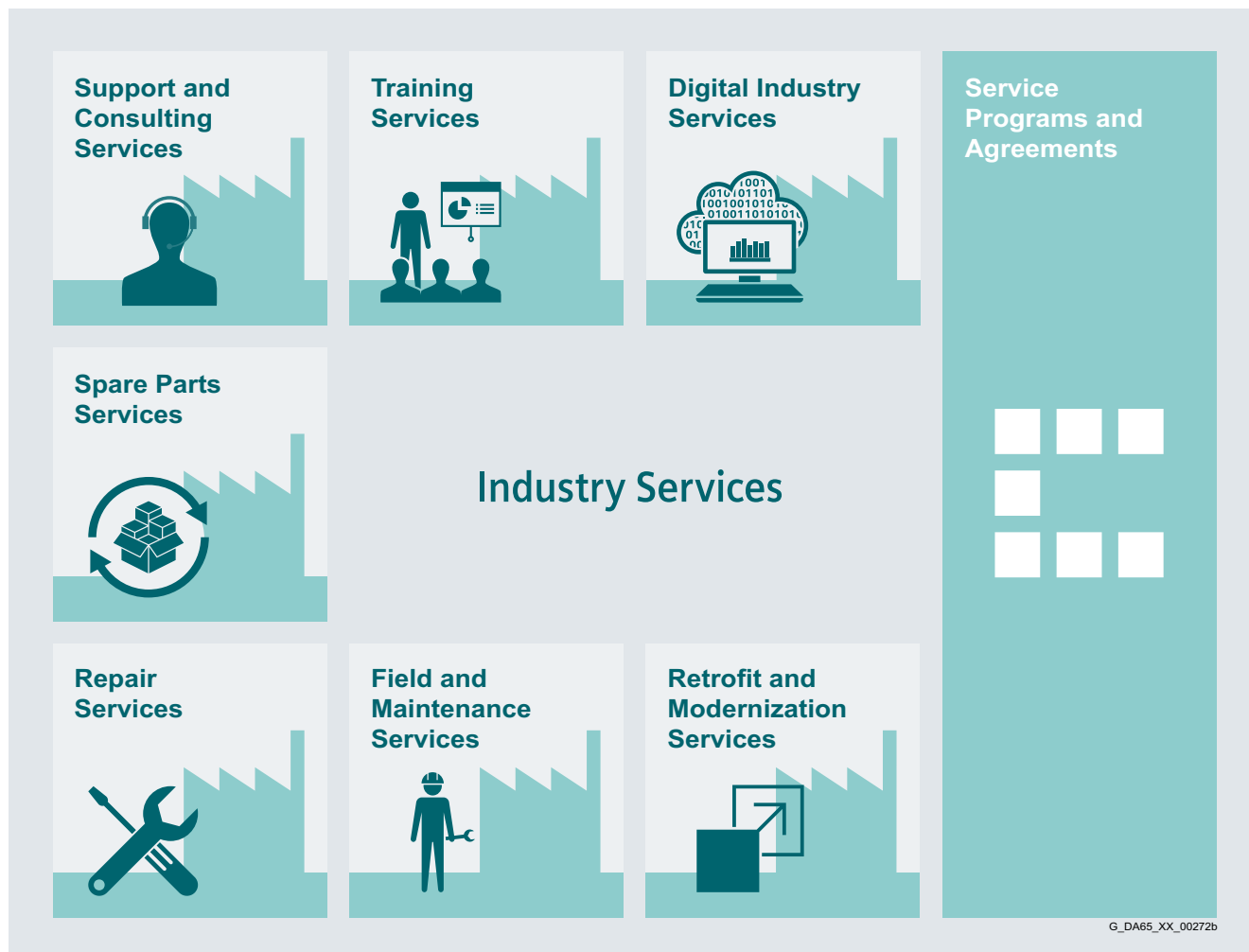
Overview

Keep your business running and shaping your digital future – with Industry Services

Optimizing the productivity of your equipment and operations can be a challenge, especially with constantly changing market conditions. Working with our service experts makes it easier. We understand your industry's unique processes and provide the services needed so that you can better achieve your business goals.

You can count on us to maximize your uptime and minimize your downtime, increasing your operations' productivity and reliability. When your operations have to be changed quickly to meet a new demand or business opportunity, our services give you the flexibility to adapt. Of course, we take care that your production is protected against cyber threats. We assist in keeping your operations as energy and resource efficient as possible and reducing your total cost of ownership. As a trendsetter, we ensure that you can capitalize on the opportunities of digitalization and by applying data analytics to enhance decision making: You can be sure that your plant reaches its full potential and retains this over the longer lifespan.

You can rely on our highly dedicated team of engineers, technicians and specialists to deliver the services you need – safely, professionally and in compliance with all regulations. We are there for you, where you need us, when you need us.

www.siemens.com/industryservices

Appendix

Industry Services

Industry Services – Portfolio overview

Overview



Digital Industry Services

Digital Industry Services make your industrial processes transparent to gain improvements in productivity, asset availability, and energy efficiency.

Production data is generated, filtered and translated with intelligent analytics to enhance decision-making.

This is done whilst taking data security into consideration and with continuous protection against cyber-attack threats.

<https://www.siemens.com/global/en/home/products/services/industry/digital-services.html>

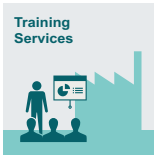

Training Services

From the basics and advanced to specialist skills, SITRAIN courses provide expertise right from the manufacturer – and encompass the entire spectrum of Siemens products and systems for the industry.

Worldwide, SITRAIN courses are available wherever you need a training course in more than 170 locations in over 60 countries.

<https://support.industry.siemens.com/cs/ww/en/sc/2226>



Support and Consulting Services

Industry Online Support site for comprehensive information, application examples, FAQs and support requests.

Technical and Engineering Support for advice and answers for all inquiries about functionality, handling, and fault clearance. The Service Card as prepaid support for value added services such as Priority Call Back or Extended Support offers the clear advantage of quick and easy purchasing.

Information & Consulting Services, e.g. SIMATIC System Audit; clarity about the state and service capability of your automation system or Lifecycle Information Services; transparency on the lifecycle of the products in your plants.

<https://support.industry.siemens.com/cs/ww/en/sc/2235>



Spare Parts

Spare Parts Services are available worldwide for smooth and fast supply of spare parts – and thus optimal plant availability. Genuine spare parts are available for up to ten years. Logistic experts take care of procurement, transport, custom clearance, storage and order manage-

ment. Reliable logistics processes ensure that components reach their destination as needed.

Since not all spare parts can be kept in stock at all times, Siemens offers a preventive measure for spare parts provisioning on the customer's premises with optimized **Spare Parts Packages** for individual products, custom-assembled drive components and entire integrated drive trains – including risk consulting.

Asset Optimization Services help you design a strategy for parts supply where your investment and carrying costs are reduced and the risk of obsolescence is avoided.

<https://support.industry.siemens.com/cs/ww/en/sc/2110>



Repair Services

Repair Services are offered on-site and in regional repair centers for fast restoration of faulty devices' functionality.

Also available are extended repair services, which include additional diagnostic and repair measures, as well as emergency services.

<https://support.industry.siemens.com/cs/ww/en/sc/2154>



Field and Maintenance Services

Siemens specialists are available globally to provide expert field and maintenance services, including commissioning, functional testing, preventive maintenance and fault clearance.

All services can be included in customized service agreements with defined reaction times or fixed maintenance intervals.

<https://support.industry.siemens.com/cs/ww/en/sc/2265>



Retrofit and Modernization Services

Provide a cost-effective solution for the expansion of entire plants, optimization of systems or upgrading existing products to the latest technology and software, e.g. migration services for automation systems.

Service experts support projects from planning through commissioning and, if desired over the entire extended lifespan, e.g. Retrofit for Integrated Drive Systems for an extended lifetime of your machines and plants.

<https://support.industry.siemens.com/cs/ww/en/sc/2286>



Service Programs and Agreements

A technical Service Program or Agreement enables you to easily bundle a wide range of services into a single annual or multi-year agreement.

You pick the services you need to match your unique requirements or fill gaps in your organization's maintenance capabilities.

Programs and agreements can be customized as KPI-based and/or performance-based contracts.

<https://support.industry.siemens.com/cs/ww/en/sc/2275>

Overview

Online Support – fast, intuitive, whenever you want, wherever you need



Web



support.industry.siemens.com

App





Scan the QR code for information on our Online Support app.



	<p>FAQ / Application examples</p> <p>Information about industrial products, programming and configuration as well as application examples</p>
	<p>Technical information</p> <p>Videos, documentation, manuals, updates, product notes, compatibility tool, certificates, planning data such as dimensional drawings, product data, 3D models</p>
	<p>Forum</p> <p>Exchange information and experience with other users and experts</p>

Online Support for Siemens Industry Products

Siemens Industry and Online Support with some 1.7 million visitors per month is one of the most popular web services provided by Siemens. It is the central access point for comprehensive technical know-how about products, systems and services for automation and drives applications as well as for process industries.

In connection with the challenges and opportunities related to digitalization you can look forward to continued support with innovative offerings.

Appendix

Software licenses

Overview

Software types

Software requiring a license is categorized into types. The following software types have been defined:

- Engineering software
- Runtime software

Engineering software

This includes all software products for creating (engineering) user software, e.g. for configuring, programming, parameterizing, testing, commissioning or servicing.

Data generated with engineering software and executable programs can be duplicated for your own use or for use by third-parties free-of-charge.

Runtime software

This includes all software products required for plant/machine operation, e.g. operating system, basic system, system expansions, drivers, etc.

The duplication of the runtime software and executable programs created with the runtime software for your own use or for use by third-parties is subject to a charge.

You can find information about license fees according to use in the ordering data (e.g. in the catalog). Examples of categories of use include per CPU, per installation, per channel, per instance, per axis, per control loop, per variable, etc.

Information about extended rights of use for parameterization/configuration tools supplied as integral components of the scope of supply can be found in the readme file supplied with the relevant product(s).

License types

Siemens Industry Automation & Drive Technologies offers various types of software license:

- Floating license
- Single license
- Rental license
- Rental floating license
- Trial license
- Demo license
- Demo floating license

Floating license

The software may be installed for internal use on any number of devices by the licensee. Only the concurrent user is licensed. The concurrent user is the person using the program. Use begins when the software is started. A license is required for each concurrent user.

Single license

Unlike the floating license, a single license permits only one installation of the software per license.

The type of use licensed is specified in the ordering data and in the Certificate of License (CoL). Types of use include for example per instance, per axis, per channel, etc.

One single license is required for each type of use defined.

Rental license

A rental license supports the "sporadic use" of engineering software. Once the license key has been installed, the software can be used for a specific period of time (the operating hours do not have to be consecutive).

One license is required for each installation of the software.

Rental floating license

The rental floating license corresponds to the rental license, except that a license is not required for each installation of the software. Rather, one license is required per object (for example, user or device).

Trial license

A trial license supports "short-term use" of the software in a non-productive context, e.g. for testing and evaluation purposes. It can be transferred to another license.

Demo license

The demo license support the "sporadic use" of engineering software in a non-productive context, for example, use for testing and evaluation purposes. It can be transferred to another license. After the installation of the license key, the software can be operated for a specific period of time, whereby usage can be interrupted as often as required.

One license is required per installation of the software.

Demo floating license

The demo floating license corresponds to the demo license, except that a license is not required for each installation of the software. Rather, one license is required per object (for example, user or device).

Certificate of License (CoL)

The CoL is the licensee's proof that the use of the software has been licensed by Siemens. A CoL is required for every type of use and must be kept in a safe place.

Downgrading

The licensee is permitted to use the software or an earlier version/release of the software, provided that the licensee owns such a version/release and its use is technically feasible.

Delivery versions

Software is constantly being updated. The following delivery versions

- PowerPack
- Upgrade

can be used to access updates.

Existing bug fixes are supplied with the ServicePack version.

PowerPack

PowerPacks can be used to upgrade to more powerful software. The licensee receives a new license agreement and CoL (Certificate of License) with the PowerPack. This CoL, together with the CoL for the original product, proves that the new software is licensed.

A separate PowerPack must be purchased for each original license of the software to be replaced.

Upgrade

An upgrade permits the use of a new version of the software on the condition that a license for a previous version of the product is already held.

The licensee receives a new license agreement and CoL with the upgrade. This CoL, together with the CoL for the previous product, proves that the new version is licensed.

A separate upgrade must be purchased for each original license of the software to be upgraded.

Overview**ServicePack**

ServicePacks are used to debug existing products. ServicePacks may be duplicated for use as prescribed according to the number of existing original licenses.

License key

Siemens Industry Automation & Drive Technologies supplies software products with and without license keys.

The license key serves as an electronic license stamp and is also the "switch" for activating the software (floating license, rental license, etc.).

The complete installation of software products requiring license keys includes the program to be licensed (the software) and the license key (which represents the license).

Software Update Service (SUS)

As part of the SUS contract, all software updates for the respective product are made available to you free of charge for a period of one year from the invoice date. The contract will automatically be extended for one year if it is not canceled three months before it expires.

The possession of the current version of the respective software is a basic condition for entering into an SUS contract.

You can download explanations concerning license conditions from https://mall.industry.siemens.com/legal/ww/en/terms_of_trade_en.pdf

Appendix

Notes

1. General Provisions

By using this catalog you can purchase products (hardware, software and services) described therein from Siemens Aktiengesellschaft subject to the following Terms and Conditions of Sale and Delivery (hereinafter referred to as "T&C"). Please note that the scope, the quality and the conditions for supplies and services, including software products, by any Siemens entity having a registered office outside Germany, shall be subject exclusively to the General Terms and Conditions of the respective Siemens entity. The following T&C apply exclusively for orders placed with Siemens Aktiengesellschaft, Germany.

1.1 For customers with a seat or registered office in Germany

For customers with a seat or registered office in Germany, the following terms and conditions apply subordinate to T&C:

- for products, which include specific terms and conditions in the description text, these specific terms and conditions shall apply and subordinate thereto,
- for installation work the "General Conditions for Erection Works – Germany"¹⁾ ("Allgemeine Montagebedingungen – Deutschland" (currently only available in German)) and/or
- for stand-alone software products and software products forming a part of a product or project, the "General License Conditions for Software Products for Automation and Drives for Customers with a Seat or registered Office in Germany"¹⁾ and/or
- for consulting services the "General Terms and Conditions for Consulting Services of the Division DF – Germany"¹⁾ and/or
- for other supplies and/or services the "General Conditions for the Supply of Products and Services of the Electrical and Electronics Industry"¹⁾.

In case such supplies and/or services should contain Open Source Software, the conditions of which shall prevail over the "General Conditions for the Supply of Products and Services of the Electrical and Electronics Industry"¹⁾, a notice will be contained in the scope of delivery in which the applicable conditions for Open Source Software are specified. This shall apply mutatis mutandis for notices referring to other third party software components.

1.2 For customers with a seat or registered office outside Germany

For customers with a seat or registered office outside Germany, the following terms and conditions apply subordinate to T&C:

- for products, which include specific terms and conditions in the description text, these specific terms and conditions shall apply and subordinate thereto,
- for services the "International Terms & Conditions for Services"¹⁾ supplemented by "Software Licensing Conditions"¹⁾ and/or
- for consulting services the "General Terms and Conditions for Consulting Services of the Division DF – Germany"¹⁾ and/or
- for other supplies of hard- and software the "International Terms & Conditions for Products"¹⁾ supplemented by "Software Licensing Conditions"¹⁾

1.3 For customers with master or framework agreement

To the extent our supplies and/or services offered are covered by an existing master or framework agreement, the terms and conditions of that agreement shall apply instead of T&C.

2. Prices

The prices are in € (Euro) ex point of delivery, exclusive of packaging.

The sales tax (value added tax) is not included in the prices. It shall be charged separately at the respective rate according to the applicable statutory legal regulations.

Prices are subject to change without prior notice. We will charge the prices valid at the time of delivery.

To compensate for variations in the price of raw materials (e.g. silver, copper, aluminum, lead, gold, dysprosium and neodym), surcharges are calculated on a daily basis using the so-called metal factor for products containing these raw materials. A surcharge for the respective raw material is calculated as a supplement to the price of a product if the basic official price of the raw material in question is exceeded.

The metal factor of a product indicates the basic official price (for those raw materials concerned) as of which the surcharges on the price of the product are applied, and with what method of calculation.

An exact explanation of the metal factor can be downloaded at: https://mall.industry.siemens.com/legal/ww/en/terms_of_trade_en.pdf

To calculate the surcharge (except in the cases of dysprosium and neodym), the official price from the day prior to that on which the order was received or the release order was effected is used.

To calculate the surcharge applicable to dysprosium and neodym ("rare earths"), the corresponding three-month basic average price in the quarter prior to that in which the order was received or the release order was effected is used with a one-month buffer (details on the calculation can be found in the explanation of the metal factor).

3. Additional Terms and Conditions

The dimensions are in mm. In Germany, according to the German law on units in measuring technology, data in inches apply only to devices for export.

Illustrations are not binding.

Insofar as there are no remarks on the individual pages of this catalog – especially with regard to data, dimensions and weights given – these are subject to change without prior notice.

¹⁾ The text of the Terms and Conditions of Siemens AG can be downloaded at https://mall.industry.siemens.com/legal/ww/en/terms_of_trade_en.pdf

Appendix

Conditions of sale and delivery

4. Export Regulations

We shall not be obligated to fulfill any agreement if such fulfillment is prevented by any impediments arising out of national or international foreign trade or customs requirements or any embargoes and/or other sanctions.

Export may be subject to license. We shall indicate in the delivery details whether licenses are required under German, European and US export lists.

Our products are controlled by the U.S. Government (when labeled with "ECCN" unequal "N") and authorized for export only to the country of ultimate destination for use by the ultimate consignee or end-user(s) herein identified. They may not be resold, transferred, or otherwise disposed of, to any other country or to any person other than the authorized ultimate consignee or end-user(s), either in their original form or after being incorporated into other items, without first obtaining approval from the U.S. Government or as otherwise authorized by U.S. law and regulations.

The export indications can be viewed in advance in the description of the respective goods on the Industry Mall, our online catalog system. Only the export labels "AL" and "ECCN" indicated on order confirmations, delivery notes and invoices are authoritative.

Products labeled with "AL" unequal "N" are subject to European / national export authorization. Products without label, with label "AL:N" / "ECCN:N", or label "AL:9X9999" / "ECCN: 9X9999" may require authorization from responsible authorities depending on the final end-use, or the destination.

If you transfer goods (hardware and/or software and/or technology as well as corresponding documentation, regardless of the mode of provision) delivered by us or works and services (including all kinds of technical support) performed by us to a third party worldwide, you must comply with all applicable national and international (re-)export control regulations.

If required for the purpose of conducting export control checks, you (upon request by us) shall promptly provide us with all information pertaining to the particular end customer, final disposition and intended use of goods delivered by us respectively works and services provided by us, as well as to any export control restrictions existing in this relation.

The products listed in this catalog may be subject to European/German and/or US export regulations. Any export requiring approval is therefore subject to authorization by the relevant authorities.

Errors excepted and subject to change without prior notice.

Selection and ordering at Siemens Industry Mall, Catalog CA 01, downloading and ordering catalogs

Easy product selection and ordering: Industry Mall and Interactive Catalog CA 01

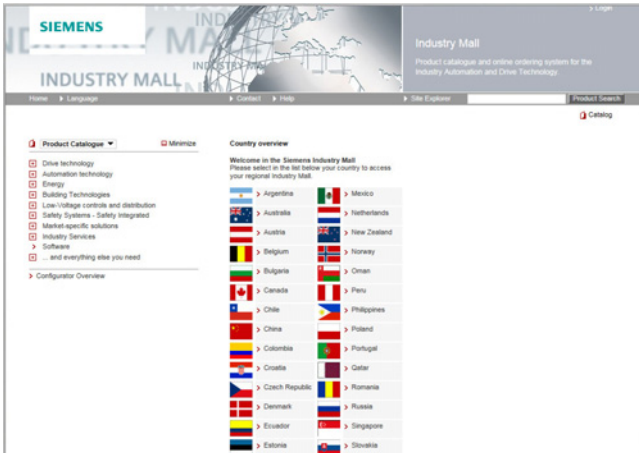

Industry Mall

The Industry Mall is a Siemens AG Internet ordering platform. It provides you with online access to a comprehensive product spectrum that is presented in an informative, well-organized way.

Powerful search functions help you select the required products, while configurators enable you to configure complex product and system components quickly and easily. CAx data are also available for you to use.

Data transfer allows the entire procedure, from selection through ordering to tracking and tracing, to be carried out online. Availability checks, individual customer discounting, and quotation preparation are also possible.

www.siemens.com/industrymall



Interactive Catalog CA 01 – Products for automation and drives

The Interactive Catalog CA 01 combined with the Siemens Industry Mall unites the benefits of offline and online media in one application – the performance of an offline catalog with the availability of a wide range of up-to-date information on the Internet.

Select products and assemble orders using the CA 01, determine the availability of the selected products, and track and trace them via the Industry Mall.

Information and download:

www.siemens.com/automation/ca01

Downloading catalogs

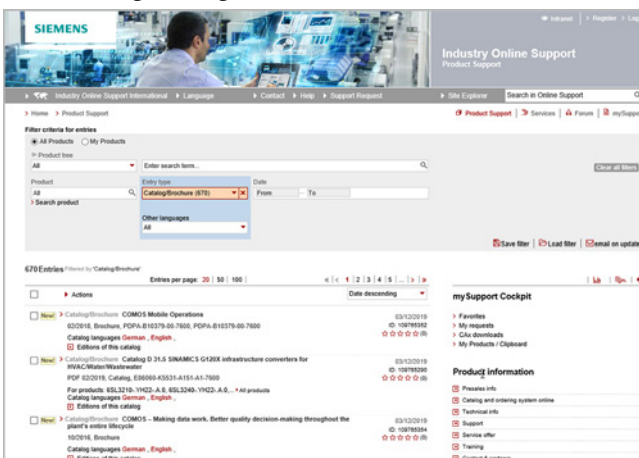

Siemens Industry Online Support

You can download catalogs and brochures in PDF format from Siemens Industry Online Support without having to register.

The filter box makes it possible to perform targeted searches.

www.siemens.com/industry-catalogs

Ordering printed catalogs



Please contact your local Siemens branch if you are interested in ordering printed catalogs.

Addresses can be found at

www.siemens.com/automation-contact

Siemens AG

Digital Industries
Factory Automation
P.O. Box 4848
90026 Nuremberg
Germany

PDF (E86060-K4670-A151-B1-7600)
KG 0520 PDF 286 En
Produced in Germany

© Siemens 2020

Siemens Industry Inc.

100 Technology Drive
Alpharetta, GA 30005
United States

Subject to changes and errors. The information given in this document only contains general descriptions and/or performance features which may not always specifically reflect those described, or which may undergo modification in the course of further development of the products. The requested performance features are binding only when they are expressly agreed upon in the concluded contract.

All product designations may be trademarks or product names of Siemens AG or other companies whose use by third parties for their own purposes could violate the rights of the owners.

Siemens provides products and solutions with industrial security functions that support the secure operation of plants, systems, machines and networks.

In order to protect plants, systems, machines and networks against cyber threats, it is necessary to implement – and continuously maintain – a holistic, state-of-the-art industrial security concept. Siemens' products and solutions constitute one element of such a concept.

Customers are responsible for preventing unauthorized access to their plants, systems, machines and networks. Such systems, machines and components should only be connected to an enterprise network or the internet if and to the extent such a connection is necessary and only when appropriate security measures (e.g. firewalls and/or network segmentation) are in place.

For additional information on industrial security measures that may be implemented, please visit

<http://www.siemens.com/industrialsecurity>.

Siemens' products and solutions undergo continuous development to make them more secure. Siemens strongly recommends that product updates are applied as soon as they are available and that the latest product versions are used. Use of product versions that are no longer supported, and failure to apply the latest updates may increase customer's exposure to cyber threats.

To stay informed about product updates, subscribe to the Siemens Industrial Security RSS Feed under

<http://www.siemens.com/industrialsecurity>.